

B.U.S.F. - F.S.U.B.



**RESULTATS SAISON SPORTIVE
2013-2014
UITSLAGEN**



	Disciplines	Dates	Lieux	Organisateurs	Participants Enseignement Supérieur	Institutions représentées
	Athlétisme indoor	7/02/2014	Topsportal de Gand		304	41
	Athlétisme outdoor	1/05/2014	RFCL Naimette-Xhovémont		310	30
	Badminton	12/03/2014	GUSB Gent		76	21
	Course d'Orientation	1/12/2013	Salle Du Patro à Thuin		17	9
	Cyclisme Hommes	19/04/2014	Zutendaal		47	12 minimum
	Cyclisme Dames	1/05/2014	Boortmeerbeek		16	7 minimum
	Duathlon	30/03/2014	Kluisbergen		Annulé	Annulé
	Echecs	19/02/2014	KaHo Sint Lieven		19	10
	Escalade	12/03/2014	Espace Grimpe Charleroi		9 dont 1 seul néerlandophone	4
	Escrime	16/02/2014	Athénée de Gembloux		81	13
	Frisbee (Ultimate)	25/06/2014	Hogeschool Gent		7 équipes	7
	Gymnastique	12/03/2014	Blocry à Louvain-La-Neuve		48	8
	Judo individuel	2/04/2014	Hall sportif Katho Reno à Tourhout		79	23
	Judo par équipe	27/11/2013	ERM / KMS		6 équipes	5
	Natation	19/03/2014	Piscine de Ugent		120	14
	Rugby VII	24/04/2014	Kituro Rugby Club		9 équipes hommes 4 équipes dames	7 (hommes) 4 (dames)
	Tennis de Table	28/11/2013	Centre sportif KULeuven à Heverlee		78	21
	Trailrunning	30/11/2013	Kluisbergen		23	14
	Triathlon- Duathlon*	18/05/2014	Centre ADEPS "La Marlette" à Seneffe		29	10

* Suite à des problèmes de qualité de l'eau, seules les épreuves vélo et course à pied se sont disputées.

Vendredi 7 février 2014

Championnat Enseignement Supérieur

INFORMATIONS GENERALES :

* **HORAIRE** : dès 17h30 jusque +- 23h.

* **LIEU** : **Topsportal Vlaanderen à Gand**,
Zuiderlaan 14, 9000 Gent.

* **INFOS** :

http://www.rcgent.be/index.php?option=com_content&view=article&id=161%3Abk-univ-indoor-2011&catid=1%3Ahome-page&Itemid=99
e-mail : rcg@val.be



INSCRIPTIONS :

En ligne via le lien : http://www.rcgent.be/index.php?option=com_forme&fid=4.

Clôture le vendredi 31/01/2014, 16h.

Attention, clôture anticipative possible sous réserve des disponibilités.

Le responsable sport de ton institution recevra une confirmation de ton inscription par mail.

Inscris-toi sans attendre grâce à ton smartphone et ce QR-CODE !



Résultats du Championnat FSUB d' Athlétisme indoor

Gent

Vendredi 7 février 2014



BK STUDENTEN TOPSPORTHAL GENT

7/02/2014

mmv KRCGent atletiek

60m horden 0,84m Sen V Time :18:17

Heat:1

1	1244	ACKERMAN Aurelie	89	BEL	10.48
2	1697	DEBERSAQUES Sarah	94	ARTE	10.60
3	9991	CORRE Morgane	94	HEPL	11.15
4	9838	WILLEMS Madeline	92	UCL	11.93

60m horden 0,84m Sen V Time :18:17

Heat:2

1	1461	LEMMENS Karolien	89	KUL	9.37
2	406	VAN DEN BRULLE Kato	96	BEL	9.59
3	378	BIEBUYCK Mona	96	BEL	10.22
4	1966	CHEVALIER Alicia	93	UCL	10.47

60m horden 0,84m Sen V Time :18:17

Heat:3

1	9893	VAN PETERSEN Nancy	92	APHA	8.72
2	511	BRAHY Zo™	96	BEL	8.79
3	17	LAMMENS Shari	96	BEL	9.07
4	1619	TRUSSART Veronique	92	UCL	9.15
5	236	DE PAUW Yoika	95	UGEN	9.28
	1546	VERVAET Imke	93	UGEN	DNF

60m horden 0,84m Sen V Time :18:17

Heat:4

1	9837	WILLIAMS Suzanne	93	NED	8.41
2	9968	KROONENBURG Nicole	89	NED	8.51
3	1000	LINDEMANS Marjolein	94	HOGÉ	8.52
4	177	MISSINE Sarah	95	ARTE	8.54
5	1376	GRILLET Justien	05	UGEN	8.59
6	1249	DE MAITRE Ella	93	TMA	8.63
7	552	VANCAUWEMBERGHE Siliane	96	BEL	8.66
8	130	DE CONINCK Nenah	96	BEL	8.68

60m horden 1,067m Sen Men Time :18:19

Heat:1

1	9906	VAN KRUCHTEN Mike	87	NED	7.85
2	1876	DE BORGER Dario	92	BEL	7.87
3	501	DEGHELT Adrien		SMAC	7.89
4	2750	GOFFAUX Simon	89	UCL	8.60
	9902	SMET Koen	92	NED	DIS
	2167	HANJOUL Denis	91	KUL	DIS

60m horden 1,067m Sen Men Time :18:19

Heat:2

1	1336	TOMMELEIN Leander	94	KUL	8.69
2	315	DUMON Ewout	95	UGEN	8.79

3	2772	PARISIS JeanLoup	93	HELH	8.84
4	1992	VAN DE VELDE Koen	89	UGEN	8.87
5	2344	VAN CANNEYT Tijts	92	HOGE	9.01
6	1978	VERCAUTEREN Simon	92	HOGE	9.45
7	9961	PASSON Benoit	93	ULB	14.68

1500 meter Sen V Time :18:34

Heat:1

1	560	VAN DEN ABEELE Elodie	96	BEL	5:00.01
2	1878	STORDEUR Melanie	92	UL	5:03.88
3	1179	DE GROOTE Sarah	92	ARTE	5:36.04
4	135	CARREIN Febe	95	UGEN	5:43.69
5	1729	DELAFONTAINE Phebe	94	UGEN	5:55.05

1500 meter Sen Men Time :18:49

Heat:1

1	1927	BAETE Gieljan	90	ARTE	4:08.99
2	2842	NUTTENS Cyrille	94	HEPH	4:11.15
3	9970	KAZEMIER Derrick	92	NED	4:12.37
4	2705	SCARNIET Francois	05	UCL	4:14.78
5	9890	VANDAELE Stein	92	KHVI	4:16.55
6	2698	MERTZ Christopher	93	BEL	4:17.03
7	9998	MICHEL Maxime	92	UCL	4:23.85
8	9934	VAN DE WALLE Cedric	91	UGEN	4:28.22
9	1922	VAN APERS Mattias	93	APHA	4:34.25
10	9984	DELEEBEECK Joeri	90	KAHO	4:50.69
11	9961	PASSON Benoit	93	ULB	4:54.06

3000 meter Sen V Time :19:09

Heat:1

1	1491	VANTHILLO Britt	91	APHA	9:57.29
2	1879	DE COCK Florence	92	UCL	11:49.66
3	987	DEGENS Saskia	88	KHLI	12:20.16
	894	VAN HAVERE Evelin	93	KAHO	DNS

3000 meter Sen Men Time :19:31

Heat:1

1	3076	SOUGHOU Yassine	92	EPH	8:24.41
2	2655	DELGUSTE Martin	91	UCL	8:24.84
3	2556	FINTOLINI Dorian	93	HEPL	8:37.43
4	9942	STIFANOS Yared	94	NED	8:37.51
5	1425	LEYSEN Erwin	91	UH	8:41.75
6	1393	VAN DER KELEN Ward	94	EHB	8:42.97
7	682	RUSCART Benoit	95	HEPH	9:19.04
8	994	CEUPPENS Stef	92	UGEN	9:26.33
9	2553	GOVAERT Thomas	93	UGEN	9:37.46
10	1702	JANSSENS Sven	93	UA	9:39.59
11	2848	MAHIA Sebastien	86	UL	9:45.51
12	2917	NICODEME Thibault	92	ULG	9:58.85
13	2862	TIMMERMANN Alexandre	93	HELM	10:06.63
14	9987	DE LEEUW Danny	90	NED	10:27.03
15	9979	DONDJOU FOULEFACK Charli	82	UMON	10:58.37

60 meter Sen V Time :19:56

Heat:1

1	1157	VANHAEN Shana	93	KHLI	7.72
---	------	---------------	----	------	------

2	933	RYCKEBOER Eva	86	UGEN	8.68
3	935	CEULEMANS Marlies	93	APHA	8.72
4	2463	VAN DAMME Petra	78	UGEN	8.74
5	411	VAN POEL Esther	95	UGEN	8.94
6	9838	WILLEMS Madeline	92	UCL	9.23

60 meter Sen V Time :19:56

Heat:2

1	1830	LINS Noemie	94	HEG	8.37
2	858	VERMERSCH Skrolan	92	APHA	8.41
3	867	JANSSENS Karlijn	91	UGEN	8.46
4	352	DE LA MANE Marie	95	ARTE	8.60
5	1071	DEVILLE Sofie	94	HOGE	8.79
6	9936	VACHAUDEZ Estelle	90	ULB	9.30

60 meter Sen V Time :19:56

Heat:3

1	1461	LEMMENS Karolien	89	KUL	8.08
2	1091	DUPONT Louise	94	KATH	8.22
3	1444	BOUMKWO Jolien	93	UGEN	8.24
4	1976	HEMROULLE Pascaline	92	HEPL	8.42
5	1355	CLAES Jente	92	KDG	8.50
6	268	LAMBRECHTS Jana	95	ARTE	8.51
7	1201	VERVAET Paulien	94	KAHO	8.72
8	9980	D'HEYGERE Sarah	92	UMON	8.91

60 meter Sen V Time :19:56

Heat:4

1	859	JANSSENS Marijne	93	KUL	8.05
2	136	DEROLEZ Marie	95	APHA	8.17
3	2087	GATHON Florence	05		8.21
4	1195	HEIJNDRIKX Ines	93	UGEN	8.24
5	204	RUTSAERT Regine	95	APHA	8.24
6	301	BOGAERT Annelies	95	KAHO	8.27
7	1022	GROENEN Martine	94	UH	8.27
8	622	FLEURY Alice	95	UCL	8.35

60 meter Sen V Time :19:56

Heat:5

1	1357	DE GEEST Lize	91	UGEN	7.90
2	1382	VAN LEUVEN Wendy	86	UA	8.04
3	245	PAULISSEN Nel	95	BEL	8.07
4	1619	TRUSSART Veronique	92	UCL	8.10
5	1286	DE RUYCK Hanne	91	BEL	8.34

60 meter Sen V Time :19:56

Heat:6

1	1350	DAELEMANS Sofie	91	UGEN	7.83
2	9968	KROONENBURG Nicole	89	NED	7.86
3	1553	TAHON Charlotte	92	KUL	7.90
4	511	BRAHY Zo™	96	BEL	7.96
5	259	TESSENS Helena	95	VUB	8.26

60 meter Sen V Time :19:56

Heat:7

1	9949	SAMUEL Jamile	92	NED	7.35
---	------	---------------	----	-----	------

2	1248	RUTJENS Sarah	92	UGEN	7.53
3	9975	FARIAS Bruna	92		7.55
4	9978	DOPHEIDE Marit	90	NED	7.56
5	863	LEEMANS Jolien	94	UA	7.92
6	9893	VAN PETERSEN Nancy	92	APHA	7.94
7	9834	LOBO Miquella	94	NED	7.98

60 meter Sen Men Time :20:23

Heat:1

1	9999	DUQUESNE Jean Philippe	91	HESP	7.25
2	9985	DECAPMAKER Jan	92	KHVI	7.34
3	2735	LE MEN Benoit	93	UCL	7.46
4	9977	DOS SANTOS Sacha	94	HELB	7.73
5	1799	VANNESTE Bavo	94	KHVI	7.75
6	9966	LEBRETON Guillaume	93	HEPL	8.28

60 meter Sen Men Time :20:23

Heat:2

1	9996	BERGEZ Stefan	89	UGEN	7.45
2	2824	VAN DEN BROECK Emile	05	HELV	7.46
3	2925	BRABANT Jonathan	93	ULB	7.46
4	9993	CHEVAL Vincent	90	ULB	7.57
5	717	BARTHELEMY Thomas	05	BEL	7.61
6	1549	GHYSELINCK Ben	91	UGEN	7.76
7	9989	DAUBERCY Nicolas	94	ULB	7.79

60 meter Sen Men Time :20:23

Heat:3

1	9988	DE GROOT Dennis	83	NED	7.43
2	1868	VAN DEN BERGHE Ruben	89	ARTE	7.63
3	9915	VAN DER BRUGGEN Arvid	89	NED	7.65
4	324	VAN DE STEEN Matthias	95	UGEN	7.97
5	276	PIETERS Sven	95	BEL	8.07
	1035	MOTMANS Glenn	94	TMK	DIS

60 meter Sen Men Time :20:23

Heat:4

1	183	DE MEULEMEESTER Alan	95	UGEN	7.19
2	9973	HEERINGS Joep	90	NED	7.23
3	9822	SHUTSHA KASONGO Emmanuel	95	ULB	7.25
4	9982	DESMET Erwin	84	HEH	7.31
5	2167	HANJOUL Denis	91	KUL	7.39
6	2338	LYNEN Martijn	94	UH	7.54
7	2179	D'HAEMER Laurenz	88	BEL	7.65
8	9818	JACQUES Jerome	90	ICHE	7.72

60 meter Sen Men Time :20:23

Heat:5

1	1548	HUWEL Klaas	91	HOGA	7.04
2	2826	CALUWE Arnaud	05	HUB	7.28
3	2864	MAHIEU Sebastien	92	HEH	7.30
4	1814	MAES Gerben	94	HUB	7.32
5	1973	SANCTORUM Maxim	93	KHBO	7.35
6	128	VERMEIRE Joshi	95	UGEN	7.37
7	2110	HUYGHE Jon	93	UGEN	7.37
8	33	JANSSENS Kamiel	96	BEL	7.54

60 meter Sen Men Time :20:23

Heat:6

1	9965	MACAULAY Robert junior	90	EPH	7.18
2	410	ROSSAERT Michael	95	KAHO	7.22
3	1162	DE DECKER Bjorn	89	BEL	7.30
4	1468	DEFLEM Kenny	05	KUL	7.37
5	205	HERREGODTS Preben	95	HUB	7.45
6	2344	VAN CANNEYT Tijjs	92	HOGÉ	7.48
7	2811	LOPEZ CASTELLANOS Thomas	91	UMON	7.67

60 meter Sen Men Time :20:23

Heat:7

1	2637	RUFFACQ Quentin	89	BEL	7.06
2	2671	LORIS Lionel	91	ULB	7.15
3	2168	HANJOUŁ Benoît	05	KUL	7.20
4	421	DULLERS Jan	95	KHLI	7.24
5	2927	THOMAS Olivier	94	UCL	7.30
6	123	HENRY Laurent	95	APHA	7.31
7	3106	DIALLO Oumar	94	HELB	7.31
8	2854	DATOUSSAID Mehdi	90	ULB	7.32

60 meter Sen Men Time :20:23

Heat:8

1	3105	BROOȲAERTS Damien	83	BEL	6.86
2	3118	CHAMBERRY Muaka	89	ULB	6.86
3	2126	DECLOEDT Domien	85	KUL	6.99
4	1707	NTI Antony	92	EHB	7.02
5	9947	SESAY Adel	90	NED	7.06
6	2123	VRANKEN Andreas	05	KUL	7.08
7	2593	LINS Sebastien	92	HELV	7.16
8	2963	BEN AYED ZIAD	89	BEL	7.93

400 meter Sen V Time :20:48

Heat:1

1	1939	DUQUESNE Jeanne	94	HELH	62.68
2	106	MICHELIS Hege	96	BEL	62.76
3	316	MAUEL Anna Lena	96	BEL	63.66
4	940	BEDDELEEM Ilke	94	ARTE	67.01
5	1837	CEPHALE Fanny	92	HEG	71.35

400 meter Sen V Time :20:48

Heat:2

1	1164	MEERT Cynthia	89	VUB	60.95
2	1919	BODEUX Olivia	92	UL	62.02
3	1239	CRABBE Carolien	92	KUL	62.88
4	359	DE PRYCK Marlies	95	ARTE	63.33
5	163	VANBESIEN Flavie	95	KUL	64.15

400 meter Sen V Time :20:48

Heat:3

1	1069	VANFLETEREN Riet	91	KUL	57.84
2	1545	RAES Jessie	90	BEL	57.95
3	2007	GILLET Delphine	05	BEL	61.01
4	2066	LEPRINCE Audrey	94	UCL	61.10
5	254	HERMANS Ine	95	TMK	61.61

400 meter Sen V Time :20:48

Heat:4

1	9900	DE WITTE Lisanne	92	NED	53.30
2	9978	DOPHEIDE Marit	90	NED	54.29
3	339	NAGELS Rani	95	APHA	55.15
4	9911	VAN DER LIJCKE Esther	89	NED	55.86
5	1956	DE TEMMERMAN Gaelle	94	APHA	56.79

400 meter Sen Men Time :21:02

Heat:1

1	639	DELVOYE Pierre	96	BEL	54.77
2	2970	DUEZ Mathieu	91	HELV	55.36
3	788	JULIEN Martin	95	HELH	55.48
4	4775	NYSTEN Valere	94	UCL	55.81
5	4850	DUFOUR Bart	74	UH	57.76
6	9962	PARAMIO Jeremy	93	ULB	62.62

400 meter Sen Men Time :21:02

Heat:2

1	432	SENDEN Udo	95	UH	53.72
2	448	RADEMAKERS Guillaume	96	BEL	53.96
3	4620	VIERENDEELS Jan	68	UGEN	54.23

400 meter Sen Men Time :21:02

Heat:3

1	603	BODART Antoine	96	BEL	52.81
2	2646	FORMULE Thibaut	86	BEL	53.15
3	3014	LORENZI Samuel	94	UL	53.47
4	724	DUJARDIN Benoit	95	HEPH	55.11
5	787	DOLMANS Louis	96	BEL	55.19
6	392	PICAVET Tim	95	UGEN	57.54

400 meter Sen Men Time :21:02

Heat:4

1	2648	LUCION Alexandre	05	BEL	51.61
2	106	VAN NUFFEL Danny	95	ARTE	51.90
3	1741	REMMERY Jelle	94	UGEN	52.44

400 meter Sen Men Time :21:02

Heat:5

1	797	RAIWET Basile	96	BEL	50.95
2	153	VAN ACKER Manuel	95	HOWE	52.14
3	1884	VAN CAELENBERGHE Stefaan	94	UGEN	52.28
4	1917	SABBE Wouter	85	UGEN	52.52
5	126	BONTE Alexander	95	UGEN	55.00

400 meter Sen Men Time :21:02

Heat:6

1	9973	HEERINGS Joep	90	NED	49.98
2	51	DE LANGE Simon	95	UGEN	50.33
3	9964	NICOLA Gil	90	LUX	51.12
4	2634	PAULY Mickael	94	UL	51.43

400 meter Sen Men Time :21:02

Heat:7

1	9932	VAN DEN BERGH Olaf	94	NED	48.88
2	2815	HEYMANS Samuel	89	EPH	50.33
3	2699	REGINSTER Michel	93	UL	51.53

400 meter Sen Men Time :21:02

Heat:8

1	9909	VAN DER SCHAAF Stef	92	NED	50.50
2	3054	TATON Hugues	05	BEL	50.91
3	2600	JAMLI Tarik	86	BEL	51.02
4	2963	BEN AYED ZIAD	89	BEL	54.36

60 meter FINALE Sen V Time :21:09

Heat:1

1	9949	SAMUEL Jamile	92	NED	7.37
2	9975	FARIAS Bruna	92		7.49
3	1248	RUTJENS Sarah	92	UGEN	7.59
4	1157	VANHAEN Shana	93	KHLI	7.75
5	1350	DAELEMANS Sofie	91	UGEN	7.86
6	9968	KROONENBURG Nicole	89	NED	7.89
7	1357	DE GEEST Lize	91	UGEN	7.94

60 meter FINALE Sen Men Time :21:14

Heat:1

1	3118	CHAMBERRY Muaka	89	ULB	6.87
2	9947	SESAY Adel	90	NED	6.87
3	3105	BROOHAERTS Damien	83	BEL	6.90
4	2126	DECLOEDT Domien	85	KUL	6.97
5	1707	NTI Antony	92	EHB	7.01
6	2123	VRANKEN Andreas	05	KUL	7.03
7	1548	HUWEL Klaas	91	HOGE	7.15

800 meter Sen V Time :21:25

Heat:1

1	1215	GROFFEN Vicky	94	UA	2:33.67
2	253	VERMEULEN Ilke	96	BEL	2:35.08
3	1932	FORTHOMME Marjorie	05	HEPL	2:35.51
4	1132	DE VLIEGER Charlotte	93	UGEN	2:35.64
5	168	VAN HOVE Joke	05	UGEN	2:41.91
6	1425	DE VOS Kim	91		2:42.11
7	401	DEFEYTER Ine	95	KHVI	2:43.60
8	516	PONLOT Florine	95	FUND	2:43.75
9	1126	VAN CAMPENHOUT Sanne	93	UGEN	3:11.22
10	9992	CORNEZ Aurelie	92	HELH	3:16.49

800 meter Sen V Time :21:25

Heat:2

1	1029	ROSSAERT Mireille	90	UGEN	2:14.55
2	9986	DE VISSER Marijke	93	NED	2:14.69
3	9845	VOORRIPS Suzanne	93	NED	2:16.32
4	1058	PARDAENS Hanne	94	KUL	2:20.62
5	52	HEMELSOET Lara	96	BEL	2:22.26
6	84	VANDENLINDENLOOF Margot	96	BEL	2:23.53
7	127	DEVILLE Annelies	96	BEL	2:28.07
8	3872	CARDENAS Janet	73	ULB	2:29.39

800 meter Sen Men Time :21:38

Heat:1

1	181	STEVENS Wouter	05	BEL	2:03.65
2	1754	VERMEULEN Jelle	94	APHA	2:03.78
3	431	VANDELOO Dries	96	BEL	2:07.79
4	9997	AAFJES Joel	98	NED	2:07.95
5	1762	HEYNDELS Ewoud	87	UGEN	2:09.76

800 meter Sen Men Time :21:38

Heat:2

1	2162	VANHOUCKE Yngwie	93	KATH	2:02.70
2	278	GIEDTS Sam	05	GROE	2:04.54
3	258	HIELE Robin	95	UA	2:04.63
4	732	BUEN ABAD Timothe	95	FUSL	2:05.86
5	1001	VAN DER BURGT Thijs	94	HOGE	2:06.42
6	1703	PEETERS Olivier	91	UA	2:17.20

800 meter Sen Men Time :21:38

Heat:3

1	2597	KEBRON Quentin	92	HEPL	1:57.02
2	9963	NIEUWENHUIZEN Ralf	94	NED	1:58.20
3	1972	SANCTORUM Mathias	93	KHBO	2:00.57
4	2211	MORDIJCK Jeroen	90	KUL	2:03.82
5	1349	VER CRUYSSSE Anthony	92	ARTE	2:04.43

200 meter Sen V Time :21:54

Heat:1

1	259	TESSENS Helena	95	VUB	27.12
2	2463	VAN DAMME Petra	78	UGEN	28.52
3	1029	ROSSAERT Mireille	90	UGEN	28.72
4	1071	DEVILLE Sofie	94	HOGE	29.46
5	411	VAN POEL Esther	95	UGEN	29.51

200 meter Sen V Time :21:54

Heat:2

1	1830	LINS Noemie	94	HEG	27.78
2	17	LAMMENS Shari	96	BEL	27.79
3	378	BIEBUYCK Mona	96	BEL	28.30
4	352	DE LA MANE Marie	95	ARTE	28.33
5	190	CERPENTIER Mieke	95	UGEN	28.79
6	933	RYCKEBOER Eva	86	UGEN	29.15

200 meter Sen V Time :21:54

Heat:3

1	1091	DUPONT Louise	94	KATH	26.91
2	1355	CLAES Jente	92	KDG	27.32
3	261	DE MULDER Paulien	95	UGEN	27.44
4	1976	HEMROULLE Pascaline	92	HEPL	27.85
5	957	DE LAET Eva	93	UH	27.99
6	3045	FEIPEL Veronique	05	BEL	28.94

200 meter Sen V Time :21:54

Heat:4

1	1939	DUQUESNE Jeanne	94	HELH	26.54
2	1022	GROENEN Martine	94	UH	26.58
3	204	RUTSAERT Regine	95	APHA	27.82

200 meter Sen V Time :21:54

Heat:5

1	1461	LEMMENS Karolien	89	KUL	26.19
2	136	DEROLEZ Marie	95	APHA	26.50
3	301	BOGAERT Annelies	95	KAHO	27.10
4	1135	EYSACKERS Elien	94	BEL	27.39

200 meter Sen V Time :21:54

Heat:6

1	34	HUGAERTS Ine	95	UA	25.12
2	1619	TRUSSART Veronique	92	UCL	25.63
3	51	BELLEMANS Inge	95	KUL	25.93
4	9950	ROYBIER Maud	93	HEPL	31.12

200 meter Sen V Time :21:54

Heat:7

1	1376	GRILLET Justien	05	UGEN	24.06
2	1248	RUTJENS Sarah	92	UGEN	24.21
3	339	NAGELS Rani	95	APHA	24.84
4	9834	LOBO Miquella	94	NED	26.00

200 meter Sen Men Time :22:29

Heat:1

1	2925	BRABANT Jonathan	93	ULB	24.26
2	276	PIETERS Sven	95	BEL	25.73
3	9979	DONDJOU FOUELEFACK Charli	82	UMON	25.74
4	4717	DESCHAMPS Frederick	72	BEL	26.02

200 meter Sen Men Time :22:29

Heat:2

1	9915	VAN DER BRUGGEN Arvid	89	NED	23.98
2	3081	DE RIDDER Frederic	05	HELB	24.05
3	1549	GHYSELINCK Ben	91	UGEN	24.06
4	2970	DUEZ Mathieu	91	HELV	24.98
	9989	DAUBERCY Nicolas	94	ULB	DIS

200 meter Sen Men Time :22:29

Heat:3

1	33	JANSSENS Kamiel	96	BEL	23.81
2	99	VAN REETH Vincent	96	BEL	24.00
3	1152	BELLEMANS Koen	93	KUL	24.47
4	1799	VANNESTE Bavo	94	KHVI	24.58
	2179	D'HAEMER Laurenz	88	BEL	DNF

200 meter Sen Men Time :22:29

Heat:4

1	1337	DHAEZE Bregt	94	APHA	23.33
2	1814	MAES Gerben	94	HUB	23.51
3	1198	HOOYBERGHS Jens	93	KUL	23.85
4	1033	ANNAERT Wouter	94	KUL	24.49
5	2735	LE MEN Benoit	93	UCL	24.52

200 meter Sen Men Time :22:29

Heat:5

1	222	VAN HAUWERMEIREN Jasper	96	BEL	23.35
2	1468	DEFLEM Kenny	05	KUL	23.42

3 3106 DIALLO Oumar 94 HELB 24.10

200 meter Sen Men Time :22:29

Heat:6

1 421 DULLERS Jan 95 KHLI 22.69
2 9988 DE GROOT Dennis 83 NED 23.80
1035 MOTMANS Glenn 94 TMK DNF

200 meter Sen Men Time :22:29

Heat:7

1 1548 HUWEL Klaas 91 HOGE 22.23
2 1037 VRIJSEN Vincent 89 KUL 22.56
3 2927 THOMAS Olivier 94 UCL 22.91
4 183 DE MEULEMEESTER Alan 95 UGEN 23.50

200 meter Sen Men Time :22:29

Heat:8

1 2025 CALLUY Dylan 94 UA 23.02
2 2854 DATOUSSAID Mehdi 90 ULB 23.32
123 HENRY Laurent 95 APHA DNS
2123 VRANKEN Andreas 05 KUL DNF

200 meter Sen Men Time :22:29

Heat:9

1 2593 LINS Sebastien 92 HELV 22.35
2 9999 DUQUESNE Jean Philippe 91 HESP 22.77
3 980 PIETERS Giovanni 94 UGEN 22.86
4 2750 GOFFAUX Simon 89 UCL 23.16

200 meter Sen Men Time :22:29

Heat:10

1 3118 CHAMBERRY Muaka 89 ULB 21.93
2 9833 DESTATTE Arnaud 05 BEL 21.95
3 2929 DARQUENNES Raphael 95 UCL 23.12
2126 DECLOEDT Domien 85 KUL DNS

4 x 200 meter Sen V Time :22:44

Heat:1

1 SGOLA 1:54.12
859 JANSSENS Marijne 93 KUL
858 VERMERSCH Skrolan 92 APHA
856 IVO Kaat 00
867 JANSSENS Karlijn 91 UGEN
2 HEPL 1:59.52
9950 ROYBIER Maud 93
1932 FORTHOMME Marjorie 05
9991 CORRE Morgane 94
1976 HEMROULLE Pascaline 92
3 UMON 2:08.89
9980 D'HEYGERE Sarah 92
2040 BRUYERE Celine 92
9929 MONTIRONI Pauline 00
9933 HALLET Perrine 00

4 x 200 meter Sen Men Time :22:48

Heat:1

1				ULB	1:34.51
	2944	KEITA Franck			
	2671	LORIS Lionel	91		
	2854	DATOUSSAID Mehdi	90		
	3118	CHAMBERRY Muaka	89		
2				UCL	1:35.54
	2735	LE MEN Benoit	93		
	2666	NIJSTEN Valere	00		
	2927	THOMAS Olivier	94		
	2750	GOFFAUX Simon	89		
3				KHVI	1:36.24
	9919	VAN BELLEGHEM Wout			
	9918	COLPAERT Michiel	00		
	9990	CRUYT Gert	93		
	9890	VANDAELE Stein	92		
4				KUL	1:39.31
	1880	DAELEMANS Robin	92		
	1033	ANNAERT Wouter	94		
	2255	POPPELMONDE Dries	94		
	18	VERLINDEN Jasper	95		
5				HESP	1:39.55
	9999	DUQUESNE Jean Philippe	91		
	9839	DE LONGUEVILLE Benjamin	00		
	9792	LEMAIRE Florian	00		
	2679	MARBAIX Loic	92		

driekamp Sen V Time :20:37

Heat:1

1	1412	DE WAEL Els	90	UGEN	2470
2	605	LAURANT Chloe	95	UL	2155
3	74	HOOYBERGHS Elien	95	TMK	1979
4	1207	UMANS Kirsten	93	APHA	1748
5	285	TECK Lisa	95	HOGES	1270

60 meter KAMP Sen V Time :19:32

Heat:1

1	1412	DE WAEL Els	90	UGEN	7.86	892 P
2	605	LAURANT Chloe	95	UL	8.03	839 P
3	74	HOOYBERGHS Elien	95	TMK	8.31	755 P
4	1207	UMANS Kirsten	93	APHA	8.43	721 P
5	285	TECK Lisa	95	HOGES	9.39	470 P

kogel 3 KAMP 4,000kg Sen V Time :20:06

1	1412	DE WAEL Els	90	UGEN	12.65	704 P
2	74	HOOYBERGHS Elien	95	TMK	10.75	579 P
3	1207	UMANS Kirsten	93	APHA	10.56	566 P
4	605	LAURANT Chloe	95	UL	10.51	563 P
5	285	TECK Lisa	95	HOGES	9.11	471 P

ver 3 KAMP Sen V Time :18:17

1	1412	DE WAEL Els	90	UGEN	6.08	874 P
2	605	LAURANT Chloe	95	UL	5.68	753 P
3	74	HOOYBERGHS Elien	95	TMK	5.31	645 P
4	1207	UMANS Kirsten	93	APHA	4.63	461 P
5	285	TECK Lisa	95	HOGES	4.09	329 P

verspringen Sen V Time :19:08

1	9976	DWOMOH Gabriella	94	NED	5.78
2	1286	DE RUYCK Hanne	91	BEL	5.54
3	622	FLEURY Alice	95	UCL	5.52
4	1195	HEIJNDRIKX Ines	93	UGEN	5.29
5	1382	VAN LEUVEN Wendy	86	UA	5.21
6	254	HERMANS Ine	95	TMK	5.21
7	1966	CHEVALIER Alicia	93	UCL	5.11
8	268	LAMBRECHTS Jana	95	ARTE	5.00
9	543	GUISSE Saliyya	96	BEL	4.95
10	3045	FEIPEL Veronique	05	BEL	4.92
11	245	PAULISSEN Nel	95	BEL	4.92
12	261	DE MULDER Paulien	95	UGEN	4.86
13	1830	LINS Noemie	94	HEG	4.84
14	9940	SWANENBERG Joyce	94	NED	4.80
15	1976	HEMROULLE Pascaline	92	HEPL	4.55
16	956	VERSMISSEN Jolein	92	UH	4.48
17	1477	DE CEULAER Stephanie	94	APHA	4.48

polstokspringen Sen Men Time :19:58

1	2929	DARQUENNES Raphael	95	UCL	4.90
2	9872	DE WATER Timo	91	NED	4.70
3	1648	SAMANIUK Joseph	84	KUL	4.70
4	2351	DE MEYER Jonas	84	BEL	4.60
5	1898	VAN HAUWERMEIREN Kevin	92	KAHO	4.30
6	400	LEYS Mathias	96	BEL	4.20
7	2017	VANHOVE Dennis	92	KUL	4.10
8	22	BIENENS Michiel	96	BEL	4.10
9	2838	VAN WEYENBERG Alexis	91	UCL	4.10
10	3006	VAN DEN BEDEM Miguel	84	VUB	4.00
11	7005	JIDOVTSJEFF Boris	05	UL	3.80
	9857	VOS Ingmar	86	NED	NM
	1	BROEDERS Ben	95	KUL	NM

driekamp Sen Men Time :21:30

1	9967	LAM DaniÂl	94	NED	2159
2	2277	STAESSEN Rinus	92	UGEN	2034
3	2896	MAMMERICKX Yannick	93	UCL	1999
4	2089	BOGAERTS Jonas	94	UGEN	1996
5	1494	ANNYS Nicolas	94	KUL	1881
6	1185	D'OOSTERLINCK Lander	90	BEL	1874
7	2165	VANWYNSBERGHE Frederik	82	BEL	1768
8	1209	VERSMISSEN Bart	87	BEL	1672
9	9990	CRUYT Gert	93	KHVI	1443

60 meter 3 KAMP Sen Men Time :19:57

1	1185	D'OOSTERLINCK Lander	90	BEL	7.27	789 P
2	1494	ANNYS Nicolas	94	KUL	7.48	719 P
3	1209	VERSMISSEN Bart	87	BEL	7.54	700 P
4	9990	CRUYT Gert	93	KHVI	7.87	598 P

60 meter 3 KAMP Sen Men Time :19:57

1	9967	LAM DaniÂl	94	NED	7.28	785 P
2	2277	STAESSEN Rinus	92	UGEN	7.33	769 P
3	2089	BOGAERTS Jonas	94	UGEN	7.39	749 P
4	2896	MAMMERICKX Yannick	93	UCL	7.58	687 P

5	2165	VANWYNSBERGHE Frederik	82	BEL	7.66	662 P
ver	KAMP	Sen Men Time :21:31				
1	9967	LAM DaniÂl	94	NED	6.88	785 P
2	1494	ANNYS Nicolas	94	KUL	6.45	686 P
3	2896	MAMMERICKX Yannick	93	UCL	6.45	686 P
4	1185	D'OOSTERLINCK Lander	90	BEL	6.37	668 P
5	2089	BOGAERTS Jonas	94	UGEN	6.27	646 P
6	2277	STAESSEN Rinus	92	UGEN	6.14	617 P
7	1209	VERSMISSEN Bart	87	BEL	6.10	608 P
8	2165	VANWYNSBERGHE Frederik	82	BEL	5.79	542 P
9	9990	CRUYT Gert	93	KHVI	5.18	417 P

kogel 3	KAMP	7,260kg Sen Men Time :18:16				
1	2277	STAESSEN Rinus	92	UGEN	12.69	648 P
2	2896	MAMMERICKX Yannick	93	UCL	12.33	626 P
3	2089	BOGAERTS Jonas	94	UGEN	11.91	601 P
4	9967	LAM DaniÂl	94	NED	11.71	589 P
5	2165	VANWYNSBERGHE Frederik	82	BEL	11.30	564 P
6	1494	ANNYS Nicolas	94	KUL	9.84	476 P
7	9990	CRUYT Gert	93	KHVI	9.03	428 P
8	1185	D'OOSTERLINCK Lander	90	BEL	8.85	417 P
9	1209	VERSMISSEN Bart	87	BEL	7.96	364 P

kogelstoten	7,260kg	Sen Men Time :19:13				
1	1265	DENISSEN Jelle	05	KUL	15.02	
2	1820	VAN CAMPENHOUT Jannick	91	UGEN	14.59	
3	2171	VAN CAMPENHOUT Jordi	05	UA	14.19	
4	1198	HOOYBERGHS Jens	93	KUL	13.12	
5	1886	NYS Gerald	94	UGEN	12.58	
6	108	VAN WAES Brecht	95	BEL	12.24	
7	3103	NAMURIOS Bertrand	05	UL	11.38	
8	1394	VAN NEROM Jo	94	VUB	11.25	
9	2776	DEPOORTER Youri	05	ULB	10.69	
10	2134	DEJONCKHEERE Florian	94	UGEN	10.55	
	1930	FRIJTERS Pieter	90	KUL	NM	

hoogspringen	Sen V Time :19:24					
1	1408	DE PRIJCK Karen	93	KDG	1.65	
2	323	BORGHIS Jolien	95	APHA	1.65	
3	9913	ZWARTKRUIS Reinhilde	NED	1.60		
4	1190	DE VOGELAER Sarah	89	KUL	1.60	
5	9903	VAN LANDEGHEM Lydie	92	ULB	1.60	
6	17	LAMMENS Shari	96	BEL	1.55	
7	1605	VAN HOUTVEN Katrien	93	HUB	1.55	
8	9991	CORRE Morgane	94	HEPL	1.50	
	1480	VAN DEN BROECK Leen	92	HOGE	NM	

hinkstapspringen	Sen Men Time :20:00					
1	3026	KAPATA Leopold	92	BEL	14.80	
2	2679	MARBAIX Loic	92	HESP	14.09	
3	2160	DE LEENHEER Matthias	91	UGEN	13.63	
4	9995	BLANGE Joey	91	NED	12.83	
5	2014	DE HERDT Gorik	95	APHA	12.45	
6	823	DEPRE Gabriel	95	UCL	11.68	
7	46	PAUSENBERGER Yves	95	BEL	11.66	

hoogspringen Sen Men Time :21:52

1	2579	MAKENA Lois	93	BEL	2.10
2	9865	VERHEIJDE Hans	90	NED	1.93
3	2224	PEETERS Arne	90	KUL	1.93
4	2255	POPPELMONDE Dries	94	KUL	1.90
4	1172	PARMENTIER Thomas	92	UGEN	1.90
6	2208	DE PREKEL Laurenz	94	KDG	1.85
7	9849	VAN MEEL Roy	90	NED	1.85
8	1751	JACOBS Brett	94	UH	1.80
8	1880	DAELEMANS Robin	92	KUL	1.80
8	1033	ANNAERT Wouter	94	KUL	1.80
11	18	VERLINDEN Jasper	95	KUL	1.80
12	3027	VAN STEENBERGE Andr™	94	HELM	1.75
13	878	PATERNOSTRE Hugo	96	BEL	1.70
	9857	VOS Ingmar	86	NED	NM
	483	VERMEULEN David	96	BEL	NM
	726	HANS Bastien	05	UL	NM
	2919	ELSEN Daan	94	VUB	NM

hinkstapspringen Sen V Time :20:56

1	1432	MIEVIS Stefie	93	UGEN	12.04
2	1993	LOUREIRO Elsa	92	HELM	11.81
3	507	DUVIVIER Karine	95	UCL	11.47
4	300	HOFMAN Jorien	96	APHA	10.72
5	957	DE LAET Eva	93	UH	10.65
6	956	VERSMISSEN Jolein	92	UH	10.14
7	858	VERMERSCH Skrolan	92	APHA	9.91
	1422	NYS Inge	90	UGEN	NM

polstokspringen Sen V Time :22:08

1	363	DE VOCHT Elien	95	TMM	3.80
2	1483	VERCAUTEREN Anouk	92	BEL	3.70
2	706	QUIRIN Margaux	95	KUL	3.70
4	1630	DHONT Steffi	92	UGEN	3.60
5	1562	LAING Brittany	94	KUL	3.60
6	1202	DE ROECK Nelle	05	ARTE	3.40
7	1526	ANDRIES Nathalie	91	KUL	3.30
8	1524	ANDRIES Lien	93	KHLE	3.30
9	1579	QUIRIN Laura	90	UGEN	3.30
10	631	CALICIS Chloe	95	UCL	3.00
11	1486	VANDEKERCKHOVE Kim	92	UGEN	2.80

kogelstoten 4,000kg Sen V Time :21:19

1	1444	BOUMKWO Jolien	93	UGEN	14.85
2	236	DE PAUW Yoika	95	UGEN	13.43
3	2050	MASTAIL Catherine	93	BEL	12.65
4	1318	ROEGIERS Sarah	05	KHVI	12.36
5	289	LYSSENS Katelijne	95	KHLE	12.29
6	1111	VAN NEROM Nele	92	VUB	11.95
7	989	VAN NIEUWENHUYSE ELS	RAM	10.83	
8	1000	LINDEMANS Marjolein	94	HOGHE	10.57
9	1613	LAGROU Anke	92	KUL	10.15
10	1236	MARYNISSEN Elies	94	KUL	10.03
11	311	VAN NIEUWENHOVE Jana	95	KAHO	9.76
12	1208	VAN DE VOORDE Freya	92	KDG	8.94

13	9994	CAVADINI Caroline	90	ULB	8.76
14	9903	VAN LANDEGHEM Lydie	92	ULB	8.52
15	1244	ACKERMAN Aurelie	89	BEL	8.38
16	1867	GUISSE Shaena	94	ULB	8.00
17	9991	CORRE Morgane	94	HEPL	7.31
18	3045	FEIPEL Veronique	05	BEL	7.04
	406	VAN DEN BRULLE Kato	96	BEL	NM
	1422	NYS Inge	90	UGEN	NM
	1269	DE VLEESCHAUWER Elke	90	UGEN	NM

verspringen Sen Men Time :22:53

1	1278	BROOHAERTS Mathias	94	UA	7.66
2	2151	NOLF Cedric	89	UGEN	7.55
3	9969	KRANENDONK Marius	88	NED	7.54
4	2892	STEMPNICK Nicolas	89	BEL	7.53
5	1162	DE DECKER Bjorn	89	BEL	7.25
6	1973	SANCTORUM Maxim	93	KHBO	7.01
7	2168	HANJOUL Beno�t	05	KUL	6.59
8	2671	LORIS Lionel	91	ULB	6.54
9	2864	MAHIEU Sebastien	92	HEH	6.48
10	2826	CALUWE Arnaud	05	HUB	6.34
11	451	THIBAU Arno	95	UGEN	6.32
12	2679	MARBAIX Loic	92	HESP	6.20
13	1868	VAN DEN BERGHE Ruben	89	ARTE	5.90
14	9977	DOS SANTOS Sacha	94	HELB	5.76
15	2014	DE HERDT Gorik	95	APHA	5.75
16	717	BARTHELEMY Thomas	05	BEL	5.36
	324	VAN DE STEEN Matthias	95	UGEN	NM
	9943	STIEGLIS Yoeri	90	NED	NM
	9948	SCHUTJES Sander	88	NED	NM
	9960	PENGEL Jonathan	85	NED	NM
	3103	NAMURIOS Bertrand	05	UL	NM
	3095	GRAILET Francois	94	UL	NM

Jeudi 1er mai 2014

Championnat Enseignement Supérieur Compétition OPEN

INFORMATIONS GENERALES :

- * **HORAIRE** : accès au stade dès 12h.
Début des compétitions 13h30.
- * **LIEU** : RFCL Naimette Xhovémont,
Boulevard Philippet 83, 4000 Liège.
- * **INFOS** : <http://www.aseus.be/championnats/details/3444>.
Chronométrage électronique.



INSCRIPTIONS :

En ligne via le lien : <http://www.aseus.be/formulaire/2227>
Open : paiement sur place 5 €

Clôture le lundi 28/04/2014, 16h.

Le responsable sport de ton institution recevra une confirmation de ton inscription par mail.

Inscris-toi sans attendre grâce à ton smartphone et ce QR-CODE !



Résultats du Championnat FSUB d' Athlétisme outdoor

RFCL Naimette - Xhovémont

Jeudi 1 mai 2014



Courses

400m haies 0,762m TC Dames Heure de l'annonce officielle:14:52
Serie:1

1	163	VANBESIEN FLAVIE	64.36s	Jun	95	KUL
2	1212	Van Eecke Louise	67.58s	Sen	92	LUCA
3	1697	DEBERSAQUES SARAH	74.13s	Sen	94	ARTE
4	1837	CEPHALE FANNY	78.46s	Sen	92	WS
5	9911	CORRE Morgane	80.47s	Sen	00	HEPL

400m haies 0,762m TC Dames Heure de l'annonce officielle:14:52
Serie:2

1	1015	CLAES HANNE	57.30s	Sen	91	KUL
2	1619	TRUSSARD Véronique	61.53s	Sen	92	UCL
3	1662	Duinslaeger Eva	61.54s	Sen	88	KUL
4	1432	MIEVIS STEFIE	62.77s	Sen	93	UGe
5	51	BELLEMANS INGE	63.30s	Jun	95	KUL
6	2066	LEPRINCE AUDREY	63.52s	Sen	94	UCL

400m haies 0,914m TC Hommes Heure de l'annonce officielle:14:52
Serie:1

1	1647	RUMMENS TIM	51.08s	Sen	87	KUL
2	1382	Heggen Erik	51.88s	Sen	92	KUL
3	9928	PEETERS Dries	55.53s	Sen	91	KUL
4	2199	Ulens Thijs	55.84s	Sen	92	VUB
	9904	BAYARD Jean-Christophe	DNF	Mas	78	DAMP

400 mètres TC Dames Heure de l'annonce officielle:15:41
Serie:1

1	1553	TAHON CHARLOTTE	56.07s	Sen	92	KUL
2	1956	DE TEMMERMAN GAELLE	57.00s	Sen	94	HESp
3	504	MAHEUX NATHALIE	58.19s	Jun	95	HEPL
4	9939	KRUMLOVSKY Tamara	58.29s		97	Open
5	1919	BODEUX OLIVIA	60.06s	Sen	92	Ulg
6	611	COOSEMANS ELISE	60.46s	Jun	96	SPA
7	1875	BEUGNIES HELENE	62.95s	Sen	94	HELH
8	2027	VERNIMMEN MARIE	64.65s	Sen	92	HELH

400 mètres TC Hommes Heure de l'annonce officielle:15:41
Serie:1

1	2881	Martin Edwin	54.19s	Sen	92	HEPH
2	3252	VANSTRAELEN THIERRY	54.73s	Sco	97	SER
3	639	Delvoye Pierre	55.19s	Jun	96	RFCL
4	893	BOA MICHAEL	55.45s	Jun	95	RESC
5	1794	CHASSEUR Adrien	69.59s		00	FAC
	9936	DORMAL Guillaume	DNF		00	OPEN

400 mètres TC Hommes Heure de l'annonce officielle:15:41
Serie:2

1	2728	ANTHIERENS Jeff	53.10s	Sen	94	ICHE
2	1152	BELLEMANS Koen	53.29s	Sen	93	KUL
3	3144	HAUTRIVE CEDRIC	53.72s	Sen	89	UCL
4	2963	BEN AYED ZIAD	53.75s	Sen	89	ULB
5	2925	Brabant Jonathan	53.77s	Sen	93	ULB
6	9944	BASTIN Vincent	55.10s		00	HF

400 mètres TC Hommes Heure de l'annonce officielle:15:41
Serie:3

1	797	Raiwet Basile	50.41s	Jun	96	SMAC
2	2600	Jamli Tarich	51.01s	Sen	86	WS
3	2039	DE MOL AIKO	51.18s	Sen	88	HUB
4	3084	MAINGAIN FRANCOIS	51.82s	Sen	89	WS
5	106	VAN NUFFEL DANNY	51.87s	Jun	95	ARTE
6	603	BODART ANTOINE	52.16s	Jun	96	SMAC

100 mètres TC Dames Heure de l'annonce officielle:15:45
Serie:1 Vent : -0.3m/s

1	688	LEPRINCE LAURA	11.91s	Jun	95	Schu
2	1157	Vanhaen Shana	12.27s	Sen	93	KHLi
3	9930	BERENDSE Silke	12.80s	Sco	98	OPEN
4	1991	HUYNEN CELINE	13.41s	Sen	88	Ulg
5	641	FRANSQUET KADIDJA	13.44s	Jun	96	SER
6	1976	HEMROULLE PASCALINE	13.48s	Sen	92	HEPL
7	9907	DELSAUX Claudine	14.56s	Sen	93	HELM

100 mètres TC Dames Heure de l'annonce officielle:15:45
Serie:2 Vent : -1.9m/s

1	1996	DIWANI ALISON	12.19s	Sen	93	HELB
2	1914	THIAM NAFISSATOU	12.31s	Sen	94	Ulg
3	9945	BALTES Debbie	12.33s	Jun	96	OPEN
4	575	BRAHY MEGANE	13.06s	Jun	95	SMAC
5	509	Dewilde Manon	13.08s	Jun	96	CABW
6	591	CORNET SARAH	13.57s	Jun	96	SER
7	640	KASSIANOFF SYLVIE	13.65s	Jun	96	RESC
8	2039	FRANCK AMELIE	15.99s	Sen	91	HERV

100 mètres TC Dames Heure de l'annonce officielle:15:45
Serie:3 Vent : 0.3m/s

1	1357	De Geest Lize	12.41s	Sen	91	UGen
2	1619	TRUSSARD Véronique	12.41s	Sen	92	UCL
3	4173	Fickers Marie	12.48s	Sco	97	LACE
4	1886	EGO CAROLINE	12.59s	Sen	86	UCL
5	677	BRIOLO JULIETTE	13.30s	Jun	96	CABW
6	4425	KITENGE ELYSABETH	13.56s	Sco	97	RFCL
7	712	Sauvage Pauline	13.92s	Jun	96	HUY
8	620	WATTEYNE MANON	14.08s	Jun	95	HESp

100 mètres TC Dames Heure de l'annonce officielle:15:45
Serie:4 Vent : -1.2m/s

1	379	MEHUYS ELISE	12.57s	Jun	95	KUL
2	9937	WIJCK Gabriella	12.79s	Sco	97	OPEN
3	2080	GASPAR CAROLE	12.99s	Sen	94	HELM
4	1975	FOUCART CLEMENCE	13.01s	Sen	88	UNam
5	1830	Lins Noémie	13.58s	Sen	94	RESC
6	1460	VAN DEN ABEELE LAURE	13.70s	Cad	00	ACLO
7	692	Sotiau Anaïs	14.20s	Jun	95	HERV
8	545	Simons Lina	14.41s	Jun	96	LACE

100 mètres TC Hommes Heure de l'annonce officielle:16:23
Serie:1 Vent : 0.7m/s

1	2950	LOUIS JEAN MARIE	10.79s	Sen	86	RFCL
2	2680	ANDRE DORIAN	11.20s	Sen	89	MOHA

3	2944	Keita Franck	11.23s	Sen	93	ULB
4	892	BADJI ASAMTI	11.51s	Jun	95	ULB
5	3362	Urbain Hugo	11.73s	Sco	97	CABW
6	2776	BIJNENS NIELS	11.87s	Sco	97	ATLA
7	759	DUZGUN MIKAIL	12.16s	Jun	96	RESC
8	2830	DESSY BENOIT	12.91s	Sen	87	HERV

100 mètres TC Hommes Heure de l'annonce officielle:16:23

Serie:2 Vent : 0.5m/s

1	3083	AMMAR KHODJA BRAHIM	11.01s	Sen	84	RESC
2	9927	PALAS Denasio	11.17s	Jun	95	OPEN
3	715	DREZE ANTHONY	11.71s	Jun	96	CABW
4	2789	Jonlet Corentin	11.72s	Sen	92	HEPL
5	934	OUEDRAOGO LEONARD	12.14s	Jun	95	RFCL
6	867	KALIBIONA RAPHAEL	12.53s	Jun	96	RESC
7	9936	DORMAL Guillaume	15.11s		00	OPEN
	3011	VANDEBEMDEN ROBIN	DNF	Sen	94	ULg

100 mètres TC Hommes Heure de l'annonce officielle:16:23

Serie:3 Vent : 1.1m/s

1	3118	MUAKA CHAMBERRY	10.74s	Sen	89	ULB
2	2815	HEYMANS SAMUEL	10.98s	Sen	89	EPHE
3	811	Brunin Clement	11.28s	Jun	96	MOHA
4	361	GEUSKENS WILLEM	11.39s	Jun	95	KUL
5	3081	DE RIDDER FREDERIC	11.68s	Sen	90	HEPL
6	897	LOUCOU YANN	12.17s	Jun	96	SER
7	636	HAZARD ADRIEN*	12.96s	Jun	96	HERV
	1880	DAELEMANS ROBIN	DNS	Sen	92	KUL

100 mètres TC Hommes Heure de l'annonce officielle:16:23

Serie:4 Vent : 0.3m/s

1	2740	BURON LOZANO*	11.06s	Sen	91	ULB
2	2123	VRANKEN ANDREAS	11.08s	Sen	93	KUL
3	829	DEGAVRE LIONEL	11.13s	Jun	95	HERV
4	3018	ENNAMIR MOHSSINE	11.58s	Sen	85	WS
5	663	ROELANDT MATHIEU	11.86s	Jun	96	ACLO
6	1684	LAFORT IARRE	12.10s	Sen	93	UGe
7	9935	LECUYER Jordan	12.73s	Sen	86	OPEN
	7156	Reyners Patrick	DNS	Mas	65	WACO

100 mètres TC Hommes Heure de l'annonce officielle:16:23

Serie:5 Vent : 0.8m/s

1	9940	GERALDO Festos	11.00s		88	Celt
2	3094	Kola Biasu Guelord*	11.07s	Sen	93	RFCL
3	2854	DATOUSSAID MEHDI	11.29s	Sen	90	ULB
4	2711	DETRY LIONEL	11.72s	Sen	94	CABW
5	895	PUKU TOKU CHRISTIAN	11.90s	Jun	96	RESC
6	9900	AZABIA Geoffrey	12.31s	Sen	91	HELM
	2881	Martin Edwin	DNS	Sen	92	HEPH

100 mètres TC Hommes Heure de l'annonce officielle:16:23

Serie:6 Vent : 1.0m/s

1	3012	Bah Mamadou Oury*	10.88s	Sen	88	SER
2	2671	LORIS LIONEL	10.98s	Sen	91	ULB
3	183	De Meulemeester Alan	11.11s	Jun	95	UGe
4	2750	GOFFAUX SIMON	11.23s	Sen	89	UCL

5	9908	DULIEU Thomas	12.09s	Sen	93	HELM
6	787	Dolmans Louis	12.19s	Jun	96	ACLO
7	3273	SERVILLE FLORIAN	13.22s	Sco	97	HERV

100 mètres TC Hommes Heure de l'annonce officielle:16:23
Serie:7 Vent : 0.9m/s

1	9918	HEIJNEN Noah	11.05s	Jun	95	OPEN
2	9921	ELABEIDI Jamiro	11.16s	Jun	96	OPEN
3	2167	HANJOUL DENIS	11.25s	Sen	91	KUL
4	2821	CRESPEIGNE ROMAIN	11.27s	Sen	92	HELH
5	9917	SCHMITZ Olivier	11.99s	Sen	90	ULB
6	3189	KEISER LOIC	12.24s	Sco	97	CABW

100 mètres TC Hommes Heure de l'annonce officielle:16:23
Serie:8 Vent : 0.6m/s

1	9925	BROER Rodrigo Willy	10.96s	Jun	00	OPEN
2	2593	LINS SEBASTIEN	11.24s	Sen	92	HELV
3	3159	MACAULAY ROBERT JUNIOR*	11.29s	Sen	90	EPHE
4	2824	VAN DEN BROECK EMILE	11.37s	Sen	94	HELV
5	3157	GIBELLA MASSIMO*	11.79s	Sen	94	RESC
6	486	Kalandula Fabiano	11.88s	Jun	96	SPVI
7	1868	VAN DEN BERGHE RUBEN	12.21s	Sen	89	ARTE
8	7159	Cabay Jean Louis	12.35s	Mas	65	WACO

100 mètres TC Hommes Heure de l'annonce officielle:16:23
Serie:9 Vent : 0.0m/s

1	9943	EVORA Lionel	11.40s	Jun	96	LUX
2	3098	HOOYBERGHS Jens	11.95s	Sen	93	KUL
3	7099	MERZOUG BRAHIM	12.25s	Mas	77	RESC
4	3176	MARTINESSE EMMANUEL	12.89s	Sen	88	FAC
5	3047	QUITTELIER JASON	14.75s	Sen	90	FAC

800 mètres TC Dames Heure de l'annonce officielle:16:59
Serie:1

1	9906	TONNEAU Sophie	2'18.77	Sen	94	HELV
2	522	HAYEZ LOUISE	2'33.40	Jun	96	WS
3	2013	NIZET ALICIA	2'37.81	Sen	93	HELM
4	590	DUMOULIN VICTORIA	2'40.46	Jun	95	HEPL
5	1932	FORTHOMME MARJORIE	2'42.89	Sen	94	HEPL

800 mètres TC Hommes Heure de l'annonce officielle:16:59
Serie:1

1	700	HINNEKENS SIMON	2'01.70	Jun	95	UCL
2	3169	BLACHERE ALEXANDRE	2'02.38	Sen	93	HELM
3	732	BUEN ABAD TIMOTHE	2'02.73	Jun	95	USLB
4	448	RADEMAKERS GUILLAUME	2'03.47	Jun	96	DCLA
5	2922	SAERENS ADRIEN	2'04.27	Sen	94	ULB
6	765	GUILICK ANTOINE	2'04.42	Jun	95	ULg
7	697	TAJAOUART HAMZA	2'08.32	Jun	95	RESC
8	2647	FORMULE AMAURY	2'08.45	Sen	86	ACLO
9	726	HANS BASTIEN	2'12.24	Jun	95	ULg
10	9902	VAN LAER	2'15.61	Sen	90	ULB
11	607	JOCKIN FRANCOIS	2'16.80	Jun	95	RFCL

800 mètres TC Hommes Heure de l'annonce officielle:16:59
Serie:2

1	206	BENSCHOP VIKTOR	1'55.56	Jun	95	ARTE
2	2914	Gillet Julien	1'55.89	Sen	93	UCL
3	2655	DELGUSTE MARTIN	1'56.08	Sen	91	ucl
4	9901	EON Benjamin	1'56.46	Sen	91	HEPH
5	2705	SCARNIET FRANCOIS	1'58.04	Sen	93	UCL
6	757	VAN DEN HOEKE ARTHUR	1'58.29	Jun	96	RESC
7	2162	Vanhoucke Yngwie	1'59.53	Sen	93	FLAC
8	2648	LUCION ALEXANDRE	2'00.58	Sen	90	ACLO
9	2646	FORMULE THIBAUT	2'00.88	Sen	86	ACLO
10	6638	DETHIER GAEL	2'04.21	Mas	77	SPA

100 mètres TC Dames Heure de l'annonce officielle:19:06
Serie:1 Vent : 0.0m/s

1	1886	EGO CAROLINE	12.58s	Sen	86	UCL
2	9930	BERENDSE Silke	12.65s	Sco	98	OPEN
3	2080	GASPAR CAROLE	12.73s	Sen	94	HELM
4	9937	WIJCK Gabriella	12.78s	Sco	97	OPEN
5	575	BRAHY MEGANE	12.82s	Jun	95	SMAC
6	1975	FOUCART CLEMENCE	13.03s	Sen	88	UNam
7	509	Dewilde Manon	13.12s	Jun	96	CABW
	379	MEHUYS ELISE	DNS	Jun	95	KUL

100 mètres TC Dames Heure de l'annonce officielle:19:06
Serie:2 Vent : 1.2m/s

1	688	LEPRINCE LAURA	11.77s	Jun	95	Schu
2	1996	DIWANI ALISON	11.97s	Sen	93	HELB
3	1157	Vanhaen Shana	12.24s	Sen	93	KHLi
4	1914	THIAM NAFISSATOU	12.33s	Sen	94	Ulg
5	1619	TRUSSARD Véronique	12.43s	Sen	92	UCL
6	4173	Fickers Marie	12.48s	Sco	97	LACE
7	9945	BALTES Debbie	12.50s	Jun	96	OPEN
8	1357	De Geest Lize	12.59s	Sen	91	UGen

100 mètres TC Hommes Heure de l'annonce officielle:17:10
Serie:1 Vent : 0.6m/s

1	2740	BURON LOZANO*	11.00s	Sen	91	ULB
2	2123	VRANKEN ANDREAS	11.01s	Sen	93	KUL
3	183	De Meulemeester Alan	11.05s	Jun	95	UGe
4	3094	Kola Biasu Guelord*	11.06s	Sen	93	RFCL
5	829	DEGAVRE LIONEL	11.09s	Jun	95	HERV
6	9927	PALAS Denisio	11.11s	Jun	95	OPEN
7	9921	ELABEIDI Jamiro	11.15s	Jun	96	OPEN
	9918	HEIJNEN Noah	DNS	Jun	95	OPEN

100 mètres TC Hommes Heure de l'annonce officielle:17:10
Serie:2 Vent : 0.6m/s

1	3118	MUAKA CHAMBERRY	10.72s	Sen	89	ULB
2	2950	LOUIS JEAN MARIE	10.80s	Sen	86	RFCL
3	9925	BROER Rodrigo Willy	10.84s	Jun	00	OPEN
4	2815	HEYMANS SAMUEL	10.92s	Sen	89	EPHE
5	9940	GERALDO Festos	10.96s		88	Celt
6	2671	LORIS LIONEL	10.98s	Sen	91	ULB
7	3083	AMMAR KHODJA BRAHIM	10.99s	Sen	84	RESC
8	3012	Bah Mamadou Oury*	11.04s	Sen	88	SER

1500 mètres TC Dames Heure de l'annonce officielle:17:57
Serie:1

1	1893	SAUSSEZ AMELIE	4'55.38	Sen	88	ACLO
2	560	VAN DEN ABEELE ELODIE	4'55.46	Jun	96	ACLO
3	250	VERBRUGGEN HANNA	5'03.67	Jun	95	KUL
4	501	TSHIASUMA JESSIE	5'16.73	Jun	96	RESC
5	516	PONLOT Florine	5'41.93	Jun	95	UNam
6	9913	ALEXANDER Catherine	6'13.95		93	HECH

1500 mètres TC Hommes Heure de l'annonce officielle:17:57
Serie:1

1	3093	Denays Pierre	4'00.09	Sen	89	USTA
2	1256	ROEYGENS Lodewijk	4'01.92	Sen	93	KUL
3	9912	BADANO Andrea	4'05.30	Sen	90	UCL
4	633	PETITJEAN SIMON	4'10.84	Jun	96	RESC
5	1349	Ver Cruysse Anthony	4'13.29	Sen	92	ARTE
6	1545	Vandeneede Jean-Baptiste	4'20.09	Sen	93	UGen
7	3229	BASTIEN FRANCOIS	4'20.50	Sen	88	WS
8	3122	MICHEL MAXIME	4'21.91	Sen	92	UCL
9	2698	MERTZ CHRISTOPHER	4'22.44	Sen	93	RFCL
10	2697	BOUZIDI DJAMEL	4'24.89	Sen	79	SER
11	719	KOHNEN RAPHAEL	4'36.14	Jun	96	RFCL
12	9949	POUMAY Pierre	4'38.27	Sen	94	WACO

100m haies 0,84m TC Dames Heure de l'annonce officielle:17:58
Serie:1 Vent : 0.7m/s

1	1975	FOUCART CLEMENCE	15.60s	Sen	88	UNam
2	1991	HUYNEN CELINE	16.32s	Sen	88	Ulg
3	2027	VERNIMMEN MARIE	16.97s	Sen	92	HELH
4	1966	CHEVALIER ALICIA	17.03s	Sen	93	UCL

100m haies 0,84m TC Dames Heure de l'annonce officielle:17:58
Serie:2 Vent : 1.3m/s

1	552	Van Cauwenberghe Siliane	13.93s	Jun	96	DS
2	236	DE PAUW YOIKA	14.57s	Jun	95	UGen
3	9942	RAUSCH Victoria	14.98s	Jun	96	OPEN
4	74	HOOYBERGHS ELIEN	15.18s	Jun	95	TMK
	688	LEPRINCE LAURA	DNS	Jun	95	Schu

110m haies 1,067m TC Hommes Heure de l'annonce officielle:17:59
Serie:1 Vent : 0.5m/s

1	2637	RUFFACQ QUENTIN	14.14s	Sen	89	DS
2	2167	HANJOUL DENIS	14.23s	Sen	91	KUL
3	2715	VERSTRAELEN THOMAS	15.30s	Sen	89	HF
4	1396	Seutin Rodric	15.77s	Sen	92	KUL
5	2750	GOFFAUX SIMON	16.16s	Sen	89	UCL
6	1880	DAELEMANS ROBIN	16.39s	Sen	92	KUL
	3035	Gets Florent	DNF	Sen	91	HEVi
	2821	CRESPEIGNE ROMAIN	DNS	Sen	92	HELH

200 mètres TC Dames Heure de l'annonce officielle:19:01
Serie:1 Vent : 1.2m/s

1	575	BRAHY MEGANE	26.01s	Jun	95	SMAC
2	509	Dewilde Manon	26.96s	Jun	96	CABW
3	640	KASSIANOFF SYLVIE	27.31s	Jun	96	RESC
4	591	CORNET SARAH	27.70s	Jun	96	SER

5	1920	DUMOULIN MATHILDE	28.79s	Sen	93	ULg
6	545	Simons Lina	28.88s	Jun	96	LACE
7	712	Sauvage Pauline	29.10s	Jun	96	HUY
8	1808	Pauly Aurore	29.85s	Sen	91	ULg

200 mètres TC Dames Heure de l'annonce officielle:19:01

Serie:2 Vent : 1.0m/s

1	157	CEYSSENS LINDE	26.30s	Jun	96	AVT
2	703	Badji Jalika	26.83s	Jun	96	RESC
3	4026	LEONARD SARAH	27.26s	Sco	97	FCHA
4	1976	HEMROULLE PASCALINE	27.58s	Sen	92	HEPL
5	1460	VAN DEN ABEELE LAURE	27.60s	Cad	00	ACLO
6	9922	PARIZKOVA Lada	27.63s	Sen	00	CZE
7	1817	Carlier Tiphaine	28.57s	Sen	93	UCL
	1830	Lins Noémie	DNS	Sen	94	RESC

200 mètres TC Dames Heure de l'annonce officielle:19:01

Serie:3 Vent : 0.6m/s

1	1956	DE TEMMERMAN GAELLE	25.35s	Sen	94	HESp
2	1524	ANDRIES LIEN	25.53s	Sen	93	KHL
3	1886	EGO CAROLINE	25.63s	Sen	86	UCL
4	2080	GASPAR CAROLE	26.22s	Sen	94	HELM
5	1939	DUQUESNE JEANNE	27.22s	Sen	94	HELH
6	654	KLAI ANISSA	27.22s	Jun	96	RESC
7	1998	WEERTS ELODIE	27.37s	Sen	91	ULg
	4173	Fickers Marie	DNS	Sco	97	LACE

200 mètres TC Hommes Heure de l'annonce officielle:19:01

Serie:1 Vent : 1.1m/s

1	3249	Yeboah Jeffrey	24.33s	Sen	93	RFCL
2	9917	SCHMITZ Olivier	24.52s	Sen	90	ULB
3	897	LOUCOU YANN	24.59s	Jun	96	SER
4	3189	KEISER LOIC	24.67s	Sco	97	CABW
5	867	KALIBIONA RAPHAEL	25.37s	Jun	96	RESC
6	636	HAZARD ADRIEN*	26.35s	Jun	96	HERV

200 mètres TC Hommes Heure de l'annonce officielle:19:01

Serie:2 Vent : 0.7m/s

1	2925	Brabant Jonathan	23.98s	Sen	93	ULB
2	3014	Lorenzi Samuel	24.07s	Sen	94	ULg
3	1684	LAFORT IARRE	24.09s	Sen	93	UGe
4	1868	VAN DEN BERGHE RUBEN	24.22s	Sen	89	ARTE
5	787	Dolmans Louis	24.64s	Jun	96	ACLO
6	9908	DULIEU Thomas	24.74s	Sen	93	HELM
7	759	DUZGUN MIKAIL	25.09s	Jun	96	RESC

200 mètres TC Hommes Heure de l'annonce officielle:19:01

Serie:3 Vent : 1.3m/s

1	2824	VAN DEN BROECK EMILE	22.61s	Sen	94	HELV
2	715	DREZE ANTHONY	23.39s	Jun	96	CABW
3	3362	Urbain Hugo	23.47s	Sco	97	CABW
4	663	ROELANDT MATHIEU	23.65s	Jun	96	ACLO
5	895	PUKU TOKU CHRISTIAN	23.81s	Jun	96	RESC
6	2963	BEN AYED ZIAD	25.18s	Sen	89	ULB
	2789	Jonlet Corentin	DNS	Sen	92	HEPL

200 mètres TC Hommes Heure de l'annonce officielle:19:01
Serie:4 Vent : 1.2m/s

1	2123	VRANKEN ANDREAS	21.95s	Sen	93	KUL
2	2025	Calluy Dylan	22.15s	Sen	94	UAnt
3	2944	Keita Franck	22.36s	Sen	93	ULB
4	124	Muermans Maxim	22.59s	Jun	96	ATLA
5	2680	ANDRE DORIAN	22.65s	Sen	89	MOHA
6	123	HENRY LAURENT	22.80s	Jun	95	ATLA
7	892	BADJI ASAMTI	22.90s	Jun	95	ULB
8	2854	DATOUSSAID MEHDI	22.99s	Sen	90	ULB

200 mètres TC Hommes Heure de l'annonce officielle:19:01
Serie:5 Vent : 1.3m/s

1	3118	MUAKA CHAMBERRY	21.60s	Sen	89	ULB
2	3083	AMMAR KHODJA BRAHIM	21.89s	Sen	84	RESC
3	2815	HEYMANS SAMUEL	22.01s	Sen	89	EPHE
4	2740	BURON LOZANO*	22.25s	Sen	91	ULB
5	9940	GERALDO Festos	22.52s		88	Celt
6	3018	ENNAMIR MOHSSINE	22.77s	Sen	85	WS
	2593	LINS SEBASTIEN	DNS	Sen	92	HELV
	2950	LOUIS JEAN MARIE	DNS	Sen	86	RFCL

5000 mètres Sen Hommes Heure de l'annonce officielle:19:43
Serie:1

1	1472	LAMMENS WOUTER	16'20.64		94	kul
2	774	OTTO BERNARD	16'24.36	Jun	95	hephc
3	2580	PIRAUX OLIVIER	16'32.94		90	CSDY
4	2553	Govaert Thomas	16'38.82		93	ugen
5	632	Tixhon Yorick	16'56.81	Jun	95	ucl
6	2978	Huberland Francois	17'01.47		93	ulb
7	2856	EVARD QUENTIN	17'15.65		94	RFCL
8	2903	Pirard Logan	17'24.12		92	ulg
9	2767	Vanderheyden Valentin	17'32.52		92	helm
10	1080	Chauliac Margot	18'59.47		93	UA
11	1074	HANSEN Véronique	19'24.82		80	Diek
12	1879	DE COCK FLORENCE	19'42.70		92	ucl
13	2655	DELGUSTE MARTIN	19'43.31		91	ucl

5000 mètres Sen Dames Heure de l'annonce officielle:19:43

1	1080	Chauliac Margot	18'59.47		93	UA
2	1074	HANSEN Véronique	19'24.82		80	Diek
3	1879	DE COCK FLORENCE	19'42.70		92	ucl

3000m steeple 0,914m TC Hommes Heure de l'annonce officielle:19:15
Serie:1

1	1649	DEJONCKHEERE DIMITRI	10'07.89	Sen	94	howe
2	682	RUSCART BENOIT	10'17.11	Jun	95	HEPH
3	2917	NICODEME THIBAUT	11'05.01	Sen	92	ulg
	9980	ROLAND CHRIS	DNS	Sen	00	KUL

4 x 400 mètres TC Dames Heure de l'annonce officielle:20:01
Serie:1 (temps manuel)

1	BEL 1	3'40.1	
2101	LIBERT LAETITIA		USBW
1350	DAELEMANS SOFIE		ACME
1021	Efonye Kimberley		ATLA
1376	Grillet Justien		VS

2	CZ	3'54.4	
9989	PALUKOVA ADRIANA		
9988	VALESOVA PAULA		
9986	COCHEROVA JANA		
9987	KRATOCHVILOVA ALBERTA		

3	HELP	4'41.5	
1976	HEMROULLE PASCALINE		HEPL
9911	CORRE Morgane		HEPL
590	DUMOULIN VICTORIA		HEPL
9914	ROYBIER MAUD		HEPL

4	NED 1	DNF	
9990	KLAVER LIEBE		
9937	WIJCK Gabriella		OPEN
9930	BERENDSE Silke		OPEN
9945	BALTES Debbie		OPEN

4 x 400 mètres Sen Hommes Heure de l'annonce officielle:19:52
Serie:1 (temps manuel)

1	TORH	3'32.8	
9950	VANBELLEGEM WOUT		TOR
9951	COLPAERT MICHIEL		TOR
9952	CRUYT GERT		TOR
9953	VANDALE STEIN		

4 x 100 mètres Sen Hommes Heure de l'annonce officielle:19:28
Serie:1

1	BEL TC	42.34s	
829	DEGAVRE LIONEL		HERV
219	FRANCOIS LAURENS		OEH
811	Brunin Clement		MOHA
3178	KAPENDA RAPHAEL		SMAC

2	BEL SCOL	43.45s	
3167	PAQUOT JORDAN		SER
2195	HUYBRECHTS TIM		AVT
2252	Capiau Tobias		DEIN
3177	KAPENDA NATHAN		SMAC

	BEL JUNIOR A	DIS	
124	Muermans Maxim		ATLA
2529	Leflot Tyron		LYRA
183	De Meulemeester Alan		UGe
123	HENRY LAURENT		ATLA

4	NED WJK	DNF	
9921	ELABEIDI Jamiro		OPEN
9918	HEIJNEN Noah		OPEN
9925	BROER Rodrigo Willy		OPEN
9927	PALAS Denisio		OPEN

5 ULB DNS

2925	Brabant Jonathan	
2854	DATOUSSAID MEHDI	
2944	Keita Franck	
2671	LORIS LIONEL	

4 x 100 mètres Sen Dames Heure de l'annonce officielle:19:57
Serie:1

1 NED WJK 47.79s

9990	KLAVER LIEBE	
9937	WIJCK Gabriella	OPEN
9930	BERENDSE Silke	OPEN
9945	BALTES Debbie	OPEN

2 HECH 61.32s

1946	VANSTRAELEN CARINE	HECH
9991	MINET ANGELINE	HECH
2012	SCHYNS MELANIE	HECH
9913	ALEXANDER Catherine	HECH

BEL JUN 2 DIS

3537	BEAUCARNE CHLOE	DEIN
4173	Fickers Marie	LACE
130	DE CONINCK NENAH	KAAG
3273	Depuydt Manon	HCO

BEL JUN 1 DNF

177	Missinne Sarah	KAAG
688	LEPRINCE LAURA	Schu
366	DEPUYDT ORPHEE	HAC
379	MEHUYS ELISE	KUL

Lancers et Sauts

Saut à la perche TC Dames Heure de l'annonce officielle:15:14

1	1524	Andries Lien	3.50m	Sen	93	khle
2	2041	D Otreppe Mathilde	3.40m	Sen	94	ucl
3	957	De Laet Eva	3.00m	Sen	93	uhas
4	1579	Quirin Laura	2.80m	Sen	90	ugen
5	620	Watteyne Manon	2.50m	Jun	95	hesp
6	4049	Ancion Anna	2.50m	Sco	98	HERV
7	1679	Lerch Estelle	2.40m	Cad	99	HERV
	1562	Laing Brittany	DNS	Sen	94	kul
	4110	Joannes Marie	DNS	Sco	97	csdy
	363	De Vocht Elien	DNS	Jun	95	tmm

Saut en hauteur TC Hommes Heure de l'annonce officielle:15:23

1	2579	Makena Lois	2.08m	Sen	93	CSDY
2	1931	Delvaux Dieter	1.93m	Sen	92	kul
3	1536	Vande Berg Baptiste	1.90m	Sen	93	BERT
4	486	Kalandula Fabiano	1.85m	Jun	96	SPVI
5	1880	Daelemans Robin	1.85m	Sen	92	kul
6	1948	Galle Pieter	1.75m	Sen	94	kul
7	2729	Vandecapelle Mattijs	1.75m	Sen	89	RESC
8	2802	Vanstraelen Laurent	1.70m	Sen	91	help
9	726	Hans Bastien	1.70m	Jun	95	ulg
10	2588	Lejeune Bastien	1.65m	Sen	93	herc
	2919	Elsen Daan	NR	Sen	94	vub

Lancer du poids 7,260kg TC Hommes Heure de l'annonce officielle:14:14

1	1265	Denissen Jelle	13.68m	Sen	91	kul
2	2920	Xhonneux Frédéric	13.57m	Sen	83	RESC
3	1930	Frijters Pieter	13.15m	Sen	90	kul
4	3103	Namurois Bertrand	12.08m	Sen	91	ulg
5	9934	busch frederick	10.86m		89	ulb
6	6197	Matanda Kaiji Didier	10.13m	Mas	72	CSDY
7	2673	Adjanor Fabrice	8.47m	Sen	92	ulb
	361	Geuskens Willem	DNS	Jun	95	kul
	2206	Buffel Nick	DNS	Sen	94	kaho
	2776	Depoorter Youri	DNS	Sen	94	ulb
	2682	Lejeune Thomas	DNS	Sen	91	RFCL
	170	Seutin Bernard	DNS	Jun	95	kul

Triple-saut TC Dames Heure de l'annonce officielle:14:42

1	1417	Lenchant Sietske	12.83m	+0.1m/s	Sen	93	kul
2	1432	Mievis Stefie	11.80m	+1.0m/s	Sen	93	ugen
3	1993	Loureiro Elsa	11.75m	+0.4m/s	Sen	92	helm
4	1627	Rumbin Pauliina*	11.16m	-0.3m/s	Sen	89	kul
5	529	Hustin Solene	10.52m	+0.6m/s	Jun	95	ucl
6	616	Van Laar Aurore	10.24m	+1.0m/s	Jun	96	HERV

Lancer du poids 4,000kg TC Dames Heure de l'annonce officielle:15:29

1	1914	Thiam Nafissatou	14.85m		Sen	94	ulg
2	236	De Pauw Yoika	12.93m		Jun	95	ugen
3	2094	Borbouse Moly	12.44m		Sen	93	hers
4	9938	boldrini simona	11.79m			00	kul
5	989	Van Nieuwenhuyse Els	11.11m		Sen	92	kul
6	74	Hooyberghs Elien	11.03m		Jun	95	tmk
7	1207	Umans Kirsten	10.39m		Sen	93	ap
8	9920	lagrou anke	10.11m			92	kul
9	1867	Guisse Shaena	8.99m		Sen	94	ulb
10	1208	Van De Voorde Freya	8.57m		Sen	90	kdg
11	9907	delsaux claudine	7.83m			93	helm
	2050	Mastail Catherine*	DNS		Sen	93	SMAC

Triple-saut TC Hommes Heure de l'annonce officielle:16:10

1	2679	Marbaix Loic	14.19m	+1.2m/s	Sen	92	hesp
2	602	Renard Pierrick	14.08m	+1.6m/s	Jun	95	ulg
3	2598	Collin Gael	12.75m	-0.6m/s	Sen	89	RFCL

4	3116	Gelise Romain	12.61m	+1.4m/s	Sen	91	RFCL
5	601	Castanier Nathan*	12.47m	+1.0m/s	Jun	95	RESC
6	2014	De Herdt Gorik	12.42m	+0.2m/s	Sen	90	ap
7	897	Loucou Yann	12.41m	+0.6m/s	Jun	96	SER
8	3271	Haubursin Kevin	11.96m	-0.5m/s	Sco	97	CSF
9	2673	Adjanor Fabrice	11.51m	-0.7m/s	Sen	92	ulb

Saut en hauteur TC Dames Heure de l'annonce officielle:16:32

1	1417	Lenchant Sietske	1.70m	Sen	93	kul
2	4026	Leonard Sarah	1.60m	Sco	97	FCHA
3	534	Bekisz Sophie	1.60m	Jun	95	ulg
4	1995	Vanlandeghem Lydie	1.55m	Sen	92	ulb
5	1190	De Vogelaer Sarah	1.55m	Sen	89	kul
	957	De Laet Eva	NR	Sen	93	uhas

Lancer du disque 2,000kg TC Hommes Heure de l'annonce officielle:16:41

1	1265	Denissen Jelle	44.19m	Sen	91	kul
2	2920	Xhonneux Frederic	40.80m	Sen	83	RESC
3	2919	Elsen Daan	40.54m	Sen	94	vub
4	1930	Frijters Pieter	39.49m	Sen	90	kul
5	1951	Engels Lorenz	38.47m	Sen	86	kaho
6	2729	Vandecapelle Mattijs	38.13m	Sen	89	RESC
7	3103	Namurois Bertrand	34.07m	Sen	91	ulg
8	3035	Gets Florent	32.32m	Sen	91	hevi
9	9934	busch frederick	28.28m		89	ulb
	9915	cheval vincent	DNS		00	ulb
	893	Boa Michael	DNS	Jun	95	RESC
	2776	Depoorter Youri	DNS	Sen	94	ulb
	2722	Meskine Massimo	DNS	Sen	83	ACLO
	851	Porru Tommaso	DNS	Jun	96	SER
	2206	Buffel Nick	DNS	Sen	94	kaho

Saut à la perche TC Hommes Heure de l'annonce officielle:19:37

1	9947	vanderwest koen	4.70m		00	dcla
2	170	Seutin Bernard	4.20m	Jun	95	kul
3	2406	Stragier Bruno	4.20m	Sen	93	kul
4	2838	Van Weyenberg Alexis	4.00m	Sen	91	ucl
5	3242	Joannes Loic	3.80m	Sen	94	unam
6	9916	johnen antoine	3.70m		00	helm
7	3131	Godts Joscha	3.60m	Sen	93	ulb
8	9948	agnetti luc	3.60m		00	ser
9	9931	klerkx jordy	3.60m		00	unit
10	6681	Renkin Jean Paul	3.50m	Mas	64	HF
11	9932	hobma ernest	3.40m		00	unit
12	3386	Bertrand Pierre	3.00m	Sco	97	RFCL
13	3509	Vosse Valentin	2.60m	Sco	98	RFCL
	1648	Samaniuk Joseph*	NR	Sen	84	DCLA
	1375	makena lois	DNS		93	csdy
	2682	Lejeune Thomas	DNS	Sen	91	RFCL
	9903	marbehant robin	NR		00	helm
	1	Broeders Ben	NR	Jun	95	DCLA
	2929	Darquennes Raphael	NR	Sen	90	ucl
	9929	verberne cyriel	DNS		00	unit

Saut en longueur TC Dames Heure de l'annonce officielle:17:09

1	622	Fleury Alice	5.59m	-0.3m/s	Jun	95	ucl
2	157	Ceyssens Linde	5.53m	-1.0m/s	Jun	96	AVT
3	9946	jones laurence	5.45m	+0.1m/s		00	lux

4	1397	Schauwers Manon	5.38m	-0.7m/s	Cad	99	HF
5	1993	Loureiro Elsa	5.23m	-0.5m/s	Sen	92	helm
6	1966	Chevalier Alicia	4.97m	-0.5m/s	Sen	93	ucl
7	616	Van Laar Aurore	4.83m	-0.2m/s	Jun	96	HERV
8	1830	Lins Noémie	4.80m	-0.6m/s	Sen	94	RESC
9	4425	Kitenge Elysabeth	4.43m	-1.8m/s	Sco	97	RFCL
10	2044	Malpas Anais	4.25m	-1.3m/s	Sen	92	hepl
11	641	Fransquet Kadidja	4.15m	-0.9m/s	Jun	96	SER
12	2039	Franck Amelie	3.55m	-0.8m/s	Sen	91	HERV
	1195	Heijndrickx Ines	DNS	+0.0m/s	Sen	93	ugen

Lancer du disque 1,000kg TC Dames Heure de l'annonce officielle:18:22

1	9938	boldrini simona	43.78m			00	kul
2	3326	Vandeput Babette	42.16m	Sco		98	ATLA
3	2094	Borbose Moly	41.85m	Sen		93	hers
4	538	Josse Laetitia	40.61m	Jun		95	umon
5	1400	Dodrimont Emilie	39.10m	Cad		99	HF
6	989	Van Nieuwenhuysse Els	35.40m	Sen		92	kul
7	9920	lagrou anke	32.55m			92	kul
8	1208	Van De Voorde Freya	31.80m	Sen		90	kdg
9	1867	Guisse Shaena	30.05m	Sen		94	ulb
10	692	Sotiau Anais	24.00m	Jun		95	HERV

Lancer du javelot 800g TC Hommes Heure de l'annonce officielle:17:49

1	2616	Branders Timothy	55.85m	Sen		94	hers
2	1198	Hooyberghs Jens	54.03m	Sen		93	kul
3	851	Porru Tommaso	48.45m	Jun		96	SER
4	2919	Elsen Daan	47.85m	Sen		94	vub
5	2729	Vandecapelle Mattijs	44.26m	Sen		89	RESC
6	3103	Namurois Bertrand	44.15m	Sen		91	ulg
7	838	Beeckman Amaury	43.83m	Jun		95	ulb
8	2666	Nysten Valere	42.77m	Sen		94	ucl
9	170	Seutin Bernard	34.88m	Jun		95	kul
10	2830	Dessy Benoit	28.12m	Sen		87	HERV
	2673	Adjanor Fabrice	DNS	Sen		92	ulb

Saut en longueur TC Hommes Heure de l'annonce officielle:19:15

1	1278	Broothaerts Mathias	7.50m	-0.9m/s	Sen	94	ua
2	2628	Lambert Romain	7.20m	-1.2m/s	Sen	93	ucl
3	3095	Grailet Francois	6.83m	-1.1m/s	Sen	94	ulg
4	2252	Capiau Tobias	6.82m	-2.2m/s	Sco	97	DEIN
5	2920	Xhonneux Frederic	6.63m	-2.2m/s	Sen	83	RESC
6	2671	Loris Lionel	6.35m	-1.4m/s	Sen	91	ulb
7	9941	kieffer donald	6.32m	-1.2m/s		00	lux
8	602	Renard Pierrick	6.21m	-0.8m/s	Jun	95	ulg
9	361	Geuskens Willem	6.15m	-0.2m/s	Jun	95	kul
10	2679	Marbaix Loic	6.13m	-2.3m/s	Sen	92	hesp
11	2776	Bijnens Niels	6.08m	-1.3m/s	Sco	97	ATLA
12	601	Castanier Nathan*	6.08m	-2.3m/s	Jun	95	RESC
13	2711	Detry Lionel	5.88m	-2.0m/s	Sen	94	CABW
14	2598	Collin Gael	5.85m	-1.3m/s	Sen	89	RFCL
15	3116	Gelise Romain	5.80m	-2.5m/s	Sen	91	RFCL
16	9935	lecuyer jordan	5.58m	-1.0m/s		00	rfcl
17	2892	Stempnick Nicolas	5.08m	-3.7m/s	Sen	89	DS
18	2798	Mairesse Olivier	4.97m	-0.9m/s		89	ulb
19	3176	Martinesse Emmanuel	4.58m	-0.6m/s	Sen	88	FAC
20	2673	Adjanor Fabrice	4.50m	-0.4m/s	Sen	92	ulb
21	1794	chasseur adrien	4.40m	-0.7m/s		00	fac
22	3047	Quittelier Jason	3.28m	-1.2m/s	Sen	90	FAC

1650 Pittomvils Niels NR +0.0m/s Sen 92 LOOI

Lancer du javelot 600g TC Dames Heure de l'annonce officielle:18:40

1	622	Fleury Alice	42.63m	Jun	95	ucl
2	1315	Van Royen Carolien	40.51m	Sen	92	ugen
3	1207	Umans Kirsten	38.10m	Sen	93	ap
4	2008	Simon Celine	36.26m	Sen	92	unam
5	1165	Verlinden Hannelaure	35.45m	Sen	92	kul
6	1995	Vanlandeghem Lydie	20.81m	Sen	92	ulb

Mercredi 12 mars 2014

Championnat Enseignement Supérieur



INFORMATIONS GENERALES :

- * **HORAIRE** : Début des compétitions à partir de 10h.
- * **LIEU** : Sportcomplex UGent (GUSB), Watersportlaan 3, 9000 Gent.
- * **INFOS** : Catégories A/B1/B2/C1/C2/D&NC
Qualifications : poules de 3-4 étudiants. Second tour : 1/8-1/4-1/2-Finale.
- * **REGLES** : 2 sets gagnants jusque 21 points (3ième set : changement de coté à 11 points).
- * **EQUIPEMENT** : Volants plumes fournis à partir des 1/8 finales.

INSCRIPTIONS :

En ligne via le lien : <http://www.aseus.be/formulaire/2139>

Clôture le vendredi 7/03/2014, 16h.

Attention, clôture anticipative possible sous réserve des disponibilités.

Le responsable sport de ton institution recevra une confirmation de ton inscription par mail.

Inscris-toi sans attendre grâce à ton smartphone et ce QR-CODE !



Résultats du Championnat FSUB de Badminton

Gent

Mercredi 12 mars 2014



BUSF / FSUB BADMINTON - UITSLAGEN /RESULTATS

DAMES A (6 dlns)

- | | | |
|----|-----------------|----------|
| 1. | Présence BEELEN | HE Namur |
| 2. | Silke BARREZ | KULeuven |
| 3. | Charlot PHILIPS | UGent |

HEREN A (5 dlns)

- | | | |
|----|-----------------|-------|
| 1. | Kris DEDONCKER | UGent |
| 2. | Tom ACKE | KHLim |
| 3. | Nicolas CARRAGI | VUB |

DAMES B1 (10 dlns)

- | | | |
|----|--------------|----------|
| 1. | Helena COCKX | KULeuven |
| 2. | Nele HAYEN | KULeuven |
| 3. | Siel DEMEYER | KULeuven |

HEREN B1 (12 dlns)

- | | | |
|----|----------------|-------------|
| 1. | Robin CUVELIER | HE Ph SPAAK |
| 2. | Flavien HELSON | UCL |
| 3. | Jeroen BECKERS | KULeuven |

DAMES B2/C1 (5 dlns)

- | | | |
|----|------------------|-------|
| 1. | Elisa VANDEWIELE | UGent |
| 2. | Clotilde BORIE | UCL |
| 3. | Séverine DETAYA | UCL |

HEREN B2 (13 dlns)

- | | | |
|----|-------------------|----------------|
| 1. | Robin VANDERAVERO | HE L. De Vinci |
| 2. | Benoit DE ROOMS | ICHEC |
| 3. | Glenn SPILEERS | ARTEVELDE |

HEREN C1 (8 dlns)

- | | | |
|----|--------------------|-----------|
| 1. | Cyriel VERSCHAEREN | ARTEVELDE |
| 2. | STEVEN COECKELBERG | HOWEST |
| 3. | NIELS DE VOS | UGent |

HEREN C2 (5 dlns)

- | | | |
|----|----------------|------------|
| 1. | Emiel OSTYN | ERM/KMS |
| 2. | Laurens DE KOK | KHLeuven |
| 3. | Ward DE RIDDER | UAntwerpen |

DAMES D/NG (6 dlns)

- | | | |
|----|--------------------|----------|
| 1. | Marieke MISPELAERE | UGent |
| 2. | Cécile LAURAIN | HEPLg |
| 3. | Lotte GEERTS | ARTVELDE |

HEREN D/ng (14 dlns)

- | | | |
|----|-------------------|---------|
| 1. | Thibault REINDERS | HEPLg |
| 2. | Sebastien ONYN | UGent |
| 3. | Bastien MERGEAI | ERM/KMS |

Heren A

	EINDSTAND	
1.	Kris DENDONCKER	UGent
2.	Tom ACKE	KHLim
3.	Nicolas CARRAGGI	VUB
4.	Stanie SIMONS	KDG
5.	Thijs DEMEYERE	UGent

Dames A

	EINDSTAND POULE 1	
1.	Sielke BARREZ	KULeuven
2.	Charlot PHILIPS	UGent
3.	Sanne VERBEECK	UGent
	EINDSTAND POULE 2	
1.	Présence BEELEN	HE NAMUR
2.	Ine LANCKRIET	UGent
3.	Mercedes VAN DEN EYNDE	KDG

½ FINALES

Sielke BARREZ – Ine LANCKRIET **2 – 0**

Charlot PHILIPS - Présence BEELEN **0 - 2**

3° & 4° pl.

Charlot PHILIPS - Ine LANCKRIET **w.o.**

FINALE

Sielke BARREZ - Présence BEELEN **1 - 2**

Heren B1

	EINDSTAND POULE 1	
1.	Robin CUVELIER	HE PH SPAAK
2.	Ares DE GROOTE	KAHO St. L.
DNS	Remy SCHIKOWSKY	UCL
	EINDSTAND POULE 2	
1.	Flavien HELSON	UCL
2.	Koen MOUTON	KMS/ERM
3.	Ben VAN HERBRUGGEN	UGent
	EINDSTAND POULE 3	
1.	Jannes HELLEMANS	KULeuven
2.	Stefan MARTENS	UHasselt
3.	Arno BOONANTS	UGent

EINDSTAND POULE 4		
1.	Jeroen BECKERS	KULeuven
2.	Roy BAPTISTE	HEPLg
3.	Mickael CARDINAL	UCL

¼ FINALES

Robin CUVELIER - Roy BAPTISTE	2 - 0
Stefan MARTENS - Flavien HELSON	0 - 2
Jannes HELLEMANS - Koen MOUTON	2 - 1
Jeroen BECKERS - Ares DE GROOTE	2 - 0

½ FINALES

Robin CUVELIER - Jannes HELLEMANS	2 - 1
Flavien HELSON - Jeroen BECKERS	2 - 0

3° & 4° pl.

Jeroen BECKERS - Stefan MARTENS	2 - 1
---------------------------------	-------

FINALE

Robin CUVELIER - Flavien HELSON	2 - 1
---------------------------------	-------

Dames B1

EINDSTAND POULE 1		
1.	Helena COCKX	KULeuven
2.	Johana BREYNE	UGent
3.	Florence MULLER	UCL
EINDSTAND POULE 2		
1.	Nele HAYEN	KULeuven
2.	Nena DEDAuw	KULeuven
3.	Emma MUSSCHE	UGent
EINDSTAND POULE 3		
1.	Siel DEMEYERE	KULeuven
2.	Sigrid VERSCHOOREN	KULeuven
3.	Leni VAN KERCKHOVEN	KULeuven
4.	Stephanie Paar	UCL

½ FINALES

Nele HAYEN - Siel DEMEYERE	2 - 0
Helena COCKX - Sigrid VERSCHOOREN	2 - 0

3° & 4°pl.

Siel DEMEYERE - Sigrid VERSCHOOREN	2 - 0
------------------------------------	-------

FINALE

Nele HAYEN - Helena COCKX	2 - 0
---------------------------	-------

Dames B2/C1

EINDSTAND		
1.	Elisa VANDEWIELE	UGent
2.	Clotilde BORIE	UCL
3.	Séverine DETAYA	UCL
4.	Marie GILLARD	HEPLg

Heren B2

EINDSTAND POULE 1		
1.	Kristof CNOPS	KULeuven
2.	Xander VERPLANCKE	UGent
3.	Thijs BRONS	ARTEVELDE
EINDSTAND POULE 2		
1.	Christoph SCHOLS	KULeuven
2.	Julien COLMONTs	UCL
3.	Tamas GOMMERS	UGent
EINDSTAND POULE 3		
1.	Benoit DE ROOMS	ICHEC
2.	Thomas LAMBREGTS	KULeuven
3.	Thomas VERPRAET	KULeuven
EINDSTAND POULE 4		
1.	Robin VANDERAVERO	HE L DE VINCI
2.	Glenn SPILEERS	ARTEVELDE

1/4 FINALES

Kristof CNOPS - Glenn SPILEERS	0 - 2
Julien COLMONTs - Thomas LAMBREGTS	1 - 2
Benoit DE ROOMS - Christoph SCHOLS	2 - 0
Robin VANDERAVERO - Xander VERPLANCKE	2 - 0

1/2 FINALE

Glenn SPILEERS - Benoit DE ROOMS	0 - 2
Thomas LAMBREGTS - Robin VANDERAVERO	0 - 2

3° & 4° pl.

Glenn SPILEERS - Thomas LAMBREGTS	2 - 0
-----------------------------------	-------

FINALE

Benoit DE ROOMS - Robin VANDERAVERO	0 - 2
-------------------------------------	-------

Heren C1

EINDSTAND POULE 1		
1.	Niels DE VOS	UGent
2.	Séverin ARNAUD	ULB
3.	Hirouc SANDER	HOWEST
EINDSTAND POULE 2		
1.	Cyriel VERSCHAEREN	ARTEVELDE
2.	Steven COECKELBERGHS	HOWest
3.	Nicolas CALLEBAUT	UGent
4.	Jean-Charles SOVET	UCL

1/2 FINALES

Cyriel VERSCHAEREN - Séverin ARNAUD 2 - 1
Niels DE VOS - Steven COECKELBERGHS 0 - 2

5° & 6°pl.

Hirouc SANDER - Nicolas CALLEBAUT 1 - 2

3° & 4°pl.

Niels DE VOS - Séverin ARNAUD 2 - 0

FINALE

Cyriel VERSCHAEREN - Steven COECKELBERGHS 2 - 1

Heren C2

EINDSTAND		
1.	Emiel OSTYN	ERM/KMS
2.	Laurens DE KOK	KHLeuven
3.	Ward DE RIDDER	UAntwerpen
4.	Pengyue GAO	ULB

Heren D/ng

EINDSTAND POULE D		
1.	Thibault REINDERS	HEPLg
2.	Sebastien ONYN	UGent
3.	Cedric HUYGHENS	UCL
4.	Kevin DRESS	UCL
EINDSTAND POULE E		
1.	Bastien MERGEAI	ERM/KMS
2.	Clement BONNAY	ULB
3.	Alexis PELLETIER	HEPLg

EINDSTAND POULE F		
1.	Stijn HENRI	ERM/KMS
2.	Pierre BISSCHOPS	UCL
3.	Thibaut BRUNIER	HELBruxelles
EINDSTAND POULE G		
1.	Julien BORDES	HEPLg
2.	Jeroen RONDAGS	UAntwerpen
3.	Vincent POMMERET	HEPLg

1/4 FINALES

Thibault REINDERS - Jeroen RONDAGS	2 - 0
Bastien MERGEAI - Pierre BISSCHOPS	2 - 1
Stijn HENRI - Clement BONNAY	0 - 2
Sebastien ONYN - Julien BORDES	2 - 0

1/2 FINALES

Thibault REINDERS - Bastien MERGEAI	2 - 0
Clement BONNAY - Sebastien ONYN	0 - 2

3° & 4° pl.

Clement BONNAY - Bastien MERGEAI	0 - 2
---	--------------

FINALE

Thibault REINDERS - Sebastien ONYN	2- 1
---	-------------

DAMES NG

EINDSTAND POULE 1		
1.	Cécile LAURAIN	HEPLg
2.	Lotte GEERTS	ARTEVELDE
w.o.	Alix ANDRIEU	Ulg
EINDSTAND POULE 2		
1.	Marieke MISPELAERE	UGent
2.	Amandine IBANEZ	HEPLg
3.	Manon SOUCHU	HEPLg

1/2 FINALES

Cécile LAURAIN - Amandine IBANEZ	2 - 0
Marieke MISPELAERE - Lotte GEERTS	2 - 0

3° & 4° pl.

Amandine IBANEZ - Lotte GEERTS	0 - 2
---------------------------------------	--------------

FINALE

Marieke MISPELAERE - Cécile LAURAIN	2- 1
--	-------------

Dimanche 1^{er} décembre 2013 Championnat Enseignement Supérieur

INFORMATIONS GENERALES :

- * **HORAIRE** : départ entre 10h et 11h30, accueil entre 9h30 et 11h30, remise des prix à 13h30.
- * **CIRCUITS** :
Championnat officiel :
D. : 6 km & H. : 9 km.
Débutants : 3km.
- * **Rendez-vous** :
Salle du Patro
Rue Léopold II
6530 Thuin
Balisage depuis l'église de Gozée (direction Thuin).
- * Carte IOF 1/4000 normes ISSOM
- * Traceur : Tom DRYGALSKI

INSCRIPTIONS :

En ligne via le lien : <http://www.aseus.be/formulaire/2939>

Clôture le vendredi 25/11/2013 à 09h30.

Attention, clôture anticipative possible sous réserve de disponibilités.

Le responsable sport de ton institution recevra une confirmation de ton inscription par mail.

Inscris-toi sans attendre grâce à ton smartphone et ce QR-CODE !



Résultats du Championnat FSUB de Course d'Orientation

THUIN

Dimanche 1 décembre 2013



Championnat Universitaire Course d'Orientation Thuin – 1 décembre 2013

Messieurs – 8580 m

1. Tristan BLOEMEN	KUL	61.08
2. Julien GILLET	UCL	61.33
3. Clément DEMEUSE	UCL	65.27
4. Quentin DE NEYER	UCL	73.22
5. Thibaut DERENNE	ULg (Gembloux)	80.15
6. Dieter COEN	U Gent	82.26
7. Ian GELDOF	U Hasselt	82.51
8. François CLAPUYT	UCL	85.14
9. Eloi STEYAERT	ERM	86.05
10. Hans MERKEN	ERM	89.52
11. Philippe DELANDMETER	UCL	139.09
-- Florent HAINAUT	ERM	N.CI.
-- Sébastien GUILLAUME	HE en Hainaut	N.CI.

Dames – 5460 m

1. Anna SERRALLONGA	KUL	52.17
2. Tiphane MARCHEGAY	HE Libre Bruxelles	60.29
3. Anne Laure CELENZA	UCL	75.30
-- Cheyenne DELL'ANESE	UMons	N.CI.

Jeudi 1er mai 2014

Championnat Enseignement Supérieur

INFORMATIONS GENERALES :

- * **Départ : 15h30 de Dorpplaats.**
- * **Distance : 88,4 km en 17 boucles de 5,2 km.**
ELITE DAMES 1.15
- * **Lieu : Centre de Boortmeerbeek, Terrain de l'entreprise «Pierre Baeck»**
Départ à hauteur des bâtiments de l'entreprise,
(à hauteur du numéro 55 de la rue Wespelaarsebaan).
- * **Prix : Barème de la RLVB, remboursement éventuel auprès de ton école.**

INSCRIPTIONS :

- De 14h15 à 15h15 sur place.
Obligatoire : être en possession de sa carte d'étudiant et de sa license RLVB
(pas de possibilité d'achat de license d'un jour).

Contact étudiants : Geert Delporte 09/264.63.14 jules.delporte@ugent.be
Contact organisateur : K. WielerClub de Verenigde Sportvrienden
Pieter PAUWELS 015/51.67.54 ou 0474/87.57.00
info@wielerclubdeverenigdesportvrienden.be
website:www.wielerclubdeverenigdesportvrienden.be



Résultats du Championnat FSUB de Cyclisme Dames

Boortmeerbeek

Jeudi 1 mai 2014



UITSLAG BK WIELRENNEN DAMES 01/05/2014 BOORTMEERBEEK

1.15 Dames Elite - Open omloop 88 km

BK voor Dames studenten

Deelnemers: 75 (16 STUDENTEN)

Opgevers: 27

Afstand: 88.400 km-Tijd: 2:16'10" - Gem. snelheid: 38.952 km/h

	1	VAN DER MEULEN Kaat		BEL19950622	2H16'10"
	2	POSTMA Mary Rose		NED19840824	z.t.
1°	3	INGHELBRECHT Sarah	UGent	BEL19921001	
	4	FOREMAN-MACKEY Annie		CAN19910626	
	5	VAN DOORSLAER Annelies		BEL19890115	
	6	JOCHEMS Sigrid		NED19871006	2H17'37"01'27"
	7	DUTRIAUX Fiona		FRA19890125	z.t.
	8	GINs Tara		BEL19901202	
	9	DRUYTS Kelly		BEL19891021	
	10	VAN DEN STEEN Goedele		BEL	
2°	11	VAN GLABEKE Shana	ARTVELDE	BEL19930928	
	12	DEBBOUDT Lensy		BEL19770920	
	13	NIJNS Nathalie		BEL19930701	
3°	14	DRUYTS Demmy	A Plantin	BEL19951004	
	15	MILTENBURG Ilse		NED19950817	
4°	16	DERGENT Eveline	Th Moore	BEL19920622	
	17	KULLMERLisa		GER19930615	
	18	RATHMANN Annette		GER19850523	
	19	MEYVISCH Molly		BEL19951027	
	20	ROELEN Evy		BEL19940927	
	21	THOMAS Claire		GBR19721209	
5°	22	WINTGENS Marlène	HE Plième	BEL19930217	
	23	ROBERT Valerie		BEL19910701	
	24	VLEUGELS Jolien		BEL19940527	
	25	BORREMANS Sarah		BEL19880804	
6°	26	VERSCHELDEN Nathalie	UGent	BEL19940726	
	27	PEETERS Charlotte		NED19880623	
7°	28	DE ROOVER Eline	Th Moore	BEL19920404	
	29	BECK Luisa		GER19891027	
	30	CORTHOUT Shauni		BEL19931128	
	31	VAN DEN STEEN Kim		BEL19940526	
	32	CEULEMANS Dunja		BEL19890912	
	33	ACCOE Joyce		BEL19870222	
8°	34	DENEFF Naika	HOWEST	BEL	
	35	DEBBOUDT Evelien		BEL19840924	
	36	FREMINEUR Terry		BEL19860901	
	37	ELST Natalie		BEL19910904	
9°	38	LIESENS Karolien	PXLim	BEL19941011	
	39	VERHAEST Sara		BEL19951213	
	40	DE JONG Jamie		NED19951205	
	41	KLEIN Theres		GER19890904	
	42	VAN DEN STEEN Kelly		BEL19950901	
	43	ARNOUts Lauren		NED19941109	
	44	KOEP Christina		GER19930318	
	45	VERCAMMEN Ine		BEL19770107	
	46	MAES Shana		BEL19950202	
	47	DE RAVET Karolien		BEL19920502	
	48	DESSUREAULT Catherine		CAN19830121	

DNF 27 deelnemers

Samedi 19 avril 2014

Championnat Enseignement Supérieur

INFORMATIONS GENERALES :

- * **Départ** : 15h15 de Dorpplaats.
- * **Distance** : 80 km en boucle d'environ 6 km.
1.12c OPEN (Am/Mast/B.EL.zc/BU-23)
- * **Lieu** : Schoolstraat 6, 3690 Zutendaal, zaal Avdaq
- * **Prix** : Barème de la RLVB, remboursement éventuel auprès de ton école.

INSCRIPTIONS :

- De 13h30 à 14h45 sur place.
Obligatoire : être en possession de sa carte d'étudiant et de sa license RLVB
(possibilité d'achat de license d'un jour).

Contact étudiants : Geert Delporte 09/264.63.14 jules.delporte@ugent.be
Contact organisateur : Wielierclub Zutendaal
Kurt Keppers 0477/76.21.59
kurt.keppers@edpnet.be
<http://www.zutendaalbikers.be/#Startpagina>



Résultats du Championnat FSUB de Cyclisme Hommes

Zutendaal

Samedi 19 avril 2014

































































































UITSLAG BK Wielrennen - 19 april 2014 ZUTENDAAL

1.12.C Open Indiv.(Am/Mast./B.El.zc/B.U23)

Deelnemers: 166 (46 studenten); opgevers: 69

Afstand: 80.000 km-Tijd: 1:47'36"-Gem. snelheid: 44.610 km/h

UITSLAG STUDENTEN	UITSLAG WEDSTRIJD	UNIVERSITEIT / HOGESCHOOL
1	 LUYCKX Brent	THOMAS MORE (Kempen)
2	 BEELEN Boris	HE HELMO
3	 VAN RENTERGHEM Bram	UGent
	 VAN DER SANDEN Mathias	
4	 HAEMELS Bavo	KDG
5	 VANSTAEN Roman	KULeuven
	 BIERMANS Gregory	
	 ELEN Sander	
	 ESSELAAR Remco	
	 VERSTRAETE Peter	
	 FROYEN Piet	
6	 12 CLAUS Dieter	UGent
7	 13 WOLKOWICZ Romain	HE Charlemagne
	 VANCALDENBORGH Rick	
	 CLAES Gert	
	 VERCAMMEN Sven	
	 JAME Stefan	
8	 18 GOOSSENS Maarten	HIKempen
9	 19 COERTJENS Rien	GROEP T
	 THEUNISSEN Jordi	
10	 21 HAOT Maxime	HE Charlemagne
	 VAN SCHELVEN Jeroen	
	 VANDERAERDEN Niels	
	 VANDENHOUDT Jens	
	 VANHOVE Joeri	
	 VAN DYCK Wesley	
	 VAN UYTSEL Tomas	
	 MELLEMANNS Jeffrey	
	 DEFAUWES Roel	
	 VANHOVE David	
	 VIERLING Gijs	
	 LOTZ Stephan	
	 MIESSEN Christian	
11	 34 RAMAEKERS Jochen	PHLimburg
12	 35 DELANGHE Jelle	KULeuven
	 CREMER Thomas	
	 DUCHATEAU Filip	
	 GAUDAEN Tom	
	 ROSIUS Raf	
	 AANDEWIEL Pascal	
13	 41 VERBEEK Wout	KULeuven
	 CUMPS Ruben	
14	 43 HENNEAU Martijn	KHLeuven
15	 44 DESAIR Maarten	PHLim
	 STEVENS Andy	
16	 46 PEPINSTER Sébastien	HE HELMO
17	 47 WOUTERS Ruben	PHLim

18	48	 GROFFI Dario	KULeuven
	49	 CARGNELLO Michel	
	50	 AERDEN Koen	
19	51	 SEVENICH Amd	HIKempen
	52	 VAN NUETEN Koen	
	53	 SMEYERS Hans	
	54	 WAUTERS Matthias	
	55	 LAFOURTE Jérôme	
20	56	 BUDO Nico	ULiège
	57	 GEORGOPALIS Dimitri	
	58	 DEMAN Renaud	
	59	 VAN HERREWEGHE Simon	
	60	 VAN ALPHEN Daan	
	61	 CANDEL Yanick	
	62	 BECQ Maxime	
	64	 VAES Niels	
	65	 STROUWEN Wesley	
	66	 BOSSERS Maarten	
	67	 VANDECAETSBECK Danny	
	68	 RONCADA Valentino	
	69	 BRUYNINCKX Yannick	
	21	70	
22	71	 ROLLAND Thomas	THOMAS MORE Kempen
	72	 LAVRIJSEN Mathias	
	73	 GOOSSENS Rojas	
	74	 MERTENS Bram	
	75	 VANGOETHEMD Svenne	
	76	 VAN EYNDT Sven	
	77	 ISENBORGHS Kristof	
	78	 DAS Jeroen	
	79	 BREUER Christoph	
	80	 THOME Kevin	
23	81	 HERREMANS Jamie	KULeuven
	82	 PEETERS Thomas	
	83	 CAUBERGH Rafael	
	84	 HAUTERAT Georges	
	85	 RUNIA Nick	
	86	 DE BOEL Stijn	
	87	 SCHOL Dieter	
	88	 DECLoux Steve	
	89	 WULTERKENS Koen	
	90	 VAN LOOY Roel	
	91	 DAELMAN Kristof	
	92	 STEVENS Senne	
	93	 VAN ELST Jonathan	
	94	 DONCKERS Bram	
	95	 VAN AAKEN Rik	
	96	 CLEEREN Tom	
	97	 WILLEMS Tom	

Le dimanche 30 Mars 2013 Championnat Enseignement Supérieur

INFORMATIONS GENERALES :

- * **Horaire** : 13h00 départ
- * **Infos** :
 - distances : 5 KM (course), 20 KM (Vélo), 2,5 KM (Course)
 - plus d'info : <http://www.aseus.be/championnats/details/3446>
- * **LIEU** :
Enclus Du Haut 53
7750 Mont De L'enclus

INSCRIPTIONS :

En ligne via le lien : <http://www.aseus.be/formulaire/3692>

Clôture le mercredi 26/03/2014 à 16h00.

Attention, clôture anticipative possible sous réserve de disponibilité.

Le responsable sport de ton institution recevra une confirmation de ton inscription par mail.

Inscris-toi sans attendre grâce à ton smartphone et ce QR-CODE !



Avec le soutien de :



Mercredi 19 février 2014

Championnat Enseignement Supérieur

INFORMATIONS GENERALES :

- * **HORAIRE** : dès 17h jusque +- 20h.
- * **LIEU** : **Katholieke Hogeschool Sint Lieven**,
Technologiecampus Gent, Gebroeders Desmetstraat 1, 9000 Gent.
La compétition se déroulera dans la cafétéria.
- * **INFOS** : Règlement FIDE (règles d'échecs rapides).
Catégorie : 7 rondes suisses 2 x 15' KO.
Ouvert à tous (membre ou non membre d'un club).

INSCRIPTIONS :

En ligne via le lien : <http://www.aseus.be/formulaire/2168>.

Clôture le mardi 11/02/2014, 16h.

Attention, clôture anticipative possible sous réserve des disponibilités.

Le responsable sport de ton institution recevra une confirmation de ton inscription par mail.

Inscris-toi sans attendre grâce à ton smartphone et ce QR-CODE !
Etre en possession de sa carte d'étudiant le jour de la compétition.



LID VAN
**ASSOCIATIE
KU LEUVEN**



Résultats du Championnat FSUB d'échecs

Katholieke Hogeschool Sint Lieven

Mercredi 19 février 2014



Belgisch Studentenkampioenschap 2014

KAHO St Lieven	(©) FRBE 2005	PairTwo 4.14	F.E.F.B.
	Org. :	KAHO St Lieven ,Gent ,2014	
	Arbit. :	Hans Temmerman	
	Tempo :	15 min KO	
	Tie Break	Pts, Bucholtz, Median Buch, Progressive	

R1	R2	R3	R4	R5	R6	R7
American Ranking						

Final Standing									
Tit	Name	Rati	F/M	Club	Cou	Pts	Buch	M B	Prg
1	Ponnet Hendrik	(2261N)	M	Landegem	BEL	6.5/7	---	---	---
2	Verhaeren Gertjan	(2121N)	M	KGSRL Gent	BEL	5.5/7	30.0	---	---
3	Van Houtte Randy	(1993N)	M	Wetteren	BEL	5.5/7	26.0	---	---
4	Theuerkauff Olivier	(1905N)	M	CREB Bruxelles	BEL	4.5/7	---	---	---
5	Van Laeken Jonathan	(1769N)	M	Mercatel	BEL	4.0/7	25.0	---	---
6	Proesmans Karel	(0)	M	Diepenbeek	BEL	4.0/7	23.5	---	---
7	Bourdeaud'Hui Jolan	(1668N)	M	FCH Zottegem	BEL	4.0/7	18.0	---	---
8	Roos David	(2111N)	M	Zottegem	BEL	3.5/7	31.5	---	---
9	Kidzinski Lukasz	(2052N)	M	CREB Bruxelles	POL	3.5/7	24.5	---	---
10	De Bode Joren	(1552N)	M	Zottegem	BEL	2.0/7	---	---	---
11	Kazakevich Dzianis	(0)	M		BEL	1.0/7	24.0	---	---
12	Demey Robbe	(1757N)	M	Aalter	BEL	1.0/4	23.5	---	---
13	Brysse Adriaan	(0)	M		BEL	1.0/4	21.0	---	---
14	Parsai Ali	(1758N)	M	Hoboken	BEL	0.0/0	24.5	17.5	---
15	Marchand Geoffrey	(1168N)	M	Lokeren	BEL	0.0/0	24.5	17.5	---
16	Brivet-Naudot Cyril	(0)	M		BEL	0.0/0	24.5	17.5	---
17	Bodson Bruno	(0)	M		BEL	0.0/0	24.5	17.5	---
18	Goossenaerts Tom	(0)	M		BEL	0.0/0	24.5	17.5	---
19	Muhire Jean Michel	(0)	M		BEL	0.0/6	19.0	---	---

HUB
 Hogent
 Hogent
 ULB
 Ugent
 Ugent
 ?
 Kaho
 ULB
 Kuleuven
 UHasselt
 HUB
 Kaho
 UA
 Ugent
 ULB
 Kaho
 TMA
 Umons.

[Top of Page](#)

Round 1 (19-02-2014)

1	Ponnet Hendrik	(1)	1-0	Van Laeken Jonathan	(7)
2	Demey Robbe	(9)	0-1	Verhaeren Gertjan	(2)
3	Roos David	(3)	1-0	Bourdeaud'Hui Jolan	(10)
4	De Bode Joren	(11)	0-1	Kidzinski Lukasz	(4)
5	Van Houtte Randy	(5)	1-0	Kazakevich Dzianis	(17)
6	Proesmans Karel	(18)	0-1	Theuerkauff Olivier	(6)
7	Brysse Adriaan	(19)	Bye		
	Bodson Bruno		Absent		
	Brivet-Naudot Cyril		Absent		
	Goossenaerts Tom		Absent		
	Marchand Geoffrey		Absent		
	Muhire Jean Michel		Absent		
	Parsai Ali		Absent		

[\(Go to Top\)](#)**Round 2 (19-02-2014)**

1	Kidzinski Lukasz	(4)	0-1	Ponnet Hendrik	(1)
2	Verhaeren Gertjan	(2)	1-0	Van Houtte Randy	(5)
3	Brysse Adriaan	(19)	0-1	Roos David	(3)
4	Theuerkauff Olivier	(6)	1-0	Demey Robbe	(9)
5	Van Laeken Jonathan	(7)	1-0	De Bode Joren	(11)
6	Bourdeaud'Hui Jolan	(10)	0-1	Proesmans Karel	(18)
7	Kazakevich Dzianis	(17)	1-0	Muhire Jean Michel	(14)
	Bodson Bruno		Absent		
	Brivet-Naudot Cyril		Absent		
	Goossenaerts Tom		Absent		
	Marchand Geoffrey		Absent		
	Parsai Ali		Absent		

[\(Go to Top\)](#)**Round 3 (19-02-2014)**

1	Ponnet Hendrik	(1)	1-0	Theuerkauff Olivier	(6)
2	Roos David	(3)	0-1	Verhaeren Gertjan	(2)
3	Kazakevich Dzianis	(17)	0-1	Kidzinski Lukasz	(4)
4	Van Houtte Randy	(5)	1-0	Brysse Adriaan	(19)
5	Proesmans Karel	(18)	0-1	Van Laeken Jonathan	(7)
6	Demey Robbe	(9)	1-0	De Bode Joren	(11)
7	Muhire Jean Michel	(14)	0-1	Bourdeaud'Hui Jolan	(10)
	Bodson Bruno		Absent		
	Brivet-Naudot Cyril		Absent		

Goossenaerts Tom	Absent
Marchand Geoffrey	Absent
Parsai Ali	Absent

[\(Go to Top\)](#)**Round 4 (19-02-2014)**

1 Verhaeren Gertjan	(2)	0-1	Ponnet Hendrik	(1)
2 Theuerkauff Olivier	(6)	½-½	Roos David	(3)
3 Kidzinski Lukasz	(4)	0-1	Van Houtte Randy	(5)
4 Van Laeken Jonathan	(7)	1-0	Kazakevich Dzianis	(17)
5 Bourdeaud'Hui Jolan	(10)	1-0	Demey Robbe	(9)
6 Brysse Adriaan	(19)	0-1	Proesmans Karel	(18)
7 De Bode Joren	(11)	1-0	Muhire Jean Michel	(14)
Bodson Bruno		Absent		
Brivet-Naudot Cyril		Absent		
Goossenaerts Tom		Absent		
Marchand Geoffrey		Absent		
Parsai Ali		Absent		

[\(Go to Top\)](#)**Round 5 (19-02-2014)**

1 Ponnet Hendrik	(1)	½-½	Van Houtte Randy	(5)
2 Van Laeken Jonathan	(7)	0-1	Verhaeren Gertjan	(2)
3 Roos David	(3)	1-0	Kidzinski Lukasz	(4)
4 Bourdeaud'Hui Jolan	(10)	0-1	Theuerkauff Olivier	(6)
5 Muhire Jean Michel	(14)	0-1	Proesmans Karel	(18)
6 Kazakevich Dzianis	(17)	0-1	De Bode Joren	(11)
Bodson Bruno		Absent		
Brivet-Naudot Cyril		Absent		
Brysse Adriaan		Absent		
Demey Robbe		Absent		
Goossenaerts Tom		Absent		
Marchand Geoffrey		Absent		
Parsai Ali		Absent		

[\(Go to Top\)](#)**Round 6 (19-02-2014)**

1 Roos David	(3)	0-1	Ponnet Hendrik	(1)
2 Verhaeren Gertjan	(2)	1-0	Theuerkauff Olivier	(6)

3 Van Houtte Randy	(5)	1-0	Van Laeken Jonathan	(7)
4 Proesmans Karel	(18)	1-0	De Bode Joren	(11)
5 Kazakevich Dzianis	(17)	0-1	Bourdeaud'Hui Jolan	(10)
6 Kidzinski Lukasz	(4)	1-0	Muhire Jean Michel	(14)
Bodson Bruno		Absent		
Brivet-Naudot Cyril		Absent		
Brysse Adriaan		Absent		
Demey Robbe		Absent		
Goossenaerts Tom		Absent		
Marchand Geoffrey		Absent		
Parsai Ali		Absent		

[\(Go to Top\)](#)**Round 7 (19-02-2014)**

1 Ponnet Hendrik	(1)	1-0	Proesmans Karel	(18)
2 Kidzinski Lukasz	(4)	1-1	Verhaeren Gertjan	(2)
3 Van Houtte Randy	(5)	1-0	Roos David	(3)
4 Theuerkauff Olivier	(6)	1-0	Kazakevich Dzianis	(17)
5 De Bode Joren	(11)	0-1	Bourdeaud'Hui Jolan	(10)
6 Muhire Jean Michel	(14)	0-1	Van Laeken Jonathan	(7)
Bodson Bruno		Absent		
Brivet-Naudot Cyril		Absent		
Brysse Adriaan		Absent		
Demey Robbe		Absent		
Goossenaerts Tom		Absent		
Marchand Geoffrey		Absent		
Parsai Ali		Absent		

[\(Go to Top\)](#)**American Ranking**

	Name	Rating	Pts	Perf	R1	R2	R3	R4	R5	R6	R7	Buch	M B	Prg
1	Ponnet Hendrik	2261	6.5	2423	5W +	9B +	4W +	2B +	3W =	8B +	6W +	---	---	---
2	Verhaeren Gertjan	2121	5.5	2210	12B +	3W +	8B +	1W -	5B +	4W +	9B =	30.0	---	---
3	Van Houtte Randy	1993	5.5	2172	11W +	2B -	13W +	9B +	1B =	5W +	8W +	26.0	---	---
4	Theuerkauff Olivier	1905	4.5	1970	6B +	12W +	1B -	8W =	7B +	2B -	11W +	---	---	---
5	Van Laeken Jonathan	1769	4.0	1770	1B -	10W +	6B +	11W +	2W -	3B -	19B +	25.0	---	---
6	Proesmans Karel	0	4.0	1357	4W -	7B +	5W -	13B +	19B +	10W +	1B -	23.5	---	---
7	Bourdeaud'Hui Jolan	1668	4.0	1648	8B -	6W -	19B +	12W +	4W -	11B +	10B +	18.0	---	---

8	Roos David	2111	3.5	1979	7W +	13B +	2W -	4B =	9W +	1W -	3B -	31.5	---	---
9	Kidzinski Lukasz	2052	3.5	1947	10B +	1W -	11B +	3W -	8B -	19W +	2W =	24.5	---	---
10	De Bode Joren	1552	2.0	1370	9W -	5B -	12B -	19W +	11B +	6B -	7W -	---	---	---
11	Kazakevich Dzianis	0	1.0	1266	3B -	19W +	9W -	5B -	10W -	7W -	4B -	24.0	---	---
12	Demey Robbe	1757	1.0	1624	2W -	4B -	10W +	7B -	23.5	---	---
13	Brysse Adriaan	0	1.0	697	bye	8W -	3B -	6W -	21.0	---	---
14	Parsai Ali	1758	0.0	0	24.5	17.5	---
15	Marchand Geoffrey	1168	0.0	0	24.5	17.5	---
16	Brivet-Naudot Cyril	0	0.0	0	24.5	17.5	---
17	Bodson Bruno	0	0.0	0	24.5	17.5	---
18	Goossenaerts Tom	0	0.0	0	24.5	17.5	---
19	Muhire Jean Michel	0	0.0	438	...	11B -	7W -	10B -	6W -	9B -	5W -	19.0	---	---

[Top of Page](#)

(©) FRBE 2005 PairTwo 4.14

Mercredi 12 mars 2014

Championnat Enseignement Supérieur

INFORMATIONS GENERALES :

- * **HORAIRE** : Accueil et échauffement dès 12h et compétition à partir de 14h.
- * **LIEU** : Espace Grimpe, Chaussée de Charleroi 26, 6061 Montignies sur Sambre.
- * **INFOS** : **Championnat A** : 3 voies à réaliser à partir de la 7 A et au moins une voie en tête.
Championnat B : 4-5 voies à réaliser à partir de la 5B.
Remise des prix et réception dès 18h.
Petite restauration possible sur place.
- * **PARTICIPATION** : **Organisation ouverte à tous.**
10€ pour les non membres et institutions étrangères, payable sur place.

INSCRIPTIONS :

En ligne via le lien : <http://www.aseus.be/formulaire/2194>

Clôture le jeudi 10/03/2014, 16h.

Attention, clôture anticipative possible sous réserve des disponibilités.

Le responsable sport de ton institution recevra une confirmation de ton inscription par mail.

Inscris-toi sans attendre grâce à ton smartphone et ce QR-CODE !

Infos : sebastien@arcs-evasion.be 0484/93.09.64

ArcsEvasion.be :



Résultats du Championnat FSUB d'Escalade

UCL- Espace Grimpe- Charleroi

Mercredi 12 mars 2014



CHAMPIONNAT ESCALADE

12/03/2014

Championnat A

1 - TIMMERMANS Loïc (UCLouvain) 100 pts

2 - BERTHE Sébastien (UCLouvain) 80 pts

3 - NYSENS Lucas (UCLouvain) 65 pts

4 - LOMBAERTS Jeremy (VUB) 55 pts

5 - LAMBERT Pierre Henry (ULB) 47 pts

6 - BERTHE Jonathan (UCLouvain) 43 pts

DAMES

1 - HAYEN Magali (HE Charlemagne) 100 pts

Championnat B

HOMME

1 - DECRUYENAERE Nicolas 140 pts

2 - BLONDIAU Laurent 120 pts

Dimanche 16 février 2014 Championnat Enseignement Supérieur

INFORMATIONS GENERALES :

- * **HORAIRE** : Appel des tireurs à 9h30, scratch des absents à 9h45 et start à 10h00.
- * **LIEU** : Cercle d'Escrime «Les 3 armes», Salle des sports, Athénée de Gembloux, Rue Docq 26, 5030 Gembloux.
- * **INFOS** :
Les institutions alignant 5 tireurs ou plus doivent se présenter accompagnées d'un juge arbitre.
Petite restauration possible sur place.

INSCRIPTIONS :

En ligne via le lien : <http://www.aseus.be/formulaire/2206>

Clôture le jeudi 13/02/2014, 16h.

Attention, clôture anticipative possible sous réserve des disponibilités.

Le responsable sport de ton institution recevra une confirmation de ton inscription par mail.

Inscris-toi sans attendre grâce à ton smartphone et ce QR-CODE !



Résultats du Championnat FSUB
d'escrime
Gembloux

Dimanche 16 février 2014



Classement général (ordre des rangs)

rang	nom prénom	club	nation
1	ARENS Sarah	U.GENT	BEL
2	WEYNANTS Shawnee	U.GENT	BEL
3	KUZMOVA Miroslava	U.C.L.	BEL
4	JANVIER Chloé	U.C.L.	BEL
5	NYSENS Alice	E.R.M.	BEL
6	GHILES Samantha	U.C.L.	BEL
6	HOCK Nathalie	E.R.M.	BEL
8	VAN NEREM Ségolène	U.C.L.	BEL
9	SINIMALE Kiran	U LIÈGE	BEL
10	JACQUEMIN Caroline	LEONARD VINCI	BEL
11	PETERS Hélène	E.R.M.	BEL
12	SIMON Margaux	U LIÈGE	BEL
13	MURRATH Paulina	K.U.L.	BEL
14	VAN MELE Charlotte	ST LIEVENS	BEL
15	VANDERLINDEN Mélody	HTE ECO LOUVAIN	BEL
16	LEONIS Alicia	U.L.B.	BEL
17	SCOHY Aline	U.C.L.	BEL
18	DESCAMPS Maud	ST LOUIS	BEL

Classement général (ordre des rangs)

rang	nom prénom	club	nation
1	FEROT François Xavier	HTE NAMUR	BEL
2	DUPONT Quentin	U.C.L.	BEL
3	DOMBARD Thomas	ERM	BEL
4	REGIBEAU Gaspard	U.LIÈGE	BEL
5	PARISSE Olivier	U.NAMUR	BEL
6	TAQUIN David	U.C.L.	BEL
7	BERNARD Florian	U.C.L.	BEL
8	WATTIER Franck	HTE NAMUR	BEL
9	DE WIT Wouter	ST LIEVENS	BEL
10	RICHARD Jim	U.C.L.	BEL
11	PONNET Robin	U.GENT	BEL
12	POUBLAN Olivier	U.LIÈGE	BEL
13	DEFOSSE Jérôme	U.C.L.	BEL
14	DEHEZ Jérémy	K.U.L.	BEL
15	KNOOP Christian	K.U.L.	BEL
16	TENNSTEDT Hugues	HTE LOUVAIN	BEL
17	TROMBETTA Nicolo	K.U.L.	BEL
18	BLANCHART Justin	U.LIÈGE	BEL
19	VAN VLIET Alex	K.U.L.	BEL
20	DENOISEUX Jonathan	K.U.L.	BEL
21	DAGNELIE Basile	ST LOUIS	BEL
22	DEBROUX Léonard	U.C.L.	BEL
23	CRAENEN Jérôme	ERM	BEL
24	PALADIN Pierre	U.C.L.	BEL
25	GOFFINET Karl	CHARLEMAGNE	BEL
26	NAESSENS Michael	ERM	BEL
27	ROEF Jelle	ERM	BEL
28	BAUDOT Aurélien	K.U.L.	BEL
29	SURNY Martin	U.LIÈGE	BEL
29	VIEKEVORST Michael	ERM	BEL
31	LENOM Axel	ERM	BEL
32	VAN LAER Niels	K.U.L.	BEL
33	FUKS Kevin	ERM	BEL
34	CERISE Antoine	ERM	BEL
35	LAMBRECHTS Bo	ERM	BEL
36	ANZALONE Marco	ERM	BEL

Championnat de Belgique Universitaire 2014

Fleuret dames

Gembloux, le 16 février 2014

Classement général (ordre des rangs)

rang	nom prénom	club	nation
1	GROSLAMBERT	U.L.BRUXELLES	BEL
2	SWINNE Annick	U.NAMUR	BEL
3	DE GROOTE Aur	U.L.BRUXELLES	BEL
4	LAVENNE Marie	U.LIÈGE	BEL

Championnat de Belgique universitaire 2014

Fleuret Hommes

Gembloux , le 16 février 2014

Classement général (ordre des rangs)

rang	nom prénom	club	nation
1	COLARD Martin	U.LIBRE BRUXELLES	BEL
2	DECHAMPS Benjamin	LEONARD DE VINCI	BEL
3	PRAILE Martin	F.NOTRE DAMES	BEL
4	BISSEN Edouard	U.C.LOUVAIN	BEL
5	BOGAERT Vivien	F.NOTRE DAMES	BEL
6	GALLEZ Jonathan	U.LIBRE BRUXELLES	BEL
7	MERTENS Pieter	U.GENT	BEL
8	DESCAMPS Robin	U.C.LOUVAIN	BEL
9	MALEMPRÉ Benjamin	U.LIÈGE	BEL
10	SIMON Guillaume	U.LIÈGE	BEL
11	LEMONNIER Tristan	U.LIÈGE	BEL
12	CABRERA Juan	U.LIÈGE	BEL

Championnat de Belgique Universitaire 2014

Sabre Dames

GEmbloux, le 16 février 2014

Classement général (ordre des rangs)

rang	nom prénom	club	nation
1	COOREMAN Hanne	U.GENT	BEL
2	BLOCH Manon	U.GENT	BEL
3	DE CORTIS Margaux	U.LIÈGE	BEL

Championnat de Belgique universitaire 2014

Sabre Hommes

Gembloux, le 16 février 2014

Classement général (ordre des rangs)

rang	nom prénom	club	nation
1	BREYNE Servaas	U.GENT	BEL
2	GEVAERT Vincent	U.GENT	BEL
3	COLSON François	HTE LOUVAIN	BEL
4	ERNST Uli	K.U.LEUVEN	BEL
5	BECKERS Guillaume	U.C.LOUVAIN	BEL
6	CEULEMANS Niels	U.GENT	BEL
7	DEJARNAC Marius	U.LIÈGE	BEL
8	VANNI Sébastien	U.LIÈGE	BEL

Mercredi 12 mars 2014

Championnat Enseignement Supérieur

INFORMATIONS GENERALES :

- * **HORAIRE** : Echauffement de 16h00 à 18h. Début des compétitions à 18h.
- * **LIEU** : Centre Sportif du Blocry (Salle GSA), Place des Sports 1, 1348 Louvain-la-Neuve.
- * **REGLEMENT** : Disponible via le lien suivant :
http://www.aseus.be/sites/default/files/reglement_des_championnats_ouverts_fsub_de_gymnastique.pdf
Les institutions alignant 5 gymnastes ou plus doivent être accompagnées d'un juge.
- * **TRAILER** : <https://www.facebook.com/photo.php?v=10151920434041795&set=vb.613331794&type=2&theater>
- * **INFOS** : <https://www.facebook.com/events/667007673321190/>



INSCRIPTIONS :

En ligne via le lien : <http://www.aseus.be/formulaire/3470>

Clôture le vendredi 7/03/2014, 16h.

Attention, clôture anticipative possible sous réserve des disponibilités.

Le responsable sport de ton institution recevra une confirmation de ton inscription par mail.

Inscris-toi sans attendre grâce à ton smartphone et ce QR-CODE !



Résultats du Championnat FSUB de Gymnastique

UCL- Blocry- LLN

Mercredi 12 mars 2014



UCL FEM

12/03/14 - Gymnastique Artistique Féminine par équipe

UCL fem

Rank	Nr	Participant			Max							Total		
			D/P	Note		D/P	Note	D/P	Note	D/P	Note			
1	221	MALFAIT Iris KUL F	3,8	12,100	-	0,000	12,100	4,5	12,800	7,1	14,250	5,5	14,500	53,650
			-					-	(10,0)	-	(10,0)	-	(10,0)	
2	234	GOEDLEVEN Margo KUL F	4,0	12,700	4,0	12,750	12,750	5,2	12,100	5,3	13,000	6,6	13,600	51,450
			-					-	(10,0)	-	(10,0)	-	(9,7)	
3	229	VAN ASSCHE Tine KUL F	4,0	12,400	4,0	11,600	12,400	4,7	12,050	5,9	11,400	5,6	14,200	50,050
			-					-	(10,0)	-	(10,0)	-	(10,0)	
4	226	GOEDLEVEN Liesbeth KUL F	4,0	11,100	4,0	11,400	11,400	4,6	12,300	6,3	12,800	5,9	13,400	49,900
			-					-	(10,0)	-	(10,0)	-	(10,0)	
5	272	ORTIBUS Nieke Arteveld Hogeschool	2,4	11,350	2,4	11,300	11,350	4,7	11,400	4,7	11,750	5,1	12,600	47,100
			-					-	(10,0)	-	(10,0)	-	(10,0)	
6	233	GOEDLEVEN Jolien KUL F	4,0	12,550	4,0	12,400	12,550	3,1	10,200	4,0	10,850	4,5	11,600	45,200
			-					-	(10,0)	-	(10,0)	-	(10,0)	
7	216	D'HARLINGUE Laetitia UCL F	4,0	10,250	0,0	10,000	10,250	2,3	10,450	3,4	11,150	4,5	13,100	44,950
			-					-	(10,0)	-	(10,0)	-	(10,0)	
8	218	ROMAIN Mary UCL F	3,0	10,850	3,0	10,950	10,950	1,8	7,750	4,1	11,200	5,1	13,200	43,100
			-					-	(9,0)	-	(10,0)	-	(10,0)	
9	228	GOEDLEVEN Eilen KUL F	2,4	11,200	3,0	10,050	11,200	2,4	8,700	3,6	10,850	4,1	11,800	42,550
			-					-	(10,0)	-	(10,0)	-	(10,0)	
10	210	DELSEMME Yulara ULB F	2,4	10,750	2,8	10,300	10,750	1,4	6,600	3,6	11,100	3,6	12,300	40,750
			-					-	(10,0)	-	(10,0)	-	(10,0)	
11	220	KECH Alyson UCL F	3,0	11,750	2,4	9,900	11,750	1,3	5,500	4,3	12,850	4,1	10,400	40,500
			-					-	(9,0)	-	(10,0)	-	(10,0)	
12	222	DECAESTEKER Tatjana KUL F	2,4	10,250	-	0,000	10,250	2,9	6,150	3,7	10,100	4,6	13,400	39,900
			-					-	(9,0)	-	(10,0)	-	(10,0)	
13	205	LHEUREUX Estelle UCL F	2,4	11,150	2,4	10,850	11,150	1,4	7,400	3,6	11,050	3,8	9,450	39,050
			-					-	(10,0)	-	(10,0)	-	(10,0)	
14	231	ANTHONIS Sofie KUL F	2,1	9,950	3,0	10,250	10,250	2,1	7,350	2,3	10,850	3,1	10,200	38,650
			-					-	(10,0)	-	(10,0)	-	(10,0)	
15	217	LARI CARRILLO Eleni UCL F	-	--	-	--	--	3,7	11,450	5,9	13,250	5,9	13,000	37,700
			-					-	(10,0)	-	(10,0)	-	(10,0)	
16	239	DEGRYSE Camille KUL F	3,0	10,400	3,0	10,000	10,400	1,4	7,650	1,9	9,150	2,7	10,200	37,400
			-					-	(10,0)	-	(10,0)	-	(10,0)	
17	219	EVARD Lola UCL F	2,4	10,550	2,4	9,800	10,550	1,2	4,700	3,0	10,400	2,7	10,800	36,450
			-					-	(8,0)	-	(10,0)	-	(10,0)	
18	206	BAUWENS Maryse UCL F	3,0	10,850	3,0	9,450	10,850	1,8	5,750	3,6	9,300	3,1	9,400	35,300
			-					-	(9,0)	-	(10,0)	-	(10,0)	
19	236	SJOMKÁNE Maija KUL F	2,4	10,300	-	0,000	10,300	0,9	3,550	3,0	8,000	1,9	8,900	30,750
			-					-	(7,0)	-	(10,0)	-	(10,0)	
20	207	BEAUDELLOT Clara UCL F	2,4	9,900	2,4	8,750	9,900	-	--	3,0	10,750	3,1	9,200	29,850
			-					-	(--)	-	(10,0)	-	(10,0)	
21	237	OPPEDIJK Christine KUL F	-	--	-	--	--	-	--	2,7	9,000	2,4	9,900	18,900
			-					-	(--)	-	(10,0)	-	(10,0)	
22	201	ANCION Aline HE Namur Liège Lux F	-	0,000	-	0,000	0,000	1,3	5,300	-	--	3,1	8,700	14,000
			-					-	(9,0)	-	(--)	-	(10,0)	
23	235	VAN RAEMDONCK Yani KUL F	-	--	-	--	--	-	--	1,1	6,100	1,3	7,150	13,250
			-					-	(--)	-	(9,0)	-	(10,0)	

Résultats concours général

24	203	IBRAGIMOVA Emilia Vinci F	- --	- --	--	- --	4,2 11,350	- --	11,350
			-	-		- (-)	- (10,0)	- (-)	
25	204	BARBÉ Caroline UCL F	- --	- --	--	3,0 8,150	- --	- --	8,150
			-	-		- (10,0)	- (-)	- (-)	

Résultats Poutre

UCL FEM

12/03/14 - Gymnastique Artistique Féminine par équipe

UCL fem

Cl	Nr	Participant	Club	D	E	P	Total
1	221	MALFAIT Iris	KUL F	7,1	7,150	-	14,250
2	217	LARI CARRILLO Eleni	UCL F	5,9	7,350	-	13,250
3	234	GOEDLEVEN Margo	KUL F	5,3	7,700	-	13,000
4	220	KECH Alyson	UCL F	4,3	8,550	-	12,850
5	226	GOEDLEVEN Liesbeth	KUL F	6,3	6,500	-	12,800
6	272	ORTIBUS Nieke	Arteveld Hogeschool	4,7	7,050	-	11,750
7	229	VAN ASSCHE Tine	KUL F	5,9	5,500	-	11,400
8	203	IBRAGIMOVA Emilia	Vinci F	4,2	7,150	-	11,350
9	218	ROMAIN Mary	UCL F	4,1	7,100	-	11,200
10	216	D'HARLINGUE Laetitia	UCL F	3,4	7,750	-	11,150
11	210	DELSEMME Yulara	ULB F	3,6	7,500	-	11,100
12	205	LHEUREUX Estelle	UCL F	3,6	7,450	-	11,050
13	228	GOEDLEVEN Ellen	KUL F	3,6	7,250	-	10,850
13	231	ANTHONIS Sofie	KUL F	2,3	8,550	-	10,850
13	233	GOEDLEVEN Jolien	KUL F	4,0	6,850	-	10,850
16	207	BEAUDELLOT Clara	UCL F	3,0	7,750	-	10,750
17	219	EVRRARD Lola	UCL F	3,0	7,400	-	10,400
18	222	DECAESTEKER Tatjana	KUL F	3,7	6,400	-	10,100
19	206	BAUWENS Maryse	UCL F	3,6	5,700	-	9,300
20	239	DEGRYSE Camille	KUL F	1,9	7,250	-	9,150
21	237	OPPEDIJK Christine	KUL F	2,7	6,300	-	9,000
22	236	SJOMKÁNE Maija	KUL F	3,0	5,000	-	8,000
23	235	VAN RAEMDONCK Yani	KUL F	1,1	5,000	-	6,100

Résultats Saut

UCL FEM

12/03/14 - Gymnastique Artistique Féminine par équipe

UCL fem

Cl	Nr	Participant	Club	D	E	P	Total
1	234	GOEDLEVEN Margo	KUL F	4,0	8,700	-	12,750
2	233	GOEDLEVEN Jolien	KUL F	4,0	8,550	-	12,550
3	229	VAN ASSCHE Tine	KUL F	4,0	8,400	-	12,400
4	221	MALFAIT Iris	KUL F	3,8	8,300	-	12,100
5	220	KECH Alyson	UCL F	3,0	8,750	-	11,750
6	226	GOEDLEVEN Liesbeth	KUL F	4,0	7,100	-	11,400
7	272	ORTIBUS Nieke	Arteveld Hogeschool	2,4	8,950	-	11,350
8	228	GOEDLEVEN Ellen	KUL F	2,4	8,800	-	11,200
9	205	LHEUREUX Estelle	UCL F	2,4	8,750	-	11,150
10	218	ROMAIN Mary	UCL F	3,0	7,850	-	10,950
11	206	BAUWENS Maryse	UCL F	3,0	7,850	-	10,850
12	210	DELSEMME Yulara	ULB F	2,4	8,350	-	10,750
13	219	EVRAUD Lola	UCL F	2,4	8,150	-	10,550
14	239	DEGRYSE Camille	KUL F	3,0	7,400	-	10,400
15	236	SJOMKÅNE Maija	KUL F	2,4	7,900	-	10,300
16	216	D'HARLINGUE Laetitia	UCL F	4,0	6,250	-	10,250
16	222	DECAESTEKER Tatjana	KUL F	2,4	7,850	-	10,250
16	231	ANTHONIS Sofie	KUL F	2,1	7,850	-	10,250
19	207	BEAUDELLOT Clara	UCL F	2,4	7,500	-	9,900
20	201	ANCION Aline	HE Namur Liège Lux F	-	10,000	-	0,000

UCL FEM

12/03/14 - Gymnastique Artistique Féminine par équipe

UCL fem

Cl	Nr	Participant	Club	D	E	P	Total
1	221	MALFAIT Iris	KUL F	5,5	9,000	-	14,500
2	229	VAN ASSCHE Tine	KUL F	5,6	8,600	-	14,200
3	234	GOEDLEVEN Margo	KUL F	6,6	7,000	-	13,600
4	222	DECAESTEKER Tatjana	KUL F	4,6	8,800	-	13,400
4	226	GOEDLEVEN Liesbeth	KUL F	5,9	7,500	-	13,400
6	218	ROMAIN Mary	UCL F	5,1	8,100	-	13,200
7	216	D'HARLINGUE Laetitia	UCL F	4,5	8,600	-	13,100
8	217	LARI CARRILLO Eleni	UCL F	5,9	7,100	-	13,000
9	272	ORTIBUS Nieke	Arteveld Hogeschool	5,1	7,500	-	12,600
10	210	DELSEMME Yulara	ULB F	3,6	8,700	-	12,300
11	228	GOEDLEVEN Ellen	KUL F	4,1	7,700	-	11,800
12	233	GOEDLEVEN Jolien	KUL F	4,5	7,100	-	11,600
13	219	EVRRARD Lola	UCL F	2,7	8,100	-	10,800
14	220	KECH Alyson	UCL F	4,1	6,300	-	10,400
15	231	ANTHONIS Sofie	KUL F	3,1	7,100	-	10,200
15	239	DEGRYSE Camille	KUL F	2,7	7,500	-	10,200
17	237	OPPEDIJK Christine	KUL F	2,4	7,500	-	9,900
18	205	LHEUREUX Estelle	UCL F	3,8	5,650	-	9,450
19	206	BAUWENS Maryse	UCL F	3,1	6,300	-	9,400
20	207	BEAUDELLOT Clara	UCL F	3,1	6,100	-	9,200
21	236	SJOMKÁNE Maija	KUL F	1,9	7,000	-	8,900
22	201	ANCION Aline	HE Namur Liège Lux F	3,1	5,600	-	8,700
23	235	VAN RAEMDONCK Yani	KUL F	1,3	5,850	-	7,150

Résultats Barres

UCL FEM

12/03/14 - Gymnastique Artistique Féminine par équipe

UCL fem

Cl	Nr	Participant	Club	D	E	P	Total
1	221	MALFAIT Iris	KUL F	4,5	8,300	-	12,800
2	226	GOEDLEVEN Liesbeth	KUL F	4,6	7,700	-	12,300
3	234	GOEDLEVEN Margo	KUL F	5,2	6,900	-	12,100
4	229	VAN ASSCHE Tine	KUL F	4,7	7,350	-	12,050
5	217	LARI CARRILLO Eleni	UCL F	3,7	7,750	-	11,450
6	272	ORTIBUS Nieke	Arteveld Hogeschool	4,7	6,700	-	11,400
7	216	D'HARLINGUE Laetitia	UCL F	2,3	8,150	-	10,450
8	233	GOEDLEVEN Jolien	KUL F	3,1	7,100	-	10,200
9	228	GOEDLEVEN Ellen	KUL F	2,4	6,300	-	8,700
10	204	BARBÉ Caroline	UCL F	3,0	5,150	-	8,150
11	218	ROMAIN Mary	UCL F	1,8	5,950	-	7,750
12	239	DEGRYSE Camille	KUL F	1,4	6,250	-	7,650
13	205	LHEUREUX Estelle	UCL F	1,4	6,000	-	7,400
14	231	ANTHONIS Sofie	KUL F	2,1	5,250	-	7,350
15	210	DELSEMME Yulara	ULB F	1,4	5,200	-	6,600
16	222	DECAESTEKER Tatjana	KUL F	2,9	3,250	-	6,150
17	206	BAUWENS Maryse	UCL F	1,8	3,950	-	5,750
18	220	KECH Alyson	UCL F	1,3	4,200	-	5,500
19	201	ANCION Aline	HE Namur Liège Lux F	1,3	4,000	-	5,300
20	219	EVARD Lola	UCL F	1,2	3,500	-	4,700
21	236	SJOMKĀNE Maija	KUL F	0,9	2,650	-	3,550





UCL FEM

12/03/14 - Gymnastique Artistique Féminine par équipe

UCL fem





1 KUL F 1

KUL F

Nr	Participant											Total
		D/P	Note	D/P	Note	D/P	Note	D/P	Note			
221	MALFAIT Iris	-	0,000	12,100	4,5	12,80	7,1	14,25	5,5	14,50		
		-			-		-		-			
222	DECAESTEKER Tatjana	-	0,000	10,250	2,9	6,150	3,7	10,10	4,6	13,40		
		-			-		-		-			
226	GOEDLEVEN Liesbeth	4,0	11,40	11,400	4,6	12,30	6,3	12,80	5,9	13,40		
		-			-		-		-			
228	GOEDLEVEN Ellen	3,0	10,05	11,200	2,4	8,700	3,6	10,85	4,1	11,80		
		-			-		-		-			
				44,950		39,950		48,000		53,100	186,000	





2 KUL F 2

KUL F

Nr	Participant											Total
		D/P	Note	D/P	Note	D/P	Note	D/P	Note			
229	VAN ASSCHE Tine	4,0	11,60	12,400	4,7	12,05	5,9	11,40	5,6	14,20		
		-			-		-		-			
231	ANTHONIS Sofie	3,0	10,25	10,250	2,1	7,350	2,3	10,85	3,1	10,20		
		-			-		-		-			
233	GOEDLEVEN Jolien	4,0	12,40	12,550	3,1	10,20	4,0	10,85	4,5	11,60		
		-			-		-		-			
234	GOEDLEVEN Margo	4,0	12,75	12,750	5,2	12,10	5,3	13,00	6,6	13,60		
		-			-		-		-			
				47,950		41,700		46,100		49,600	185,350	





3 UCL 1

UCL F





Nr	Participant											Total
		D/P	Note	D/P	Note	D/P	Note	D/P	Note			
216	D'HARLINGUE Laetitia	0,0	10,00	10,250	2,3	10,45	3,4	11,15	4,5	13,10		
		-			-		-		-			
217	LARI CARRILLO Eleni				3,7	11,45	5,9	13,25	5,9	13,00		
					-		-		-			
218	ROMAIN Mary	3,0	10,95	10,950	1,8	7,750	4,1	11,20	5,1	13,20		
		-			-		-		-			
219	EVARD Lola	2,4	9,800	10,550	1,2	4,700	3,0	10,40	2,7	10,80		
		-			-		-		-			
220	KECH Alyson	2,4	9,900	11,750	1,3	5,500	4,3	12,85	4,1	10,40		
		-			-		-		-			
216	D'HARLINGUE Laetitia	0,0	10,00	10,250	2,3	10,45	3,4	11,15	4,5	13,10		
		-			-		-		-			

217	LARI CARRILLO Eleni			3,7 11,45	5,9 13,25	5,9 13,00	
218	ROMAIN Mary	3,0 10,95	10,950	1,8 7,750	4,1 11,20	5,1 13,20	
219	EVARD Lola	2,4 9,800	10,550	1,2 4,700	3,0 10,40	2,7 10,80	
220	KECH Alyson	2,4 9,900	11,750	1,3 5,500	4,3 12,85	4,1 10,40	
				43,500	35,150	48,450	50,100 177,200





5 UCL 2
UCL F

Nr	Participant									Total
		D/P	Note	D/P	Note	D/P	Note	D/P	Note	
204	BARBÉ Caroline			3,0 8,150						
205	LHEUREUX Estelle	2,4 10,85	11,150	1,4 7,400	3,6 11,05	3,8 9,450				
206	BAUWENS Maryse	3,0 9,450	10,850	1,8 5,750	3,6 9,300	3,1 9,400				
207	BEAUDELLOT Clara	2,4 8,750	9,900		3,0 10,75	3,1 9,200				
				31,900	21,300	31,100	28,050	112,350		

6 KUL F 3
KUL F

Nr	Participant									Total
		D/P	Note	D/P	Note	D/P	Note	D/P	Note	
235	VAN RAEMDONCK Yani				1,1 6,100	1,3 7,150				
236	SJOMKĀNE Maija	- 0,000	10,300	0,9 3,550	3,0 8,000	1,9 8,900				
237	OPPEDIJK Christine				2,7 9,000	2,4 9,900				
239	DEGRYSE Camille	3,0 10,00	10,400	1,4 7,650	1,9 9,150	2,7 10,20				
				20,700	11,200	32,250	36,150	100,300		





7 ULB 1
ULB F

Nr	Participant									Total
		D/P	Note	D/P	Note	D/P	Note	D/P	Note	
210	DELSEMME Yulara	2,8 10,30	10,750	1,4 6,600	3,6 11,10	3,6 12,30				
210	DELSEMME Yulara	2,8 10,30	10,750	1,4 6,600	3,6 11,10	3,6 12,30				
				10,750	6,600	11,100	12,300	40,750		

UCL Hom

- Gymnastique Artistique Masculine par équipe

UCL Hom

Clas	Nr	Participant/Club											Total				
			D/P	Note	D/P	Note	D/P	Note	D/P	Note	D/P	Note					
1	267	SPOELTRA Gawein KUL H	9,5	18,550	8,5	16,000	7,2	13,700	3,6	12,400	-	0,000	7,6	13,700	7,7	13,700	88,050
2	239	LORQUET Frédéric HE Liège H	6,2	13,500	8,5	16,200	7,5	14,850	2,4	11,400	-	0,000	6,9	14,400	6,5	14,300	84,650
3	248	ROMAZZOTTI Quentin ULB H	6,8	15,500	5,6	14,000	4,6	13,200	2,8	11,750	-	0,000	5,3	12,700	4,8	12,550	79,700
4	260	TERRANA Thomas UCL H	7,3	15,550	4,4	10,500	6,8	14,500	2,8	11,600	-	0,000	5,9	14,500	4,8	12,500	79,150
5	240	HANEGREEFS Philip ARTEVELDE HS	7,9	15,700	5,5	12,200	4,3	12,950	2,8	11,700	-	0,000	6,1	15,000	4,5	11,000	78,550
6	263	AUDOORE Vincent KUL H	6,1	14,450	4,7	11,200	4,8	12,500	2,8	11,700	-	0,000	6,1	13,900	5,1	13,850	77,600
7	241	NULLENS Kevin HE Liège H	6,4	14,950	5,6	13,000	4,3	11,350	2,8	12,300	-	0,000	5,0	11,900	5,1	12,350	75,850
8	261	AUDOORE Laurens KUL H	5,7	13,050	4,7	13,100	3,7	11,950	2,0	11,450	-	0,000	5,0	13,500	4,5	12,450	75,500
9	264	CALLENS Mickael KUL H	6,2	14,750	5,0	10,900	4,5	12,250	2,8	11,950	-	0,000	5,0	12,700	3,7	11,050	73,600
10	258	DETROZ Julien UCL H	5,8	13,250	5,3	10,200	6,2	12,300	2,0	11,450	-	0,000	4,4	12,400	2,5	8,550	68,150
11	259	RONDEAU Alexis UCL H	3,8	12,200	3,6	10,700	4,0	11,150	2,4	11,500	-	0,000	4,1	11,000	2,5	8,950	65,500
12	256	DELMOTTE Arnaud UCL H	4,1	11,800	4,4	12,100	5,4	11,250	2,0	10,750	-	0,000	4,7	12,000	2,2	7,400	65,300
13	268	DENISSEN Stijn KUL H	3,3	11,550	2,2	5,200	3,3	10,950	2,0	10,550	-	0,000	3,5	8,500	0,8	8,050	54,800
14	253	DE WOLF Bernard ULB H	2,8	10,750	1,6	4,300	2,8	8,850	2,0	10,750	-	0,000	3,8	10,100	1,4	8,400	53,150
15	255	CONIGLIO Florian UCL H	-	--	-	--	4,3	11,600	2,0	11,350	-	0,000	4,7	12,700	2,3	6,050	41,700
16	247	MALASSAGNE Vincent ULB H	-	--	5,3	13,900	4,0	13,150	-	--	-	--	4,4	14,100	-	--	41,150
17	270	RUJMEN Mathias KUL H	4,1	11,450	2,8	7,800	1,4	5,550	2,4	11,250	-	0,000	-	--	-	--	36,050
18	271	RUMMENS Joris KUL H	4,5	12,250	-	--	-	--	2,4	11,200	-	0,000	3,3	7,200	-	--	30,650
19	251	GOOSSENS Matthieu ULB H	4,2	11,400	-	--	-	--	2,0	10,800	-	0,000	-	--	-	--	22,200
20	243	BAQUET Jolan He Namur Liège Lux H	-	--	-	--	2,8	6,850	3,0	11,850	-	0,000	-	--	-	--	18,700
21	249	DATOUSSAID Mehdi ULB H	-	--	0,8	3,800	-	--	-	--	-	--	-	--	2,7	9,600	13,400
22	246	CHARLES Diégo ULB H	-	--	-	--	-	--	-	--	-	--	-	--	-	--	0,000
22	266	VAN AKEN Nick KUL H	-	--	-	--	-	--	-	--	-	--	-	--	-	--	0,000

UCL Hom

- Gymnastique Artistique Masculine par équipe

UCL Hom

Cla	Nr	Participant	Club	D	E1	E2	E3	E4	E5	E6	E	P	Total
1	239	LORQUET Frédéric	HE Liège H	7,5	8,0	6,7	-	-	-	-	7,350	-	14,850
2	260	TERRANA Thomas	UCL H	6,8	8,0	7,4	-	-	-	-	7,700	-	14,500
3	267	SPOELTRA Gawein	KUL H	7,2	6,4	6,6	-	-	-	-	6,500	-	13,700
4	248	ROMAZZOTTI Quentin	ULB H	4,6	8,8	8,4	-	-	-	-	8,600	-	13,200
5	247	MALASSAGNE Vincent	ULB H	4,0	9,1	9,2	-	-	-	-	9,150	-	13,150
6	240	HANEGREEFS Philip	ARTEVELDE HS	4,3	8,6	8,7	-	-	-	-	8,650	-	12,950
7	263	AUDOORE Vincent	KUL H	4,8	7,5	7,9	-	-	-	-	7,700	-	12,500
8	258	DETROZ Julien	UCL H	6,2	6,2	6,0	-	-	-	-	6,100	-	12,300
9	264	CALLENS Mickael	KUL H	4,5	8,2	7,3	-	-	-	-	7,750	-	12,250
10	261	AUDOORE Laurens	KUL H	3,7	8,5	8,0	-	-	-	-	8,250	-	11,950
11	255	CONIGLIO Florian	UCL H	4,3	7,6	7,0	-	-	-	-	7,300	-	11,600
12	241	NULLENS Kevin	HE Liège H	4,3	7,0	7,1	-	-	-	-	7,050	-	11,350
13	256	DELMOTTE Arnaud	UCL H	5,4	5,5	6,2	-	-	-	-	5,850	-	11,250
14	259	RONDEAU Alexis	UCL H	4,0	7,0	7,3	-	-	-	-	7,150	-	11,150
15	268	DENISSEN Stijn	KUL H	3,3	7,6	7,7	-	-	-	-	7,650	-	10,950
16	253	DE WOLF Bernard	ULB H	2,8	5,8	6,3	-	-	-	-	6,050	-	8,850
17	243	BAQUET Jolan	He Namur Liège Lux H	2,8	4,9	3,2	-	-	-	-	4,050	-	6,850
18	270	RUJMEN Mathias	KUL H	1,4	4,0	4,3	-	-	-	-	4,150	-	5,550

UCL Hom

- Gymnastique Artistique Masculine par équipe

UCL Hom

Cla	Nr	Participant	Club	D	E1	E2	E3	E4	E5	E6	E	P	Total
1	239	LORQUET Frédéric	HE Liège H	8,5	7,7	8,0	7,7	-	-	-	7,700	-	16,200
2	267	SPOELTRA Gawein	KUL H	8,5	8,0	7,5	7,4	-	-	-	7,500	-	16,000
3	248	ROMAZZOTTI Quentin	ULB H	5,6	8,5	8,4	8,1	-	-	-	8,400	-	14,000
4	247	MALASSAGNE Vincent	ULB H	5,3	8,4	8,8	8,6	-	-	-	8,600	-	13,900
5	261	AUDOORE Laurens	KUL H	4,7	8,4	8,3	8,7	-	-	-	8,400	-	13,100
6	241	NULLENS Kevin	HE Liège H	5,6	7,0	7,4	7,6	-	-	-	7,400	-	13,000
7	240	HANEGREEFS Philip	ARTEVELDE HS	5,5	6,5	6,7	7,1	-	-	-	6,700	-	12,200
8	256	DELMOTTE Arnaud	UCL H	4,4	7,5	7,7	7,8	-	-	-	7,700	-	12,100
9	263	AUDOORE Vincent	KUL H	4,7	6,5	6,6	6,4	-	-	-	6,500	-	11,200
10	264	CALLENS Mickael	KUL H	5,0	5,7	6,1	5,9	-	-	-	5,900	-	10,900
11	259	RONDEAU Alexis	UCL H	3,6	6,7	7,2	7,1	-	-	-	7,100	-	10,700
12	260	TERRANA Thomas	UCL H	4,4	5,8	6,1	6,2	-	-	-	6,100	-	10,500
13	258	DETROZ Julien	UCL H	5,3	4,5	5,1	4,9	-	-	-	4,900	-	10,200
14	270	RUJMEN Mathias	KUL H	2,8	5,0	4,8	5,2	-	-	-	5,000	-	7,800
15	268	DENISSEN Stijn	KUL H	2,2	2,6	3,0	3,1	-	-	-	3,000	-	5,200
16	253	DE WOLF Bernard	ULB H	1,6	2,7	2,4	2,7	-	-	-	2,700	-	4,300
17	249	DATOUSSAID Mehdi	ULB H	0,8	3,0	3,0	3,0	-	-	-	3,000	-	3,800

Résultats Barres

UCL Hom

- Gymnastique Artistique Masculine par équipe

UCL Hom

Cl	Nr	Participant	Club	D	E1	E2	E3	E4	E5	E6	E	P	Total
1	240	HANEGREEFS Philip	ARTEVELDE HS	6,1	9,0	8,9	8,9	-	-	-	8,900	-	15,000
2	260	TERRANA Thomas	UCL H	5,9	8,6	8,4	8,6	-	-	-	8,600	-	14,500
3	239	LORQUET Frédéric	HE Liège H	6,9	7,1	7,7	7,5	-	-	-	7,500	-	14,400
4	247	MALASSAGNE Vincent	ULB H	4,4	9,7	9,8	9,7	-	-	-	9,700	-	14,100
5	263	AUDOORE Vincent	KUL H	6,1	7,9	7,8	7,5	-	-	-	7,800	-	13,900
6	267	SPOELTRA Gawein	KUL H	7,6	6,1	5,9	6,8	-	-	-	6,100	-	13,700
7	261	AUDOORE Laurens	KUL H	5,0	8,3	8,5	8,6	-	-	-	8,500	-	13,500
8	248	ROMAZZOTTI Quentin	ULB H	5,3	7,3	7,4	7,5	-	-	-	7,400	-	12,700
8	255	CONIGLIO Florian	UCL H	4,7	7,9	8,0	8,0	-	-	-	8,000	-	12,700
8	264	CALLENS Mickael	KUL H	5,0	7,5	7,7	8,0	-	-	-	7,700	-	12,700
11	258	DETROZ Julien	UCL H	4,4	8,3	8,0	7,8	-	-	-	8,000	-	12,400
12	256	DELMOTTE Arnaud	UCL H	4,7	7,3	7,0	7,4	-	-	-	7,300	-	12,000
13	241	NULLENS Kevin	HE Liège H	5,0	6,9	6,7	7,1	-	-	-	6,900	-	11,900
14	259	RONDEAU Alexis	UCL H	4,1	7,1	6,7	6,9	-	-	-	6,900	-	11,000
15	253	DE WOLF Bernard	ULB H	3,8	6,3	6,0	6,3	-	-	-	6,300	-	10,100
16	268	DENISSEN Stijn	KUL H	3,5	5,0	4,6	5,1	-	-	-	5,000	-	8,500
17	271	RUMMENS Joris	KUL H	3,3	3,5	3,9	4,5	-	-	-	3,900	-	7,200

UCL Hom

- Gymnastique Artistique Masculine par équipe

UCL Hom

Cl	Nr	Participant	Club	D	E1	E2	E3	E4	E5	E6	E	P	Total
1	239	LORQUET Frédéric	HE Liège H	6,5	8,0	7,6	-	-	-	-	7,800	-	14,300
2	263	AUDOORE Vincent	KUL H	5,1	8,8	8,7	-	-	-	-	8,750	-	13,850
3	267	SPOELTRA Gawein	KUL H	7,7	6,3	5,7	-	-	-	-	6,000	-	13,700
4	248	ROMAZZOTTI Quentin	ULB H	4,8	8,0	7,5	-	-	-	-	7,750	-	12,550
5	260	TERRANA Thomas	UCL H	4,8	7,8	7,6	-	-	-	-	7,700	-	12,500
6	261	AUDOORE Laurens	KUL H	4,5	7,7	8,2	-	-	-	-	7,950	-	12,450
7	241	NULLENS Kevin	HE Liège H	5,1	7,5	7,0	-	-	-	-	7,250	-	12,350
8	264	CALLENS Mickael	KUL H	3,7	7,7	7,0	-	-	-	-	7,350	-	11,050
9	240	HANEGREEFS Philip	ARTEVELDE HS	4,5	6,0	7,0	-	-	-	-	6,500	-	11,000
10	249	DATOUSSAID Mehdi	ULB H	2,7	6,7	7,1	-	-	-	-	6,900	-	9,600
11	259	RONDEAU Alexis	UCL H	2,5	6,4	6,5	-	-	-	-	6,450	-	8,950
12	258	DETROZ Julien	UCL H	2,5	6,0	6,1	-	-	-	-	6,050	-	8,550
13	253	DE WOLF Bernard	ULB H	1,4	6,5	7,5	-	-	-	-	7,000	-	8,400
14	268	DENISSEN Stijn	KUL H	0,8	7,5	7,0	-	-	-	-	7,250	-	8,050
15	256	DELMOTTE Arnaud	UCL H	2,2	4,9	5,5	-	-	-	-	5,200	-	7,400
16	255	CONIGLIO Florian	UCL H	2,3	4,0	3,5	-	-	-	-	3,750	-	6,050

Résultats Saut

UCL Hom

- Gymnastique Artistique Masculine par équipe

UCL Hom

Cla	Nr	Participant	Club	D	E1	E2	E3	E4	E5	E6	E	P	Total
1	267	SPOELTRA Gawein	KUL H	3,6	8,7	8,9	-	-	-	-	8,800	-	12,400
2	241	NULLENS Kevin	HE Liège H	2,8	9,5	9,5	-	-	-	-	9,500	-	12,300
3	264	CALLENS Mickael	KUL H	2,8	9,3	9,0	-	-	-	-	9,150	-	11,950
4	243	BAQUET Jolan	He Namur Liège Lux H	3,0	8,8	8,9	-	-	-	-	8,850	-	11,850
5	248	ROMAZZOTTI Quentin	ULB H	2,8	9,0	8,9	-	-	-	-	8,950	-	11,750
6	240	HANEGREEFS Philip	ARTEVELDE HS	2,8	8,8	9,0	-	-	-	-	8,900	-	11,700
6	263	AUDOORE Vincent	KUL H	2,8	9,0	8,8	-	-	-	-	8,900	-	11,700
8	260	TERRANA Thomas	UCL H	2,8	8,8	8,8	-	-	-	-	8,800	-	11,600
9	259	RONDEAU Alexis	UCL H	2,4	9,1	9,1	-	-	-	-	9,100	-	11,500
10	258	DETROZ Julien	UCL H	2,0	9,4	9,5	-	-	-	-	9,450	-	11,450
10	261	AUDOORE Laurens	KUL H	2,0	9,4	9,5	-	-	-	-	9,450	-	11,450
12	239	LORQUET Frédéric	HE Liège H	2,4	9,1	8,9	-	-	-	-	9,000	-	11,400
13	255	CONIGLIO Florian	UCL H	2,0	9,3	9,4	-	-	-	-	9,350	-	11,350
14	270	RUJMEN Mathias	KUL H	2,4	9,0	8,7	-	-	-	-	8,850	-	11,250
15	271	RUMMENS Joris	KUL H	2,4	8,7	8,9	-	-	-	-	8,800	-	11,200
16	251	GOOSSENS Matthieu	ULB H	2,0	8,8	8,8	-	-	-	-	8,800	-	10,800
17	253	DE WOLF Bernard	ULB H	2,0	8,6	8,9	-	-	-	-	8,750	-	10,750
17	256	DELMOTTE Arnaud	UCL H	2,0	8,9	8,6	-	-	-	-	8,750	-	10,750
19	268	DENISSEN Stijn	KUL H	2,0	8,7	8,4	-	-	-	-	8,550	-	10,550

UCL Hom





- *Gymnastique Artistique Masculine par équipe*

UCL Hom





Cla	Nr	Participant	Club	D	E1	E2	E3	E4	E5	E6	E	P	Total
1	267	SPOELTRA Gawein	KUL H	9,5	9,3	8,8	-	-	-	-	9,050	-	18,550
2	240	HANEGREEFS Philip	ARTEVELDE HS	7,9	7,8	7,8	-	-	-	-	7,800	-	15,700
3	260	TERRANA Thomas	UCL H	7,3	8,1	8,4	-	-	-	-	8,250	-	15,550
4	248	ROMAZZOTTI Quentin	ULB H	6,8	8,6	8,8	-	-	-	-	8,700	-	15,500
5	241	NULLENS Kevin	HE Liège H	6,4	8,5	8,6	-	-	-	-	8,550	-	14,950
6	264	CALLENS Mickael	KUL H	6,2	8,7	8,4	-	-	-	-	8,550	-	14,750
7	263	AUDOORE Vincent	KUL H	6,1	8,3	8,4	-	-	-	-	8,350	-	14,450
8	239	LORQUET Frédéric	HE Liège H	6,2	7,4	7,2	-	-	-	-	7,300	-	13,500
9	258	DETROZ Julien	UCL H	5,8	7,3	7,6	-	-	-	-	7,450	-	13,250
10	261	AUDOORE Laurens	KUL H	5,7	7,4	7,3	-	-	-	-	7,350	-	13,050
11	271	RUMMENS Joris	KUL H	4,5	8,1	7,4	-	-	-	-	7,750	-	12,250
12	259	RONDEAU Alexis	UCL H	3,8	8,3	8,5	-	-	-	-	8,400	-	12,200
13	256	DELMOTTE Arnaud	UCL H	4,1	7,8	7,6	-	-	-	-	7,700	-	11,800
14	268	DENISSEN Stijn	KUL H	3,3	8,3	8,2	-	-	-	-	8,250	-	11,550
15	270	RUJMEN Mathias	KUL H	4,1	7,6	7,1	-	-	-	-	7,350	-	11,450
16	251	GOOSSENS Matthieu	ULB H	4,2	7,2	7,2	-	-	-	-	7,200	-	11,400
17	253	DE WOLF Bernard	ULB H	2,8	8,1	7,8	-	-	-	-	7,950	-	10,750

UCL Hom





1 KUL 1
KUL H

Nr	Participant											Total		
		D/P	Note	D/P	Note	D/P	Note	D/P	Note	D/P	Note			
261	AUDOORE Laurens KUL H	5,7	13,05	4,7	13,10	3,7	11,95	2,0	11,45	5,0	13,50	4,5	12,45	
263	AUDOORE Vincent KUL H	6,1	14,45	4,7	11,20	4,8	12,50	2,8	11,70	6,1	13,90	5,1	13,85	
264	CALLENS Mickael KUL H	6,2	14,75	5,0	10,90	4,5	12,25	2,8	11,95	5,0	12,70	3,7	11,05	
266	VAN AKEN Nick KUL H													
267	SPOELTRA Gawein KUL H	9,5	18,55	8,5	16,00	7,2	13,70	3,6	12,40	7,6	13,70	7,7	13,70	
		47,750		40,300		38,450		36,050		41,100		40,000		243,650

2 UCL H
UCL H







Nr	Participant											Total		
		D/P	Note	D/P	Note	D/P	Note	D/P	Note	D/P	Note			
255	CONIGLIO Florian UCL H					4,3	11,60	2,0	11,35	4,7	12,70	2,3	6,050	
256	DELMOTTE Arnaud UCL H	4,1	11,80	4,4	12,10	5,4	11,25	2,0	10,75	4,7	12,00	2,2	7,400	
258	DETROZ Julien UCL H	5,8	13,25	5,3	10,20	6,2	12,30	2,0	11,45	4,4	12,40	2,5	8,550	
259	RONDEAU Alexis UCL H	3,8	12,20	3,6	10,70	4,0	11,15	2,4	11,50	4,1	11,00	2,5	8,950	
260	TERRANA Thomas UCL H	7,3	15,55	4,4	10,50	6,8	14,50	2,8	11,60	5,9	14,50	4,8	12,50	
		41,000		33,300		38,400		34,550		39,600		30,000		216,850

3 ULB
ULB H







Nr	Participant											Total		
		D/P	Note	D/P	Note	D/P	Note	D/P	Note	D/P	Note			
246	CHARLES Diégo ULB H													
247	MALASSAGNE Vincent ULB H			5,3	13,90	4,0	13,15			4,4	14,10			
248	ROMAZZOTTI Quentin ULB H	6,8	15,50	5,6	14,00	4,6	13,20	2,8	11,75	5,3	12,70	4,8	12,55	
249	DATOUSSAID Mehdi ULB H			0,8	3,800						2,7	9,600		
251	GOOSSENS Matthieu ULB H	4,2	11,40					2,0	10,80					
253	DE WOLF Bernard ULB H	2,8	10,75	1,6	4,300	2,8	8,850	2,0	10,75	3,8	10,10	1,4	8,400	

37,650 32,200 35,200 33,300 36,900 30,550 205,800

4 KUL 2
KUL H

Nr	Participant													Total
		D/P	Note	D/P	Note	D/P	Note	D/P	Note	D/P	Note	D/P	Note	
268	DENISSEN Stijn KUL H	3,3	11,55	2,2	5,200	3,3	10,95	2,0	10,55	3,5	8,500	0,8	8,050	
		-	-	-	-	-	-	0,0	0,0	0,0	0,0	0,0	0,0	
270	RUJMEN Mathias KUL H	4,1	11,45	2,8	7,800	1,4	5,550	2,4	11,25					
		-	-	-	-	-	-	0,0	0,0					
271	RUMMENS Joris KUL H	4,5	12,25					2,4	11,20	3,3	7,200			
		-	-					0,0	0,0	0,0	0,0			
		35,250		13,000		16,500		33,000		15,700		8,050		121,500

5 HE Nam/li/Lux
He Namur Liège Lux H

Nr	Participant													Total
		D/P	Note	D/P	Note	D/P	Note	D/P	Note	D/P	Note	D/P	Note	
243	BAQUET Jolan He Namur Liège Lux H					2,8	6,850	3,0	11,85					
						-	-	0,0	0,0					
		0,000		0,000		6,850		11,850		0,000		0,000		18,700

Mercredi 2 avril 2014

Championnat Enseignement Supérieur

INFORMATIONS GENERALES :

- * **HORAIRE** : Pesée de 12h00 à 13h. Début des compétitions à 13h30.
- * **LIEU** : Industrielaan 2, 8820 Torhout.
- * **INFOS** : Les catégories lourdes commencent les premières (D & H).
Compétition sur 3 tatamis.

INSCRIPTIONS :

En ligne via le lien : <http://www.aseus.be/formulaire/400>

Clôture le lundi 31/03/2014, 16h.

Attention, clôture anticipative possible sous réserve des disponibilités.

Le responsable sport de ton institution recevra une confirmation de ton inscription par mail.

Inscris-toi sans attendre grâce à ton smartphone et ce QR-CODE !

Avec le soutien de :

Sport & muziecafé Extra Time,
Sporthal Ichtegem



Résultats du Championnat FSUB de Judo Individuel

Torhout- VIVES-Mercredi 2 avril 2014





Dames U21+

Gewicht:	Plaats	Naam	Club
-48 kg	Aantal Deelnemers: 2		
	1	Audiens Evelyne	Universiteit Antwerpen
	2	Corvelyn Marlies	Katholieke Universiteit Leuven
-52 kg	Aantal Deelnemers: 2		
	1	Declerck Rani	Katholieke Hogeschool Vives
	2	Delanghe Karen	Artevelde Hogeschool
-57 kg	Aantal Deelnemers: 4		
	1	Denoo Lotte	Artevelde Hogeschool
	2	Arnórsdóttir Ásta Lovísa	Université Libre de Bruxelles
	3	Delanghe Shannen	Artevelde Hogeschool
	3.	Zouaoui Moune	Université Libre de Bruxelles
-63 kg	Aantal Deelnemers: 5		
	1	Billiet Sandrine	Universiteit Gent
	2	Lefevere Jolien	Katholieke Hogeschool Vives
	3	Meersman Katia	Ecole Royale Militaire
	3.	Vandewalle Emily	Katholieke Universiteit Leuven
-70 kg	Aantal Deelnemers: 4		
	1	Heyns Maxine	Universiteit Gent
	2	Van Droogenbroeck Marjolein	Ecole Royale Militaire
	3	Hintjes Stacy	Katholieke Hogeschool Vives
	3.	Willaert Marie-Laure	Katholieke Universiteit Leuven
-78 kg	Aantal Deelnemers: 2		
	1	Fizaine Laurie	Ecole Royale Militaire
	2	Burton Madeleine	Université Catholique de Louvain
+78 kg	Aantal Deelnemers: 3		
	1	Rolland Céline	HE de la Province de Liège
	2	Timbermont Evelien	Vrije Universiteit Brussel
	3	Mula Manuela	HE Louvain en Hainaut



Heren U21+

Gewicht:	Plaats	Naam	Club
-60 kg	Aantal Deelnemers: 4		
	1	Losapio Matteo	Artesis Plantijn Hogeschool Antwerpen
	2	Plomb Nicolas	Université Catholique de Louvain
	3	Engels Martijn	Katholieke Universiteit Leuven
	3.	Blommaert Gauthier	Hogeschool Gent
-66 kg	Aantal Deelnemers: 8		
	1	Maigret Samuel	HE Francisco Ferrer
	2	Bentein Jill	Hogeschool West-Vlaanderen
	3	Pire Adrien	Ecole Royale Militaire
	3	Patris Roman	Université Libre de Bruxelles
-73 kg	Aantal Deelnemers: 12		
	1	Pavanelli Lira Victor Manoel	Universiteit Gent
	2	De Pelseener Tom	Katholieke Hogeschool Sint-Lieven
	3	Robijn Jens	Artesis Plantijn Hogeschool Antwerpen
	3	Seeldraeyers Gianni	Katholieke Universiteit Leuven
-81 kg	Aantal Deelnemers: 15		
	1	Timmermans Kristof	Universiteit Antwerpen
	2	Pletinckx Timothy	EPHEC
	3	Desender Bruce	Katholieke Hogeschool Vives
	3	Auspert Marvin	HE de Namur Liège Luxembourg
-90 kg	Aantal Deelnemers: 11		
	1	Aelbrecht Maarten-Jan	Vrije Universiteit Brussel
	2	Hoste Jelle	Katholieke Hogeschool Vives
	3	Robberechts Nicolas	HE de Namur Liège Luxembourg
	3	De Blauwe Arne	Hogeschool West-Vlaanderen
-100 kg	Aantal Deelnemers: 6		
	1	Capelle Charles	HE de Namur Liège Luxembourg
	2	Dekeyser Roel	Katholieke Universiteit Leuven
	3	Goethals Thijs	Ecole Royale Militaire
	3	Detollenaere Wouter	Katholieke Universiteit Leuven
+100 kg	Aantal Deelnemers: 1		
	1	Glowacki Aymerick	Université Catholique de Louvain



Vives Campus Torhout
BSK Judo
2 april 2014

Categorie : **Heren** -60 kg Mat :

	Naam+Voornaam, Club	Graad	1-2	3-4	1-3	2-4	1-4	2-3	OVERW.	PUNTEN	PLAATS
1	Blommaert Gauthier Hogeschool Gent	58,6	0%		0%		0%		0	0	4
2	Plomb Nicolas Université Catholique de Louvain	60	1/10			1/10		0%	2	20	2
3	Losapio Matteo Artesis Plantijn Hogeschool Antwerpen	59,8		1/10	1/10			1/10	3	30	1
4	Engels Martijn Katholieke Universiteit Leuven	59,6		0%		0%	1/10		1	10	3

alleen technische punten invullen

Wedstrijdduur : 4'

Ippon = 10 Waza-Ari = 7 Yuko = 5 Shido = 1

T.O.:

02/04/14 13:00

Heren -66 kg

Wedstrijdduur : 4'

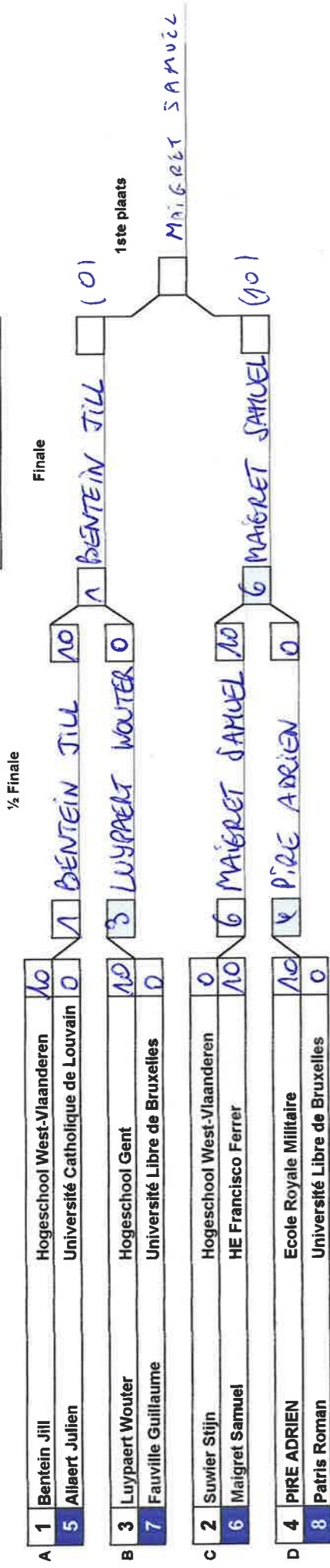

Kolom 1

Kolom 1

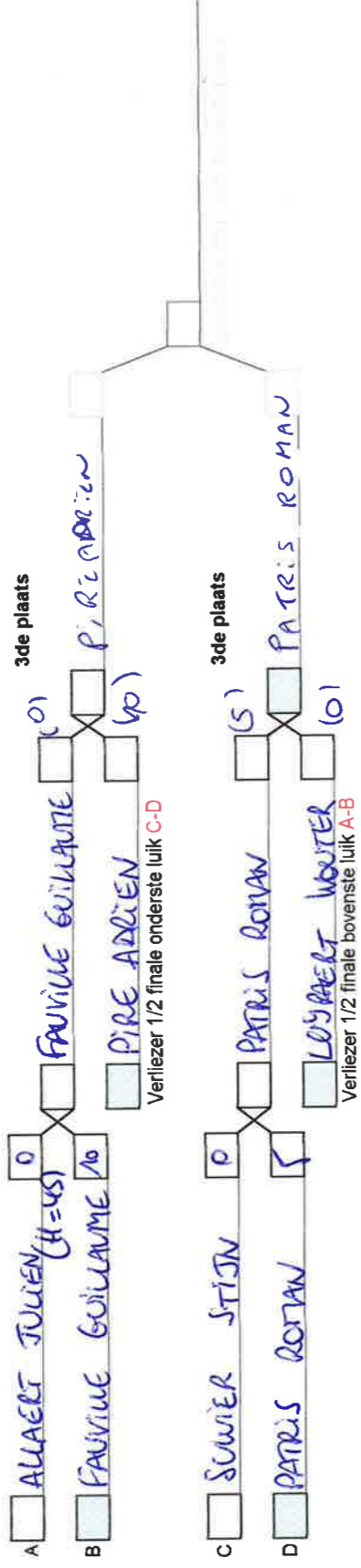

Dubbele herkansing

ippon = 10 Waza-Ari = 7 Yuko = 5 Shido = 1



BSK Judo
Vives Campus Torhout
2/04/2014
02/04/14 13:00

Heren -100 kg

Wedstrijdduur : 4'

1/2 Finale

A	1	Dekeyser Roel	Katholieke Universiteit Leuven	10
B	3	Vandyck Mathys	Katholieke Hogeschool Limburg	
C	2	Detollenaere Wouter	Katholieke Universiteit Leuven	0
D	4	Dziergwa Jonathan	Thomas More Kempen	
	5	GOETHALS Thijs	Ecole Royale Militaire	0
	6	Capelle Charles	HE de Namur Liège Luxembourg	5
	7			
	8			

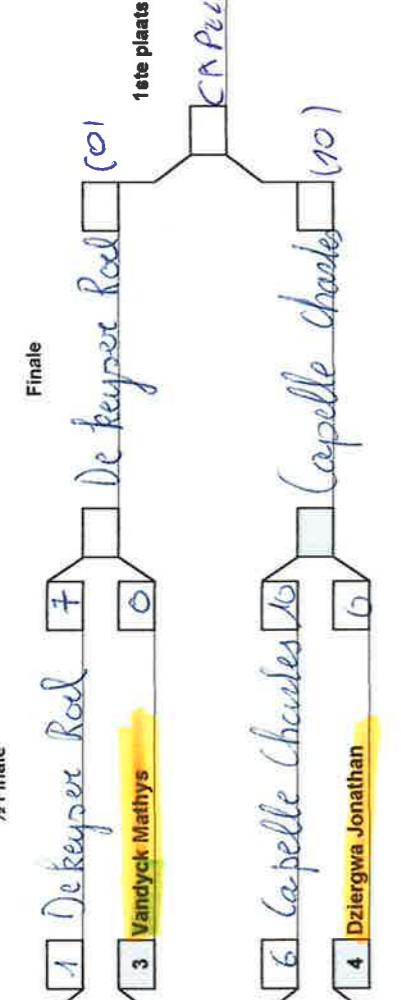

Kolom 1

Kolom 1

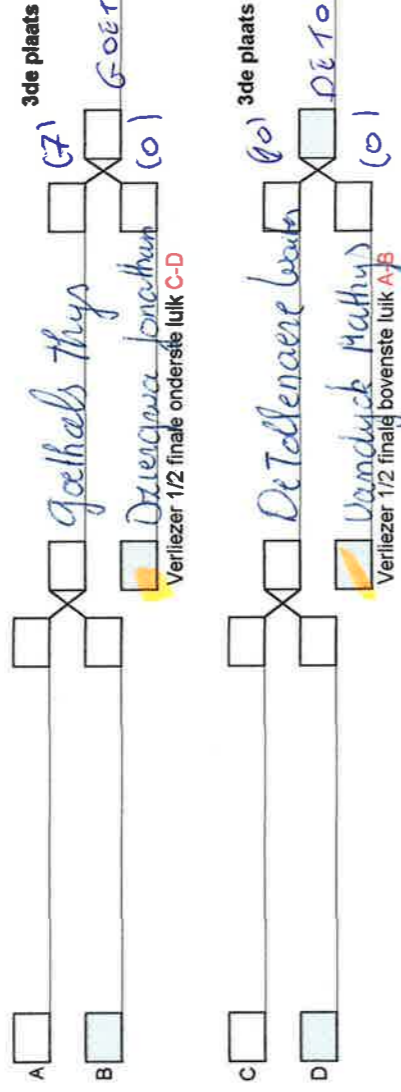

Dubbele herkansing

ippon = 10 Waza-Ari = 7 Yuko = 5 Shido = 1

BSK Judo
Vives Campus Torhout
2/04/2014
02/04/14 13:00





Vives Campus Torhout
BSK Judo
2 april 2014

Categorie : Dames -48 kg Mat :

	Naam+Voornaam, Club	Graad	1-2	OVERW.	PUNTEN	PLAATS
1	Corvelyn Marlies Katholieke Universiteit Leuven	47,2	1 00	0	0	2
2	Audiens Evelyne Universiteit Antwerpen	47,7	2 10/10	2	20	1

alleen technische punten invullen

Wedstrijdduur : 4'

Ippon = 10 Waza-Ari = 7 Yuko = 5 Shido = 1

T.O.:

02/04/14 13:00



Vives Campus Torhout
BSK Judo
2 april 2014

Categorie : Dames -52 kg Mat :

	Naam+Voornaam, Club	Graad	1-2	OVERW.	PUNTEN	PLAATS
1	Delanghe Karen Artevelde Hogeschool	51,3	1 0 0	0	0	2
2	Declerck Rani Katholieke Hogeschool Vives	52	2 10 10	2	20	1

alleen technische punten invullen

Wedstrijdduur : 4'

Ippon = 10 Waza-Ari = 7 Yuko = 5 Shido = 1

T.O.:

02/04/14 13:00



Vives Campus Torhout
BSK Judo
2 april 2014

Categorie : Dames **-57 kg** **Mat :**

	Naam+Voornaam, Club	Graad	1-2	3-4	1-3	2-4	1-4	2-3	OVERW.	PUNTEN	PLAATS
1	Armórsdóttir Ásta Lovísa Université Libre de Bruxelles	56	10 ^x		10 ^y		0 ^x		2	20	2
2	Zouaoui Moune Université Libre de Bruxelles	55,7	0 ^y			0 ^x		0 ^x	0	0	4
3	Delanghe Shannen Artevelde Hogeschool	56,6		0 ^x	0 ^x			10 ^x	1	10	3
4	Denoo Lotte Artevelde Hogeschool	56,9		10 ^y		10 ^x			3	30	1

alleen technische punten invullen

Wedstrijdduur : 4'

Ippon = 10 Waza-Ari = 7 Yuko = 5 Shido = 1

T.O.:

02/04/14 13:00



Vives Campus Torhout
BSK Judo
2 april 2014

Categorie : **Dames** -63 kg Mat :

1	2	3	4	5	Graad	1-2	3-4	4-5	2-3	4-5	1-3	2-4	3-5	1-4	2-5	OVERW.	PUNTEN	PLAATS
						0	0	0	0	0	0	0	0	0	0			
1	Lefevere Jolien Katholieke Hogeschool Vives	62,4	0	0	0	0	0	0	0	0	0	0	0	0	0	3	30	2
2	Billiet Sandrine Universiteit Gent	62,4	0	0	0	0	0	0	0	0	0	0	0	0	0	4	40	1
3	Vandewalle Emily Katholieke Universiteit Leuven	62,8	0	0	0	0	0	0	0	0	0	0	0	0	0	1	10	4
4	Thijs Kim Artevelde Hogeschool	57,8	0	0	0	0	0	0	0	0	0	0	0	0	0	0	0	5
5	Meersman Katia Ecole Royale Militaire	61,9	0	0	0	0	0	0	0	0	0	0	0	0	0	2	20	3

alleen technische punten invullen

Wedstrijdduur : 4'

Ippon = 10 Waza-Ari = 7 Yuko = 5 Shido = 1

T.O.:

02/04/14 13:00



Vives Campus Torhout
BSK Judo
2 april 2014

Categorie : Dames **-70 kg** **Mat :**

	Naam+Voornaam, Club	Graad	1-2	3-4	1-3	2-4	1-4	2-3	OVERW.	PUNTEN	PLAATS
1	Hintjes Stacy Katholieke Hogeschool Vives	68,4	0		no		0		1	10	3
2	Van Droogenbroeck Marjolein Ecole Royale Militaire	68,3	no			0		no	2	20	2
3	Willaert Marie-Laure Katholieke Universiteit Leuven	67,1		0(45)	0			0	0	0	4
4	Heyns Maxine Universiteit Gent	68,2		no		no	5		3	25	1

alleen technische punten invullen

Wedstrijdduur : 4'

Ippon = 10 Waza-Ari = 7 Yuko = 5 Shido = 1

T.O.:

02/04/14 13:00



Vives Campus Torhout
BSK Judo
2 april 2014

Categorie : Dames -78 kg Mat :

	Naam+Voornaam, Club	Graad	1-2	OVERW.	PUNTEN	PLAATS
1	Burton Madeleine Université Catholique de Louvain	75,7	1 00	0	0	2
2	Fizaine Laurie Ecole Royale Militaire	74,1	2 10/10	2	20	1

alleen technische punten invullen

Wedstrijdduur : 4'

Ippon = 10 Waza-Ari = 7 Yuko = 5 Shido = 1

T.O.:

02/04/14 13:00



Vives Campus Torhout
BSK Judo
2 april 2014

Categorie : **Dames** +78 kg Mat :

	Naam+Voornaam, Club	Graad	1-2	2-3	1-3	OVERW.	PUNTEN	PLAATS
1	Rolland Céline HE de la Province de Liège	87,9	7		10	2	17	1
2	Timbermont Evelien Vrije Universiteit Brussel	81,7	0	10		1	10	2
3	Mula Manuela HE Louvain en Hainaut	79,4		0(45)	0	0	0	3

alleen technische punten invullen

Wedstrijdduur : 0

Ippon = 10 Waza-Ari = 7 Yuko = 5 Shido = 1

T.O.:

4'

02/04/14 13:00

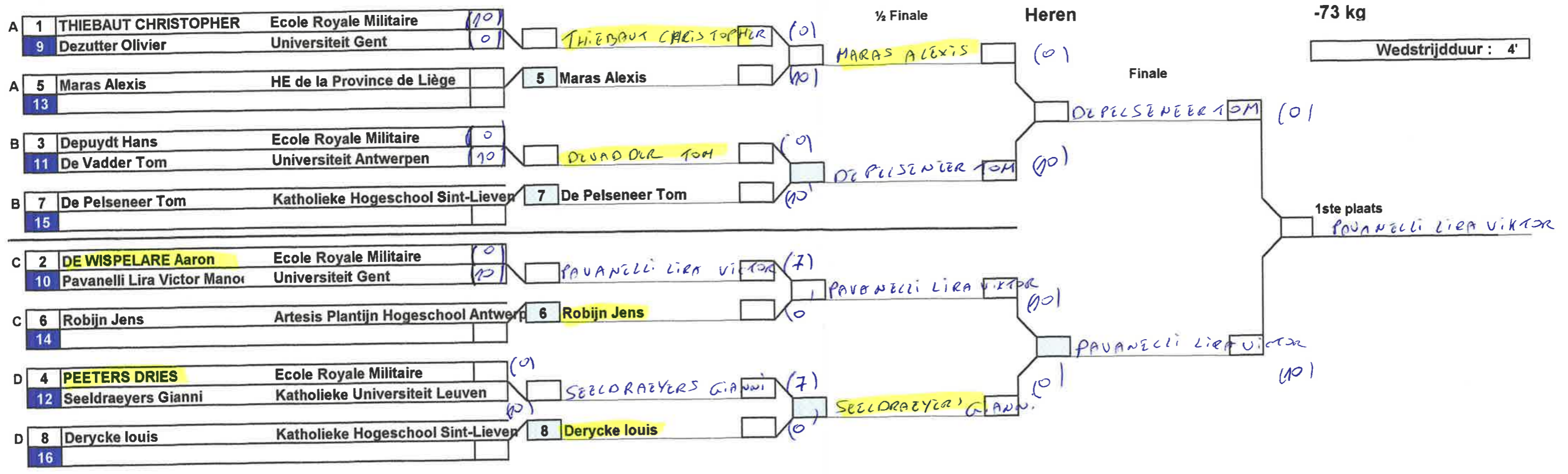

kolom 1

kolom 2

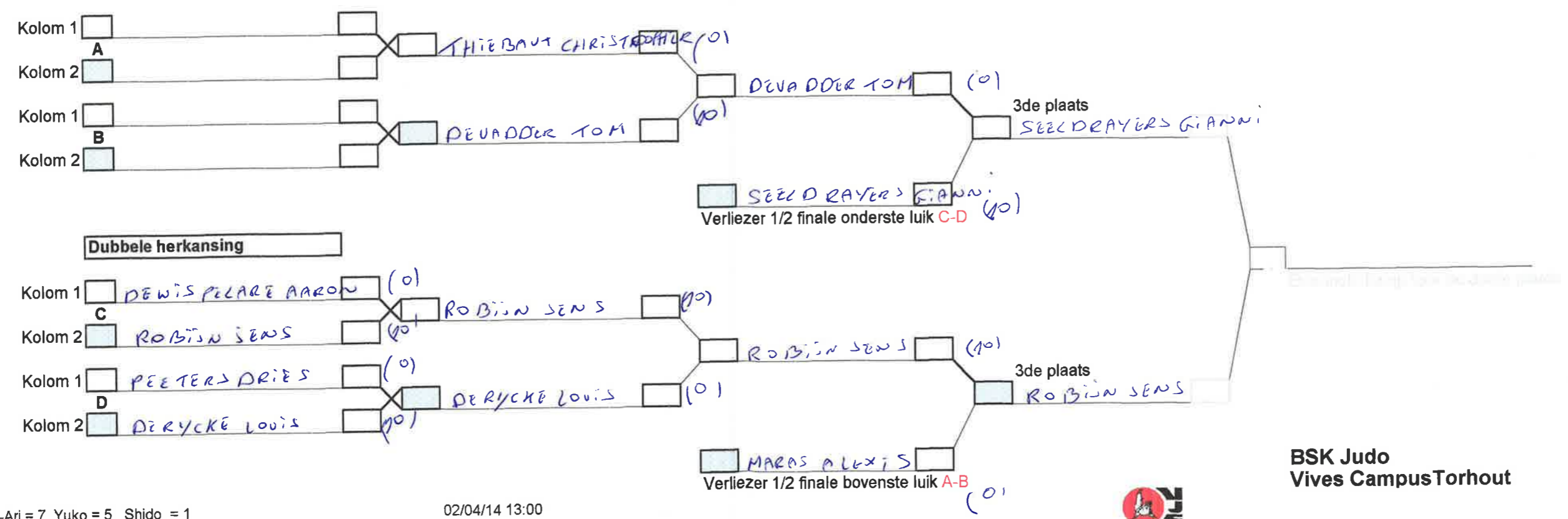

Ippon = 10 Waza-Ari = 7 Yuko = 5 Shido = 1

02/04/14 13:00



BSK Judo
Vives Campus Torhout

02/04/14

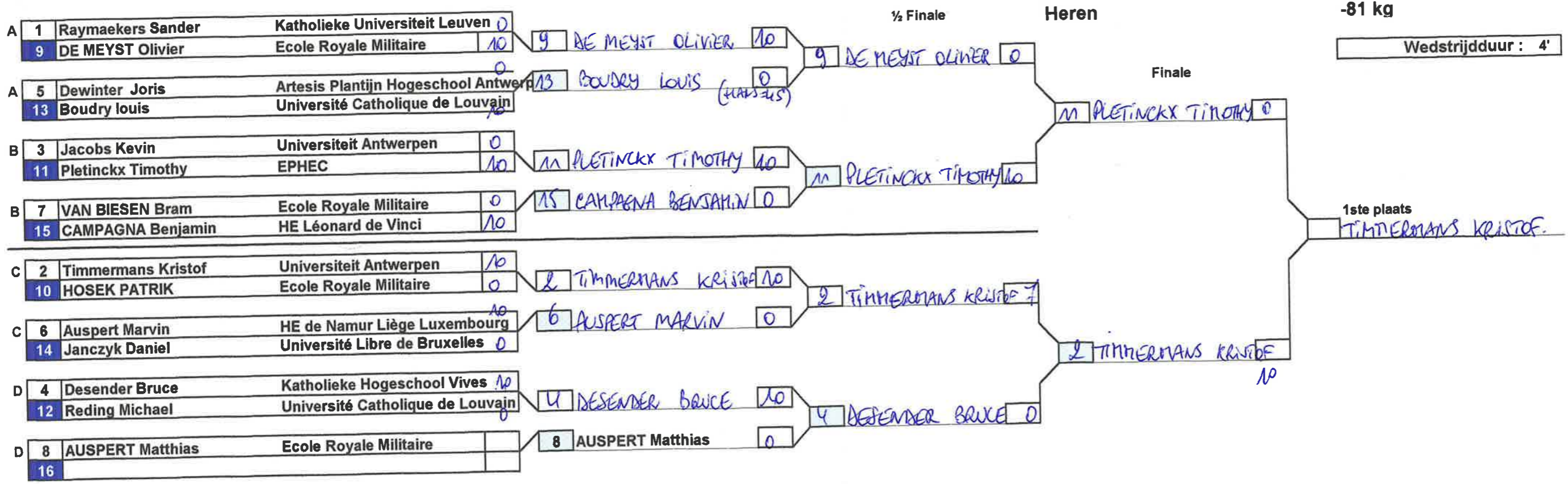

kolom 1

kolom 2

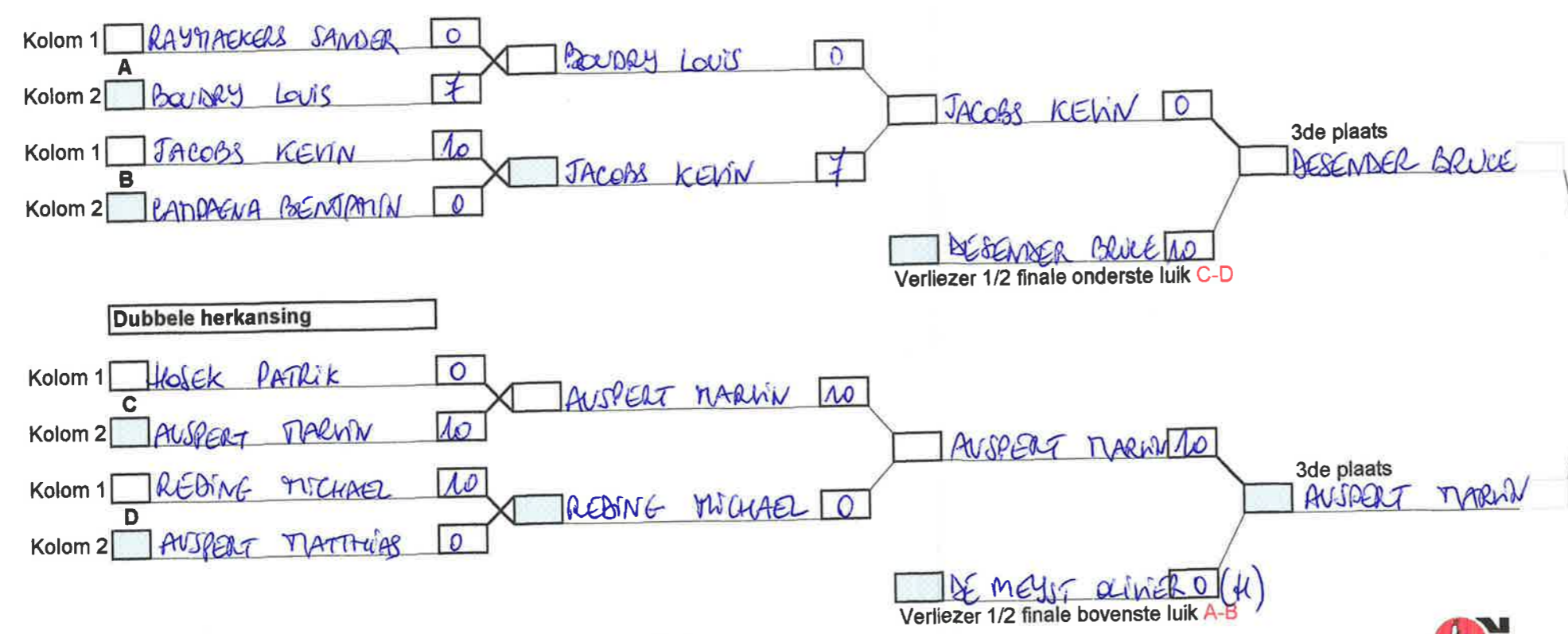

□ Ippon = 10 Waza-Ari = 7 Yuko = 5 Shido = 1

02/04/14 13:00



BSK Judo
Vives Campus Torhout

02/04/14

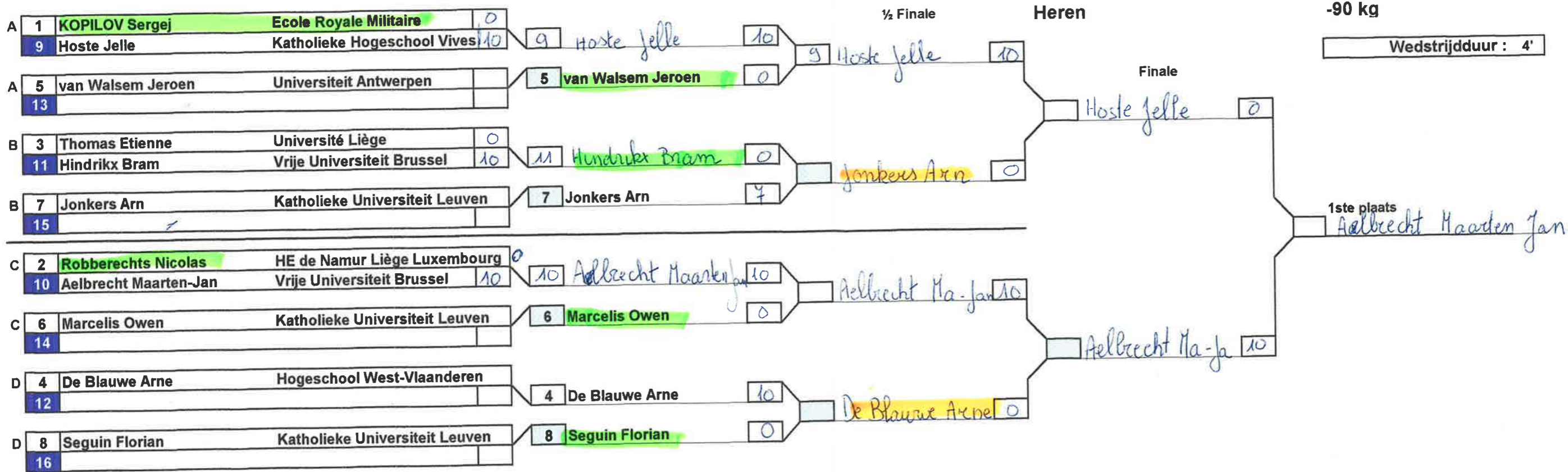

kolom 1

kolom 2

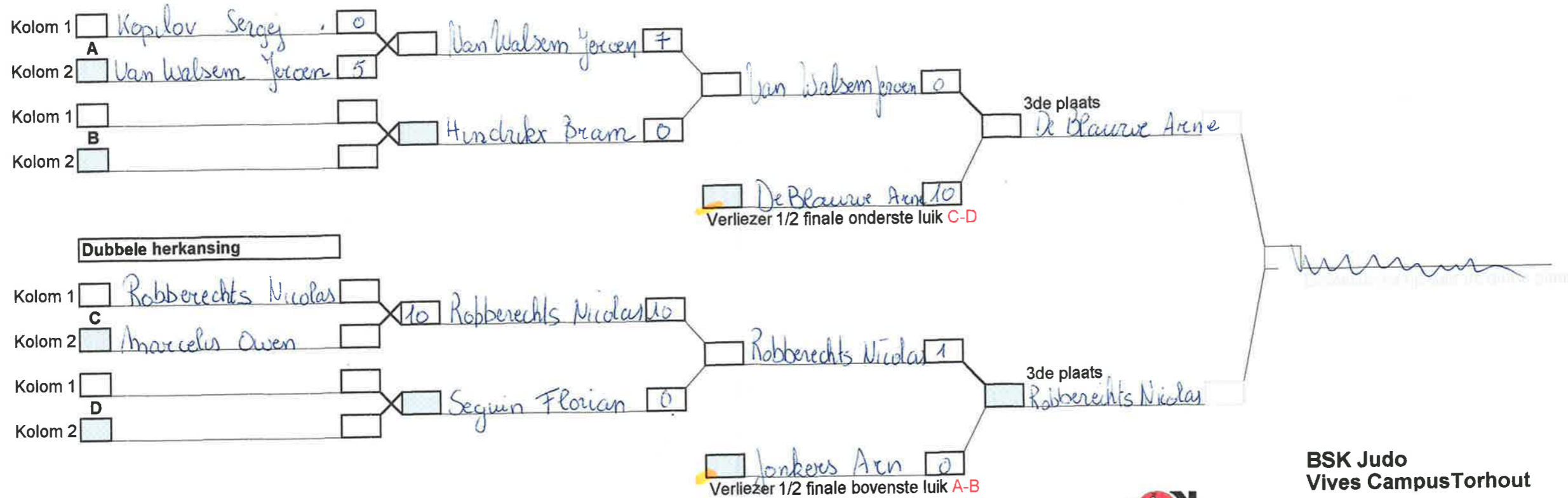

Ippon = 10 Waza-Ari = 7 Yuko = 5 Shido = 1

02/04/14 13:00



BSK Judo
Vives Campus Torhout

02/04/14

Mercredi 27 Novembre 2013 Championnat Enseignement Supérieur

INFORMATIONS GENERALES :

- * **PESEE** : de 12h à 13h, début des combats 13h30.
- * **CATEGORIES** : dames -57, -63, +63 ;
hommes -66, -73, -81, -90, +90.
- * **REGLES** : durée des combats H & D 4 minutes.
Equipe max. de 8 judokas (5H & 3D),
min. 5 judokas avec min. 1 dame.
- * **LIEU** : **ERM**,
Avenue de la Renaissance 30, 1000 Bruxelles.
- * Compétition sur 2 tatamis.

INSCRIPTIONS :

Maximum 2 équipes par institution.

En ligne via le lien : <http://www.aseus.be/formulaire/2188>

Clôture le lundi 20/11/2013 à 16h00.

Attention, clôture anticipative possible sous réserve de disponibilités.

Le responsable sport de ton institution recevra une confirmation de l'inscription de ton équipe par mail.

Inscris-toi sans attendre grâce à ton smartphone et ce QR-CODE !



Résultats du Championnat FSUB de judo par équipe

Ecole Royale Militaire

Mercredi 27 novembre 2013





ERM	2013	mercredi 27/11/2013
-----	------	---------------------

Time
4 Min

poule A

Bogdan DANNEVOY
 Coordinateur Sportif
 0495/223.217

ASEUS

Association Sportive de l'Enseignement
 Universitaire et Supérieur asbl

Secrétariat : rue Fond de Malonne, 127 - 5020 Malon
 Tél. 081/44 44 01 - Fax 081/44 66 01 - www.aseus.t

	Université	1		2		3		Victoires	Victoires individuelles	points	place
		6	42	4	31	3	30				
1	KUL 1			0		2		2	7	55	3
		2	20	5	35						
2	Ugent	2				0		2	9	72	1
		6	42	3	30						
3	ERM	0		2		0		2	7	61	2
		3	30	4	31						

Poule de 3 : 1/2 2/3 1/3

PDF Editor



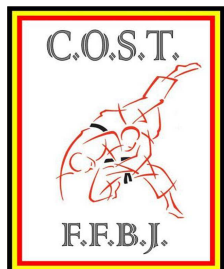

ERM	2013	mercredi 27/11/2013
-----	------	---------------------

Time
4 Min

poule B



	Université	1		2		3		Victoires	Victoires individuelles	points	place
1	KUL 2			0		0		0	6	57	3
		3	30	3	27						
2	UCL	2				2		4	6	90	1 TM
		4	40	2	50						
3	ULB	2		0				2	8	80	2
		5	50	3	30						

Poule de 3 : 1/2 2/3 1/3



PDF Editor

Poule

ERM	2013	mercredi 27/11/2013
-----	------	---------------------

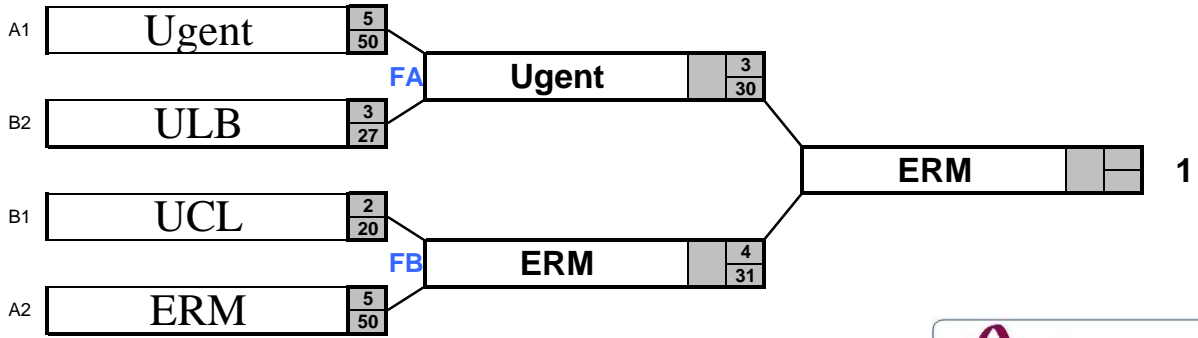

 Bogdan DANNEVOYE
 Coordinateur Sportif
 0495/223.217
ASEUS
 Association Sportive de l'Enseignement
 Universitaire et Supérieur asbl
 Secrétariat : rue Fond de Malonne, 127 - 5020 Malonne
 Tél. 081/44 44 01 - Fax 081/44 66 01 - www.aseus.be

1	ERM
2	Ugent
3	UCL
4	ULB
5	KUL 1
6	KUL 2

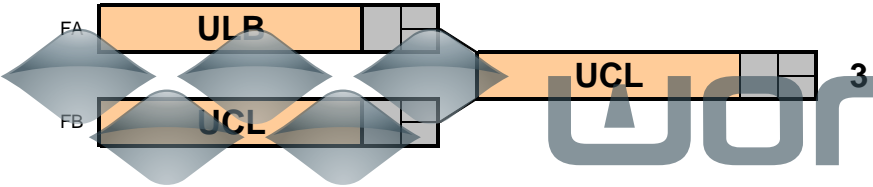

WondershareTM

PDF Editor



Mercredi 19 Mars 2014 Championnat Enseignement Supérieur

INFORMATIONS GENERALES :

- * **HORAIRE** : Echauffement : 13h30,
début des compétitions : 14h30 .
- * **REGLES** : Max. 2 épreuves individuelles par nageurs,
mais possibilité de participer à toutes les courses relais.
Max. 3 nageurs par centre.
Voir règlement complet sur site ASEUS.
- * **LIEU** : **GUSB Gent**,
Watersportlaan 3, 9000 Gent.

INSCRIPTIONS :

En ligne via le lien : <http://www.aseus.be/formulaire/2129>

Clôture le vendredi 14/03/2014 à 12h00.

Attention, clôture anticipative possible sous réserve de disponibilités.

Le responsable sport de ton institution recevra une confirmation de ton inscription par mail.

Inscris-toi sans attendre grâce à ton smartphone et ce QR-CODE !



BUSF - KAMPIOENSCHAP ZWEMMEN Gent, 19 maart 2014 - Uitslagen

1 200m wisselslag H

baan	plaats	naam	tijd	instelling
	1	Deolet Timothy	02:07;10	Universiteit Gent
	2	Verjans Renaud	02:17;76	Université de Liège
	3	Didier Droogné	02:22;32	Universiteit Gent
	4	Crouquet Adrien	02:23;07	UCL
	5	Lambrecht Arno	02:24;81	KUL
	6	De Witte Glenn	02:25;95	KUL
	7	Billion Arthur	2:29;58	UCL
	8	Devos Rutger	02:31;00	École Royale Militaire
	9	Picavet Maxence	02:32;20	HE de Namur Liège Luxembourg
	10	Mahoux Rodolphe	2:35;10	UCL
	11	Dahin Adrien	DNS	HE Libre Mosane

2 200m wisselslag D

			tijd	
	1	Clément Kimberley	02:26;78	Université Libre de Bruxelles
	2	Buyck Sara	02:38;36	Universiteit Gent
	3	Lecoutere Katrijn	02:40;44	KUL
	4	Lacroix Marielle	02:41;46	UCL
	5	Basslé Annelies	02:43;26	KUL
	6	Bremond Maeva	02:45;48	UCL
	7	Colmant Lise	02:56;42	UCL

3 50m vrije slag H

			tijd	
	1	Bourlier Vincent	00:24;42	Université Libre de Bruxelles
	2	Van Mechelen Ken	00:24;55	KUL
	3	Vanholme Pieter	00:24;68	Universiteit Gent
	8	Beelprez Jonas	00:24;96	KUL
	4	Mavroudis Yanni	00:25;13	HE Libre Mosane
	5	Terryn Julien	00:25;15	Artevelde Hogeschool
	6	Lenaerts Mike	00:25;22	UCL
	7	Van Damme Maarten	00:25;24	Universiteit Gent
	9	Hassayoune Mouseddine	00:25;40	Université de Namur
	11	Francotte Sebastien	00:25;75	Université Libre de Bruxelles
	12	Tamagna Léo	00:25;87	Université de Liège
	10	Dantec Gaetan	00:26;12	Université de Liège
	13	Salvan Quentin	00:26;28	Université de Liège
	14	Varewyck Charly	00:26;36	UCL
	15	Gilles Boerhave	00:26;51	Universiteit Gent

16	Puddu Jerome	00:27;06	École Royale Militaire
17	Van Liefvering François	00:27;32	Université Libre de Bruxelles
18	Heremans Julien	00:27;39	École Royale Militaire
19	Verbeeck Tom	00:27;51	École Royale Militaire
20	Thouvenin Arthur	00:27;53	UCL
21	Aguayo Garcia Lucas	00:27;57	Université Libre de Bruxelles
22	Lorenzetti Ephrem	00:27;59	HE de Namur Liège Luxembourg
23	Meeusen Tom	00:28;85	KUL
24	Merveille Rodolf	00:29;65	Université de Namur
25	Fakhreddine Ahmed	DNS	HE de la Province de Liège
26	Nguyen Thomas	DNS	HE Libre Mosane
27	De Potter Quentin	DNS	HE Paul-Henri Spaak
28	Van Breusegem Mathias	DNS	Universiteit Gent

4 50m vrije slag D

		tijd	
1	Cavadini Caroline	00:27;46	Université Libre de Bruxelles
2	Baum Sydney	00:28;19	UCL
3	Mattheus Emily	00:28;26	KUL
4	Di Battista Gloria	00:29;11	HE Paul-Henri Spaak
5	Schreurs Katrijn	00:29;28	KUL
6	Demaegd Lisbeth	00:29;34	KUL
7	Jaques Delphine	00:29;70	Universiteit Gent
8	Niké Ponnet	00:29;91	Universiteit Gent
10	Tielemans Kristy	00:30;88	École Royale Militaire
9	Spletinckx Sandrine	00:31;26	École Royale Militaire
11	Audrin Charlotte	00:31;39	UCL
12	Boussuge-Aubert Jade	00:31;87	UCL
13	De Berdt Laura	00:35;22	Université Libre de Bruxelles
14	Simon Alisone	00:40;03	Université de Namur
15	Moinet Perrine	00:40;26	Université Libre de Bruxelles
16	Castronovo Fiona	DNS	Université de Liège
17	Vrijens Céline	DNS	Université de Liège

5 100m rugslag H

		tijd	
1	Verjans Renaud	00:56;38	Université de Liège
2	Cabrol Alexis	00:57;54	Université Libre de Bruxelles
3	Etienne Tom	00:59;99	Universiteit Hasselt
4	Lecoutere Jeroen	01:00;96	KUL
5	Gysemberg Cedric	01:01;69	KUL
6	Bolckmans Lenz	01:02;14	KUL
7	Dantec Gaetan	01:03;39	Université de Liège
8	Rydant Hannes	01:04;75	Universiteit Gent
9	Van Breusegem Mathias	01:05;23	Universiteit Gent
10	Colognesi Victor	01:06;28	UCL
11	Roblin Joachim	01:06;69	UCL
12	Lambert Gatien	01:07;84	UCL
13	Fasseur Frederick	01:14;54	École Royale Militaire
14	Alsteens Barthelemy	01:19;27	École Royale Militaire

6 100m rugslag D

		tijd	
1	Goethals Hilkje	01:08;22	Universiteit Gent
2	Clément Kimberley	01:09;31	Université Libre de Bruxelles
3	Roland Olivia	01:11;32	UCL
4	Meeus Marie	01:12;02	UCL
5	Ver Eecke Emily	01:13;95	Universiteit Gent
6	Van Noorden Miriam	01:15;44	KUL
7	Boets Isabelle	01:20;21	KUL
8	Pruszyńska Jacqueline	01:27;23	Université de Namur

7 100m schoolslag H

		tijd	
1	Cabrol Maxime	01:05;60	Université Libre de Bruxelles
2	Jonas Leyssens	01:06;53	Universiteit Gent
3	Decossaux Valentin	01:07;22	UCL
4	Verachtert Ruben	01:09;66	KUL
5	Patrick Demey	01:10;11	Universiteit Gent
6	Vanholme Pieter	01:11;13	Universiteit Gent
7	Pietermans Sjors	01:12;60	KUL
8	Ricquier Thomas	01:14;87	KUL
9	De Meunynck Yvan	01:16;51	UCL
10	Arinaga Matteus	01:28;22	École Royale Militaire
11	Fasseur Frederick	01:28;63	École Royale Militaire
12	Veys Quentin	01:29;78	Université de Namur
13	Koob Gregory	DNS	HE de Namur Liège Luxembourg

8 100m schoolslag D

		tijd	
1	Lecoutere Katrijn	01:21;86	KUL
2	Van Erum Eva	01:22;87	Universiteit Gent
3	Chrétien Sophie	01:26;35	École Royale Militaire
4	Leffin Valentine	01:27;83	Université de Namur
5	L'Homme Amelie	01:31;06	École Royale Militaire
6	Hainaut Ines	01:31;78	UCL
7	Hensels Audrey	01:32;37	KUL
8	Artigas Joanna	01:32;99	Université Libre de Bruxelles
9	Wynant Stephanie	01:35;84	École Royale Militaire
10	Desonniaux Marie	01:37;57	Université de Namur
11	Stiepen Axelle	01:46;60	Université de Namur

9 100m vlinderslag H

		tijd	
1	De Wilde Gilles	00:57;31	Universiteit Gent
2	Etienne Tom	00:59;84	Universiteit Hasselt
3	Terryn Julien	01:00;76	Artevelde Hogeschool
4	Didier Droogné	01:02;47	Universiteit Gent
5	De Witte Glenn	01:03;37	KUL
6	Rydant Hannes	01:04;72	Universiteit Gent
7	Lambrecht Arno	01:04;77	KUL
8	Picavet Maxence	01:05;23	HE de Namur Liège Luxembourg
9	Grosdent Thomas	01:05;38	UCL
10	Billion Arthur	01:06;23	UCL
11	Berteloot Ruben	01:09;14	Katholieke Hogeschool Vives
12	Thouvenin Arthur	01:10;06	UCL
13	Coppin Georges	01:10;53	Université Libre de Bruxelles
14	Van Liefferinge François	01:11;50	Université Libre de Bruxelles
15	Verbeeck Tom	01:15;72	École Royale Militaire
16	Dahin Adrien	DNS	HE Libre Mosane

10 100m vrije slag D

		tijd	
1	Cavadini Caroline	00:59;34	Université Libre de Bruxelles
2	Huybreghs Nele	01:00;39	KUL
3	Goethals Hilkje	01:02;81	Universiteit Gent
4	Mattheus Emily	01:04;09	KUL
5	Meeus Marie	01:05;00	UCL
6	Basslé Annelies	01:07;69	KUL
7	Bremond Maeva	01:07;76	UCL
8	Boussuge-Aubert Jade	01:09;56	UCL
9	Leffin Valentine	01:12;02	Université de Namur
10	Pruszyńska Jacqueline	01:18;75	Université de Namur
11	Desonniaux Marie	01:22;21	Université de Namur
12	Stiepen Axelle	01:23;20	Université de Namur
13	Simon Alisone	01:31;58	Université de Namur
14	Vrijens Céline	DNS	Université de Liège
15			

11 100m vrije slag H

		tijd	
1	Cabrol Alexis	00:52;41	Université Libre de Bruxelles
2	Lecoutere Jeroen	00:53;16	KUL
3	Bourlier Vincent	00:53;75	Université Libre de Bruxelles
4	Lenaerts Mike	00:54;69	UCL
5	Vanholme Pieter	00:55;13	Universiteit Gent
6	Van Breusegem Mathias	00:56;98	Universiteit Gent
7	Mavroudis Yanni	00:57;51	HE Libre Mosane
8	Boerhave Gilles	00:57;70	Universiteit Gent
9	Hassayoune Mouseddine	00:58;41	Université de Namur
10	Francotte Sebastien	00:58;53	Université Libre de Bruxelles
11	Varewyck Charly	00:59;79	UCL
12	Lorenzetti Ephrem	01:00;09	HE de Namur Liège Luxembourg
13	D'Hooghe Ben	01:00;28	KUL
14	Heremans Julien	01:00;78	École Royale Militaire
15	Mahoux Rodolphe	01:01;10	UCL
16	Meeusen Tom	01:03;74	KUL
17	Puddu Jerome	01:04;31	École Royale Militaire
18	Merveille Rodolf	01:06;00	Université de Namur
19	Arinaga Matteus	01:06;29	École Royale Militaire
20	Veys Quentin	01:15;59	Université de Namur
21	Fakreddine Ahmed	DNS	HE de la Province de Liège

12 50m rugslag D

		tijd	
1	Delphine Jaques	00:31;98	Universiteit Gent
2	Roland Olivia	00:32;45	UCL
3	Ver Eecke Emily	00:33;89	Universiteit Gent
4	Van Noorden Miriam	00:34;64	KUL
5	Lacroix Marielle	00:35;91	UCL
6	Spletinckx Sandrine	00:38;39	École Royale Militaire

13 200m rugslag H

		tijd	
1	Bolckmans Lenz	02:14;79	KUL
2	Gysemberg Cedric	02:14;98	KUL
3	Van Damme Maarten	02:21;84	Universiteit Gent
4	Roblin Joachim	02:22;41	UCL
5	Colognesi Victor	02:24;35	UCL
6	Lambert Gatien	02:31;78	UCL

14 50m schoolslag D

		tijd	
1	Eva Van Erum	00:37;25	Universiteit Gent
2	Chevallier Camille	00:37;91	Université Libre de Bruxelles
3	Chrétien Sophie	00:38;50	École Royale Militaire
4	Boogaerts Lize	00:39;89	KUL
5	Boogaerts Sofie	00:40;25	KUL
6	L'Homme Amelie	00:40;32	École Royale Militaire
7	Audrin Charlotte	00:41;80	UCL
8	Hainaut Ines	00:42;12	UCL
9	Hensels Audrey	00:42;55	KUL
10	Wynant Stephanie	00:42;80	École Royale Militaire
11	Artigas Joanna	00:43;17	Université Libre de Bruxelles

15 200m schoolslag H

		tijd	
1	Cabrol Maxime	02:22;58	Université Libre de Bruxelles
2	Jonas Leyssens	02:23;03	Universiteit Gent
3	Decossaux Valentin	02:29;07	UCL
4	Verachtert Ruben	02:33;84	KUL
5	Ricquier Thomas	02:47;53	KUL
6	D'Hooghe Ben	02:52;10	KUL
7	Berteloot Ruben	02:55;51	Katholieke Hogeschool Vives
8	Koob Gregory	DNS	HE de Namur Liège Luxembourg

16 50m vlinderslag D

		tijd	
	Baum Sydney	00:29;97	UCL
	Di Battista Gloria	00:31;02	HE Paul-Henri Spaak
	Schreurs Katrijn	00:31;89	KUL
	Demaegd Lisbeth	00:31;94	KUL
	Sara Buyck	00:32;33	Universiteit Gent
	Leysen Ayrore	00:33;28	UCL
	Chevallier Camille	00:33;78	Université Libre de Bruxelles
	Boogaerts Sofie	00:34;67	KUL
	Niké Ponnet	00:35;53	Universiteit Gent
	Tielemans Kristy	00:36;70	École Royale Militaire
	Colmant Lise	00:37;54	UCL

17 200m vrije slag H

		tijd	
1	Deolet Timothy	01:52;86	Universiteit Gent
2	De Wilde Gilles	01:56;97	Universiteit Gent
3	Beelprez Jonas	02:03;15	KUL
4	Demey Patrick	02:03;53	Universiteit Gent
5	Crouquet Adrien	02:03;86	UCL
6	Van Mechelen Ken	02:04;01	KUL
7	Grosdent Thomas	02:12;07	UCL
8	Devos Rutger	02:16;44	École Royale Militaire
9	Thoral Florrent	DNS	UCL

18 4*50 vrije slag H

		tijd
1	UGent1	01:35;91
2	KUL1	01:38;91
3	UCL1	01:39;30
4	ULB	01:39;60
5	Ugent2	01:41;47
6	Ulg	01:41;83
7	KUL2	01:46;22
8	UCL2	01:47;94
9	ERM	01:49;37
10	U Namur	01:55;91

19 4*50 vrije slag D

		tijd
1	KUL1	01:55;48
2	UCL1	01:57;62
3	Ugent	01:57;76
4	KUL2	02:00;34
5	ULB	02:03;16
6	ERM	02:04;89
7	UCL2	02:05;41
8	U Namur	02:19;37

20 4*50 wisselslag H

		tijd
1	UGent1	01:48;32
2	KUL1	01:50;34
3	ULB	01:51;20
4	UCL1	01:53;22
5	Ugent2	01:54;57
6	Ulg	01:55;25
7	KUL2	01:58;65
8	UCL2	02:00;47
9	ERM	02:10;16
10	U Namur	02:16;25

21 4*50 wisselslag D

		tijd
1	Ugent	02:09;58
2	UCL1	02:15;35
3	ULB1	02:16;97
4	KUL1	02:17;64
5	KUL2	02:22;04
6	UCL2	02:22;04
7	ERM	02:26;19

22 10*50 vrije slag mix

	tijd
Ugent	04:21;34
KUL1	04:22;94
ULB1	04:28;34
UCL1	04:30;92
KUL2	04:47;31
UCL2	04:52;82

Le jeudi 24 Octobre 2013 Tournoi Enseignement Supérieur

INFORMATIONS GENERALES :

- * **HORAIRE** : de 13h à 19h
- * Attention : pas de restauration sur place.
- * **LIEU** : KITURO RC,
Bloemtuinenlaan 50 bis (Cité des jardins),
1030 Schaerbeek.
- * Compétition sur 2 terrains synthétiques.
- * **INDISPENSABLE** : être en possession de sa carte étudiant
et de sa carte d'identité, ou de son permis de conduire.

INSCRIPTIONS :

10 joueurs minimum par équipe.
Possibilité d'inscrire 2 équipes par institution.

En ligne via le lien : <http://www.aseus.be/formulaire/2346>

Clôture le lundi 21/10/2013 à 16h00.

Attention, clôture anticipative possible sous réserve de disponibilités.

Le responsable sport de ton institution recevra une confirmation de l'inscription de ton équipe par mail.

Inscris-toi sans attendre grâce à ton smartphone et ce QR-CODE !





24/10/2013		TOURNOI DE RUGBY A 7 PROMOTIONNEL ASEUS/VSSF						
		KITURO-Schaerbeek						
Unifs ou Hé		ULB 1	HEVinci	HESpaak	HEPHC 1	ERM	ULB 2	
		HEPHC 2	UCL	HEFF	HEH	KHBO-VIVEF	HENALLUX	
	Heure	Eq Dom	Score		Eq Ext	Poule	Terrain	Arbitre
M1	14:00:00	ULB 1	36	0	HEFF	A	1	Catteau
M2	14:00:00	HEVinci	38	5	HEH	B	2	De Baere
M3	14:20:00	HESpaak	40	0	KHBO-VIVEF	C	1	Vandecauteur
M4	14:20:00	HEPHC 1	51	0	HENALLUX	D	2	Verzin
	14:40:00	UCL	0	43	KUL/Ulb	Dames	1	Catteau
M5	15:00:00	ERM	10	12	HEFF	A	1	De Baere
M6	15:00:00	ULB 2	15	5	HEH	B	2	Vandecauteur
	15:20:00	U18 BRC/ASUB	0	31	Barbarians Unifs		1	Catteau
M7	15:40:00	HEPHC 2	34	10	KHBO-VIVEF	C	1	Verzin
M8	15:40:00	UCL	53	0	HENALLUX	D	2	Catteau
M9	16:00:00	ULB 1	36	0	ERM	A	1	De Baere
M10	16:00:00	HEVinci	36	0	ULB 2	B	2	Vandecauteur
M11	16:20:00	HESpaak	22	0	HEPHC 2	C	1	Verzin
M12	16:20:00	HEPHC 1	12	28	UCL	D	2	Catteau
	17:00:00	Ulg/HEPHC	25	0	UCL	Dames	1	De Baere
	17:00:00	U18 BRC/ASUB	5	24	Barbarians Unifs		2	Vandecauteur
M13	17:20:00	ERM	22	0	KHBO-VIVEF	1/2 BOWL	1	Vandecauteur
M14	17:20:00	HEH	0	14	HENALLUX	1/2 BOWL	2	Verzin
M15	17:40:00	HEFF	29	0	HEPHC2	1/2 PLATE	1	Catteau
M16	17:40:00	ULB2	0	43	HEPHC1	1/2 PLATE	2	De Baere
M17	18:00:00	ULB1	33	7	HESpaak	1/2 CUP	1	Vandecauteur
M18	18:00:00	HEVinci	17	5	UCL	1/2 CUP	2	Verzin
	18:20:00	Ulg/HEPHC	10	12	KUL/Ulb	Dames	1	
M19	18:20:00	ERM	17	7	HENALLUX	Finale BOWL	2	Catteau
M20	18:40:00	HEFF	5	10	HEPHC1	Finale PLATE	1	De Baere
M21	18:40:00	HESpaak	7	19	UCL	3ème place	2	Vandecauteur
Ou U18 BRC/ASUB - Barbarians Unifs (hors finalistes)								
M22	19:00:00	ULB1	17	26	HEVinci	Finale CUP	1	Catteau



Poule A				
	Pts	P+	P-	GA
ULB 1	6	72	0	72
ERM	2	10	-48	-38
HEFF	4	12	-46	-34

Nb de points marqués sur le tournoi

849 points

129 essais

Poule B				
	Pts	P+	P-	GA
HEVinci	6	38	-5	33
ULB 2	4	15	-41	-26
HEH	2	10	-53	-43

Meilleure Joueuse

Rossignol Delphine ULB/BoitsfortRC

Meilleur Joueur

Martin Vancanneyt Hé de Vinci/RCLaHulpe

Poule C				
	Pts	P+	P-	GA
HESpaak	6	62	0	62
HEPHC 2	4	34	-57	-23
KHBO-VIVEF	2	10	-74	-64

CLASSEMENT FINAL	
1er	HEVinci
2ème	ULB1
3ème	UCL
4ème	HESpaak
5ème	HEPHC1
6ème	HEFF
7ème	ERM
8ème	HENALLUX
9ème	HEPHC2
10ème	ULB2
11ème	HEH
12ème	KHBO-VIVEF

Poule D				
	Pts	P+	P-	GA
HEPHC 1	4	63	-28	35
UCL	6	81	-12	69
HENALLUX	2	0	-104	-104

Jeudi 24 avril 2014

Championnat Enseignement Supérieur

INFORMATIONS GENERALES :

- * **Horaire** : de 13h à 19h.
- * **Info**: Compétition sur 2 terrains synthétiques.
10 joueurs minimum par équipe.
Mixité des institutions interdite pour les hommes,
autorisée chez les dames.
Etre en possession de sa carte étudiant,
et de sa carte d'identité.
Cafétéria du club ouverte.
- * **Lieu** : Kituro,
Bloemtuinenlaan 50 bis (Cité des jardins),
1030 Schaerbeek.

INSCRIPTIONS :

En ligne via le lien : <http://www.aseus.be/championnats/details/3671>

Clôture le lundi 21/04/2014 à 16h00.

Attention, clôture anticipative possible sous réserve de disponibilité.

Le responsable sport de ton institution recevra une confirmation de l'inscription par mail.

Inscris-toi sans attendre grâce à ton smartphone et ce QR-CODE !



Résultats du Championnat FSUB de Rugby VII

FD- ASEUS- Kituro

Jeudi 24 avril 2014



Championnat de rugby à 7 - FSUB Dames & Hommes Kituro-Schaerbeek 24/04/2014

	Heures	Domicile			Extérieur	Terrain	Poule	Exempt	Arbitres
Hommes	13:20:00	UCL	25	0	HENLL 2	1	A	Ulg	fft général HENLL 2
Hommes	13:20:00	HEPHC 2	0	31	HEldV 2	2	A		
Hommes	13:40:00	HEldV 1	50	0	HENLL 1	1	B	HEPHC 1	
Hommes	13:40:00	HEFF	5	22	ERM	2	B		
Dames	14:00:00	Ulb	61	0	Ulg (Gx)	1		HEPL	
Dames	14:00:00	UCL	0	25	HEPHC	2			alliance UCL/Ulg Gx
Hommes	14:20:00	UCL	50	5	HEldV 2	1	A	HENLL 2	
Hommes	14:20:00	HEPHC 2	0	49	Ulg	2	A		
Hommes	14:40:00	HEldV 1	50	0	ERM	1	B	HENLL 1	
Hommes	14:40:00	HEFF	14	19	HEPHC 1	2	B		
Dames	15:00:00	Ulb	76	0	HEPHC	1		Ulg	
Dames	15:00:00	UCL	0	25	HEPL	2			alliance UCL/Ulg Gx
Hommes	15:20:00	HEPHC 2	25	0	HENLL 2	1	A	UCL	fft général HENLL 2
Hommes	15:20:00	HEldV 2	14	21	Ulg	2	A		
Hommes	15:40:00	HEFF	19	5	HENLL 1	1	B	HEldV 1	
Hommes	15:40:00	ERM	7	28	HEPHC 1	2	B		
Dames	16:00:00	UCL	0	25	Ulg (Gx)	1		Ulb	alliance UCL/Ulg Gx
Dames	16:00:00	HEPHC	10	19	HEPL	2			
Hommes	16:20:00	UCL	59	0	Ulg	1	A	HEPHC 2	
Hommes	16:20:00	HEldV 2	25	0	HENLL 2	2	A		fft général HENLL 2
Hommes	16:40:00	HEldV 1	52	5	HEPHC 1	1	B	HEFF	
Hommes	16:40:00	ERM	25	0	HENLL 1	2	B		fft HENLL1
Hommes	17:00:00	UCL	25	0	HEPHC 2	1	A	HEldV 2	fft HEPHC 2
Hommes	17:00:00	HENLL 2	0	25	Ulg	2	A		fft général HENLL 2
Hommes	17:20:00	HEldV 1	26	12	HEFF	1	B	ERM	
Hommes	17:20:00	HENLL 1	14	41	HEPHC 1	2	B		
Dames	17:40:00	Ulb	54	0	HEPL	1		UCL	
Dames	17:40:00	HEPHC	21	7	Ulg (Gx)	2			
Hommes	18:00:00	HENLL 2	0	25	HENLL 1	1	Finale 10-9ème		fft général HENLL 2
Hommes	18:00:00	HEPHC 2	0	50	HEFF	2	Finale 8-7ème		
Hommes	18:20:00	HEldV 2	21	14	ERM	1	Finale 6-5ème		
Hommes	18:20:00	Ulg	10	14	HEPHC 1	2	Finale BRONZE (4-3)		
Dames	18:40:00	Ulb	25	0	UCL	1		HEPHC	alliance UCL/Ulg Gx
Dames	18:40:00	Ulg (Gx)	7	20	HEPL	2			
Hommes	19:00:00	UCL	0	31	HELDV 1	1	Finale OR (1er-2nd)		

Dames					
	Pts	GA	P-	P+	Cartons
Ulb	6	216	0	216	
UCL	0	-100	-100	0	
HEPHC	3	158	102	56	
Ulg (Gx)	0	19	-20	39	
HEPL	6	135	71	64	

Hommes					
Poule A	Pts	GA	P-	P+	Cartons
UCL	12	164	5	159	
HEPHC 2	3	68	43	25	
HEldV 2	6	121	71	50	
HENLL 2	0	50	50	0	
Ulg	9	168	73	95	

Poule B	Pts	GA	P-	P+	Cartons
HEldV 1	12	195	17	178	
HEFF	3	78	28	50	1
ERM	6	83	73	10	
HENLL 1	0	54	35	19	3
HEPHC 1	9	152	59	93	

Total des points marqués **Joueuse du tournoi**
1288 **Héloïse Stévins-ULB**

Nombre d'essais marqués **Joueur du tournoi**
222 **Adrien Petit-HEldVinci**

35 matchs

Jeudi 28 novembre 2013

Championnat Enseignement Supérieur

INFORMATIONS GENERALES :

- * **HORAIRE** : dès 17h.
- * **LIEU** : Sportcentrum KU Leuven, grote zaal Gebouw De Nayer, Tervuursevest 101, 3001 Heverlee.
- * **EQUIPEMENT** : T-shirt et short (pas de tenue de couleur blanche).

INSCRIPTIONS :

En ligne via le lien : <http://www.aseus.be/formulaire/2116>

Clôture le vendredi 25/11/2013 à 16h00.

Attention, clôture anticipative possible sous réserve de disponibilités.

Le responsable sport de ton institution recevra une confirmation de ton inscription par mail.

Inscris-toi sans attendre grâce à ton smartphone et ce QR-CODE !



Résultats du Championnat FSUB de TENNIS DE TABLE

KULeuven

Jeudi 28 novembre 2013



Resultaat Belgisch Interuniversitair Tafeltennis Kampioenschap 2013

Plaats	Naam	Voornaam	ranking	Instelling
1	swartenbrouckx	gaetan	B0	HE Charlemagne
2	Bierny	Ludovic	A	KU Leuven
3	LEONARD	KEVIN	B2	HE Libre Mosane
4	Henkens	David	B0	Groep T
5	gielen	jorn	B2	KHLeuven
6	Van den Sanden	Benjamin	B4	HoGent
7	Cluyts	Filip	B2	KU Leuven
8	Goyens	Yves	B2	KU Leuven
9	Beckers	Jimmy	B6	KU Leuven
10	diouf	guillaume-emm	B2	Université Catholique de Louvain
11	Moeys	Sander	B2	KHLeuven
12	Nulens	Simon	C0	Université Catholique de Louvain
13	Ampe	Frederik	C2	UGent
14	Scheers	David	C0	KU Leuven
15	Peulen	Martijn	C4	KU Leuven
16	De Wolf	Jan	NG	KU Leuven
17-32 ZELFDE RANKING				
17-32	De Cuyper	Jeroen	B6	KU Leuven
17-32	LEHNEN	AARON	B6	HE de la Province de Liège
17-32	Willems	James	C2	Groep T
17-32	Berrada-Lamine	Smaïl	C2	Université Catholique de Louvain
17-32	Beckers	Kenny	C0	HUB
17-32	Bonelli	Stefano	C4	VUB
17-32	De Laet	Bruno	C4	KU Leuven
17-32	Arnalsteen	Sven	E4	KHLeuven
17-32	De Meter	Jan	B4	KU Leuven
17-32	Verhelst	Willem	D4	Thomas More Mechelen
17-32	Heylen	Sander	C2	KU Leuven
17-32	Lejeune	Jordane	B2	HE Libre Mosane
17-32	Brasseur	Baptiste	C2	Université Catholique de Louvain
17-32	Ferire	Loïc	B4	HE Libre Mosane
17-32	Derycke	Thomas	B6	Université Catholique de Louvain
17-32	Vyncke	Brecht	B6	UGent
48-67 ZELFDE RANKING				
48-67	Arnouts	Sven	NG	Universiteit Antwerpen
48-67	Augustijns	Milan	NG	KU Leuven
48-67	Coolen	Robin	C4	KU Leuven
48-67	De Ketelbutter	Arne	D6	UGent
48-67	De Wispelaere	Thijs	NG	KU Leuven
48-67	Decock	Gianni	C0	Artevelde Hogeschool
48-67	Descheemaeker	Korneel	C4	UGent
48-67	Folens	Stijn	E0	KU Leuven
48-67	Guilliams	Romain	D0	HE Libre Mosane
48-67	Jacquemin	Sébastien	C2	HE de Namur Liège Luxembourg
48-67	Janssens	Bert	C4	KU Leuven
48-67	Kuppens	Gijs	D0	HoGent
48-67	Lazou	Rutger	D2	UGent

48-67 Lecaillié	Quentin	C6	HE Libre Mosane
48-67 Maes	Jorik	C0	Katholieke Hogeschool Sint-Lieven
48-67 MARRAKCHI	AHMED	E2	Université de Liège (site de Liège)
48-67 Merckx	Pieter	D6	KU Leuven
48-67 Meyers	Mike	C0	Universiteit Hasselt
48-67 Misse	Kevin	E5	HE Libre Mosane
48-67 Moreau	Mathieu	D0	HE Provinciale du Hainaut-Condorcet
48-67 nijskens	Antoine	D0	Université de Namur
48-67 Nys	Daniël	NG	KU Leuven
48-67 Overloop	Bart	D0	KU Leuven
48-67 Paternoster	Maxim	NG	KU Leuven
48-67 Raes	Michiel	C6	KU Leuven
48-67 Ricottone	Giuliano	C4	HE Libre Mosane
48-67 Simons	Glenn	NG	Universiteit Antwerpen
48-67 Truyen	Jorn	NG	KU Leuven
48-67 Van Assche	Toon	D6	KU Leuven
48-67 Van Melkebeke	Sander	C0	KU Leuven
48-67 Vandycke	Stijn	NG	Groep T
48-67 Verhelst	Jeroen	E0	KHLeuven
48-67 Weibel	Steven	D0	HE Libre Mosane
48-67 wijnen	Klaas	NG	KU Leuven
48-67 Willebrords	Jef	E4	KHLeuven

Resultaat Belgisch Interuniversitair Tafeltennis Kampioenschap 2013

Plaats	Naam	Voornaam	Klassement	Instelling
1	Mityukova	Daria	A	Hogeschool PXL
2	Depuydt	Wendel	B0	HoWest
3	overloop	tineke	B4	KU Leuven
4	Baijot	Aur�lie	B6	Universit� Catholique de Louvain
5	Lamproye	Jana	B6	KU Leuven
6	Brebels	An	C0	KU Leuven
7	Julin	Eline	C6	Universiteit Hasselt
8	Szentesi	Anett	NG	HUB
9	Goossens	Jolien	C2	Katholieke Universiteit Leuven
10	Goossens	Sofie	C2	Hogeschool PXL
11	Lamproye	Jolien	C2	Katholieke Universiteit Leuven

Le samedi 30 Novembre 2013 Championnat Enseignement Supérieur

INFORMATIONS GENERALES :

- * **Horaire** : 13h00 départ
- * **Infos** :
 - distance : 12 km
 - plus d'info :
<http://www.aseus.be/championnats/details/3468>
- * **LIEU** :
Enclus Du Haut 53
7750 Mont De L'enclus

INSCRIPTIONS :

En ligne via le lien : <http://www.aseus.be/formulaire/3469>

Clôture le samedi 23/11/2013 à 16h00.

Attention, clôture anticipative possible sous réserve de disponibilité (300 inscrits max.).

Le responsable sport de ton institution recevra une confirmation de ton inscription par mail.

Inscris-toi sans attendre grâce à ton smartphone et ce QR-CODE !



Avec le soutien de :





Sports Quality Time Measuring

ARAGASTRAIL RUN 12KM

Plaats	Borstnr	Naam	Categorie	Ronde 1
1	71	Jannes Cottyn	M Student	0:23:43
2	61	Lukas De Jonghe	M Student	0:23:55
3	125	Raphael AMATO	M	0:24:24
4	101	Jeroen Meul	M	0:25:21
5	117	Robin Decottignies	M	0:25:31
6	353	Nelson Coomans	M Student	0:25:58
7	72	Maxim valcke	M Student	0:26:47
8	88	Donavan Leyn	M Student	0:25:46
9	104	Henk Omey	M	0:25:22
10	211	Sophie De Grootte	V	0:26:52
11	155	Wim Tack	M	0:26:56
12	164	Tom Tanghe	M	0:26:42
13	89	gert cruyt	M Student	0:26:35
14	178	Mr Van Den Driesche	M	0:26:52
15	18	Kris De Rouck	M	0:27:22
16	165	Thomas De Jonghe	M	0:28:27
17	134	Didier Callens	M	0:27:06
18	195	Lieselot Bossuyt	V	0:27:41
19	73	Wouter Tampère	M Student	0:28:04
20	130	Bert Deruyck	M	0:29:55
21	97	Jonathan Kazimoto	M	0:28:20
22	92	Kenneth Lauwers	M Student	0:27:56
23	65	Didier Verlee	M Student	0:28:19
24	175	Sophie Drofiak	V Student	0:29:23
25	131	Falco Defour	M	0:29:55
26	94	Christophe Bittner	M Student	0:29:33
27	136	Marc Tampère	M	0:29:41
28	81	Felix Wyns	M Student	0:29:32
29	153	Ben bonnaerens	M	0:29:48
30	93	Jasper Bonte	M Student	0:30:22
31	161	geert janssens	M	0:31:05
32	80	Tom Wijgaerts	M Student	0:29:40
33	148	yves pugliari	M	0:30:02
34	162	rossignol	M	0:30:20
35	128	Frederik Vrijs	M	0:31:24

663300

BNP 001-6863646-02

IBAN BE32 0016 8636 4602

BIC GEBABEBB

663300BTW BE 0897.691.151

RPR Tongeren

663300Sports Quality Time Measuring



Sports Quality Time Measuring

36	118	Yannick Haemers	M	0:31:16
37	210	charlene ottevaere	V	0:31:02
38	109	Peter Verstraete	M	0:31:47
39	67	Tibbout Van de Walle	M Student	0:30:36
40	102	Jacob Valcke	M	0:31:32
41	75	Karim El Kaddouri	M Student	0:32:22
42	139	Xavier Michels	M	0:32:19
43	169	Karen De Vlaminck	V Student	0:31:56
44	108	Frederik Martens	M	0:31:22
45	152	Gijs De Boeck	M	0:33:06
46	157	Tim Scheire	M	0:34:31
47	98	Peter Toch	M	0:34:02
48	159	Robin Couckuit	M	0:30:16
49	167	Ine Defeyter	V Student	0:32:23
50	112	David Samain	M	0:32:23
51	213	YVON VERKOYEN	V	0:33:29
52	86	Willy Van Waesberghe	M Student	0:32:00
53	163	Louis LANGERAERT	M	0:32:18
54	120	Hendrik Slabbinck	M	0:33:50
55	135	Mark De Beule	M	0:35:39
56	96	Martin Lelie	M	0:37:04
57	113	Peter De Gryse	M	0:33:34
58	168	Carolien De Vlaminck	V Student	0:33:52
59	126	Yen Lonneville-Bosmans	M	0:33:24
60	121	Yves Bailliu	M	0:35:39
61	206	Leen Van Overtveldt	V	0:35:37
62	149	Koen Vuylsteke	M	0:35:42
63	133	jonas saelens	M	0:34:33
64	129	ethel Vandermeiren	V	0:37:32
65	160	Marc De Vos	M	0:36:48
66	215	Suzan Maertens	V	0:35:44
67	151	Christophe Van de Velde	M	0:36:51
68	105	Kenny Huysman	M	0:34:19
69	146	Maarten Tettelin	M	0:34:55
70	190	NATHALIE LEENHOUDER	V	0:40:03
71	110	Mehdi Zagheden	M	0:35:19
72	193	NATHALIE DE MEYER	V	0:36:56
73	127	Filip Vanhede	M	0:37:11

663300

BNP 001-6863646-02

IBAN BE32 0016 8636 4602

BIC GEBABEBB

663300BTW BE 0897.691.151

RPR Tongeren

663300Sports Quality Time Measuring



Sports Quality Time Measuring

74	191	camille Marlier	V	0:37:39
75	344	Ellen De Smet	V	0:38:11
76	197	Liesbet Ver Bruggen	V	0:37:50
77	166	Bart De Weirdt	M	0:38:01
78	177	Hermien Cassiers	V Student	0:38:36
79	106	Tim-Wouter Stockman	M	0:37:17
80	182	Charlien Theuninck	V	0:38:48
81	16	Filip De Ville	M	0:39:22
82	192	Kaatje Jacob	V	0:37:58
83	174	Heather Dobbelaer	V Student	0:37:28
84	119	Albert SORGELOOS	M	0:40:02
85	138	Joachim Hoebeke	M	0:41:20
86	199	Katrien Saerens	V	0:39:06
87	186	Jolien De Clercq	V	0:39:58
88	196	Laurence Cardon	V	0:39:16
89	59	Chloe Van Cauwenbeghe	V	0:39:36
90	189	CISKA THYS	V	0:40:03
91	205	Elke Van Vijle	V	0:40:16
92	156	Sami Bouzeyene	M	0:38:05
93	204	Sofie Tanghe	V	0:41:17
94	207	Ruth Dauwe	V	0:41:18
95	154	Francois Vanderreydt	M	0:42:07
96	209	Indra Leys	V	0:43:20
97	180	Marian Van Damme	V	0:43:01
98	181	Karin De Beule	V	0:43:02
99	84	Nicolas Dewalque	M Student	0:37:30
100	200	Dominika Juzba	V	0:43:21
101	143	Anthony Despae	M	0:43:21

663300

BNP 001-6863646-02

IBAN BE32 0016 8636 4602

BIC GEBABEBB

663300BTW BE 0897.691.151

RPR Tongeren

663300Sports Quality Time Measuring



Sports Quality Time Measuring

Prestatie	Onderwijsinstelling
0:51:08	Katholieke Universiteit Leuven
0:53:20	Hogeschool West-Vlaanderen
0:54:17	
0:55:57	
0:56:31	
0:56:33	Universiteit Gent
0:57:57	Hogeschool Gent
0:58:03	Katholieke Universiteit Leuven
0:58:23	
0:58:54	
0:59:23	
1:00:11	
1:00:13	Katholieke Hogeschool Vives
1:00:33	
1:00:41	
1:01:12	
1:01:22	
1:02:53	
1:03:07	Karel de Grote hogeschool
1:03:29	
1:03:55	
1:03:55	Vrije Universiteit Brussel
1:04:08	Artevelde Hogeschool
1:04:14	HE Louvain en Hainaut
1:04:50	
1:05:58	Katholieke Hogeschool Vives
1:06:09	
1:06:26	Katholieke Universiteit Leuven
1:06:28	
1:06:47	
1:07:13	Universiteit Gent
1:07:22	
1:07:38	Katholieke Universiteit Leuven
1:08:15	
1:08:20	

BNP 001-6863646-02

IBAN BE32 0016 8636 4602

BIC GEBABEBB

663300BTW BE 0897.691.151

RPR Tongeren

663300Sports Quality Time Measuring



Sports Quality Time Measuring

1:08:33

1:08:47

1:09:09

1:09:46

Katholieke Hogeschool Sint-Lieven

1:10:23

1:10:47

Hogeschool Gent

1:11:14

1:11:21

Katholieke Hogeschool Vives

1:12:03

1:12:19

1:12:38

1:13:13

1:13:22

1:14:06

Katholieke Hogeschool Vives

1:14:30

1:15:09

1:15:28

HE Léonard de Vinci

1:15:39

1:15:48

1:16:10

1:17:00

1:17:05

1:18:03

Universiteit Antwerpen

1:18:18

1:18:28

1:18:47

1:18:49

1:19:43

1:20:04

1:20:05

1:20:14

1:20:23

1:20:32

1:21:26

1:21:47

1:21:53

1:22:32

1:22:52

663300

BNP 001-6863646-02

IBAN BE32 0016 8636 4602

BIC GEBABEBB

663300BTW BE 0897.691.151

RPR Tongeren

663300Sports Quality Time Measuring



Sports Quality Time Measuring

1:22:53

1:22:57

1:22:59

1:23:28

1:24:00 Artesis Plantijn Hogeschool Antwerpen

1:24:38

1:25:17

1:25:41

1:25:57

1:26:44 Hogeschool West-Vlaanderen

1:26:56

1:27:07

1:27:08

1:27:12

1:27:14

1:27:47

1:29:14

1:31:22

1:32:24

1:32:26

1:32:36

1:34:01

1:35:33

1:35:49

1:35:49

1:36:18 Universit  Libre de Bruxelles

1:37:11

1:37:11

663300

BNP 001-6863646-02

IBAN BE32 0016 8636 4602

BIC GEBABEBB

663300BTW BE 0897.691.151

RPR Tongeren

663300Sports Quality Time Measuring

Dimanche 18 mai 2014

Championnat Enseignement Supérieur

INFORMATIONS GENERALES :

* Distances : 1500m - 40 km - 10 km (1/4).

* Départ Hommes : 14h30.
Départ Dames : 14h40.

* Lieu : Centre ADEPS «La Marlette»,
Rue de la Marlette, 3 à 7180 Seneffe.
Petite restauration sur place.

INSCRIPTIONS :

En ligne via le lien : <http://www.aseus.be/championnats/details/3671>

Clôture le mercredi 14/05/2014 à 16h00.

Attention, clôture anticipative possible sous réserve de disponibilité.

Le responsable sport de ton institution recevra une confirmation de ton inscription par mail.

Inscris-toi sans attendre grâce à ton smartphone et ce QR-CODE !

Avec le soutien de :



Championnat de Belgique de l'Enseignement Supérieur

Duathlon (18/05/2014 à Senefte)

Résultats Universitaires



Triathlon de Seneffe - Seneffe - Belgique

Championnat de Belgique Universitaire de Duathlon (10km - 40 Km- 5 Km) - 15 mai 2014

Pos	Nr	Licence	Nom	Pos	CAT	Université	Club	Cap1		Trans 1		Velo		Trans 2		Cap2		Total	Gap
								Pos	Temps	Pos	Temps	Pos	Temps	Pos	Temps				
3	122	08629M90	Devliegher Arne	3	M24	KUL Katholieke Universiteit Leuven	MTC	7	00:33'38"	26	00:00'51"	7	01:06'48"	3	00:00'39"	5	00:18'15"	02:00'12"719	+00:01'39"459
11	158	59449M90	Van Dongen-vogels Edouard	10	M24	HEPL HE de la Province de Liège	RCBT	11	00:35'00"	6	00:00'42"	16	01:08'04"	4	00:00'40"	6	00:18'19"	02:02'48"192	+00:04'14"932
15	280	aucun	Depraetere Hannes	1	MU23	Universiteit_Gent	aucun	28	00:36'10"	101	00:01'07"	15	01:07'59"	110	00:01'06"	12	00:19'31"	02:05'55"923	+00:07'22"663
23	3	A08987C024C	Hoeksema Julien	2	MU23	UCLouvain Université Catholique de Louvain	NP3	13	00:35'11"	16	00:00'46"	10	01:07'02"	11	00:00'46"	132	00:25'09"	02:08'55"362	+00:10'22"102
31	306	aucun	Pumelle Marin	3	MU23	UCLouvain Université Catholique de Louvain	aucun	24	00:35'56"	46	00:00'55"	61	01:13'11"	80	00:00'59"	21	00:19'52"	02:10'55"889	+00:12'22"629
33	167	08558M93	Couvreur Kenny	4	MU23	Universiteit_Gent	TBT	51	00:37'55"	54	00:00'58"	31	01:10'42"	27	00:00'49"	40	00:20'45"	02:11'11"563	+00:12'38"303
44	144	56699M93	Bouillet Louis	6	MU23	UCLouvain Université Catholique de Louvain	RCBT	57	00:38'23"	12	00:00'44"	47	01:12'20"	13	00:00'46"	46	00:21'00"	02:13'15"235	+00:14'41"975
64	38	04669M94	Yannick Plaetevoet	8	MU23	Plantijnhogeschool	ATRIC	96	00:40'25"	82	00:01'03"	52	01:12'36"	69	00:00'56"	60	00:21'32"	02:16'34"420	+00:18'01"160
67	303	aucun	Mulpas Cédric	37	M24	UCLouvain Université Catholique de Louvain	aucun	82	00:39'50"	118	00:01'12"	57	01:12'56"	118	00:01'08"	63	00:21'54"	02:17'02"066	+00:18'28"806
77	24	56515M93	Gillain Michael	9	MU23	UCLouvain Université Catholique de Louvain	ATCC	21	00:35'46"	11	00:00'44"	49	01:12'27"	54	00:00'53"	193	00:30'08"	02:20'00"513	+00:21'27"253
79	206	56240m87	Genty Stéphane	43	M24	UCLouvain Université Catholique de Louvain	Tri GT	56	00:38'23"	24	00:00'50"	80	01:14'41"	87	00:01'00"	147	00:26'10"	02:21'05"337	+00:22'32"077
93	118	07584F90	Massagé Birgit	2	F24	Plantijnhogeschool	LT	95	00:40'23"	61	00:00'59"	133	01:20'28"	35	00:00'50"	64	00:21'54"	02:24'36"649	+00:26'03"389
96	297	aucun	Lombart Martin	54	M24	HEL V HE Léonard de Vinci	aucun	71	00:38'58"	44	00:00'55"	129	01:20'00"	46	00:00'52"	114	00:24'27"	02:25'14"045	+00:26'40"785
106	325	aucun	Wyns Felix	12	MU23	KUL Katholieke Universiteit Leuven	aucun	87	00:40'01"	200	00:01'48"	114	01:18'57"	190	00:01'39"	122	00:24'46"	02:27'14"098	+00:28'40"838
112	54	57713M92	Somers Ludovic	14	MU23	UCLouvain Université Catholique de Louvain	BTC	128	00:42'28"	186	00:01'33"	87	01:15'21"	174	00:01'28"	173	00:27'41"	02:28'33"871	+00:30'00"611
115	92	56067F94	Piron Eloïse	1	FU23	ULg Université de Liège (site de Liège)	ESN	130	00:42'45"	40	00:00'54"	150	01:22'07"	5	00:00'41"	80	00:22'49"	02:29'18"999	+00:30'45"739
116	324	aucun	Wijgaerts Tom	15	MU23	KUL Katholieke Universiteit Leuven	aucun	134	00:42'56"	99	00:01'07"	119	01:19'20"	111	00:01'06"	128	00:25'03"	02:29'35"551	+00:31'02"291
118	168	58666M93	Aerts Corentin	16	MU23	UCLouvain Université Catholique de Louvain	TCBM	72	00:39'13"	16	00:00'46"	120	01:19'32"	78	00:00'58"	191	00:30'00"	02:30'31"877	+00:31'58"617
128	125	58643M93	Adant Olivier	18	MU23	UCLouvain Université Catholique de Louvain	NSTT	101	00:40'42"	23	00:00'49"	181	01:26'53"	26	00:00'49"	77	00:22'39"	02:31'55"787	+00:33'22"527
131	219	59557M92	Grosdent Thomas	19	MU23	UCLouvain Université Catholique de Louvain	TRIGT	92	00:40'19"	117	00:01'10"	116	01:19'02"	79	00:00'58"	199	00:31'12"	02:32'43"137	+00:34'09"877
137	151	aucun	Lesecq Antoine	20	MU23	HEL B HE Libre de Bruxelles	RCBT	119	00:41'59"	125	00:01'13"	148	01:21'40"	191	00:01'39"	162	00:26'56"	02:33'29"869	+00:34'56"609
138	216	58590F92	Decaluwe Kelly	2	FU23	HECF H HE de la Communauté Française en Hainaut	TRIGT	145	00:44'00"	48	00:00'57"	153	01:22'33"	113	00:01'07"	138	00:25'26"	02:34'05"856	+00:35'32"596
160	119	04533F95	Rubbrecht Sofie	1	F18	KUL Katholieke Universiteit Leuven	LT	136	00:43'19"	59	00:00'58"	164	01:23'38"	217	00:02'59"	177	00:28'04"	02:39'00"903	+00:40'27"643
177	42	58895F93	De Grootte Estelle	3	FU23	UCLouvain Université Catholique de Louvain	BIN	183	00:47'02"	152	00:01'20"	190	01:29'08"	85	00:01'00"	137	00:25'24"	02:43'55"970	+00:45'22"710
194	295	aucun	Jadot Adélie	4	FU23	UCLouvain Université Catholique de Louvain	aucun	188	00:47'54"	174	00:01'28"	210	01:35'22"	165	00:01'25"	171	00:27'28"	02:53'37"544	+00:55'04"284
196	143	aucun	Renard Christophe	23	MU23	ULg Université de Liège (site de Liège)	RCAE	178	00:46'44"	222	00:03'41"	205	01:32'53"	203	00:01'52"	190	00:29'41"	02:54'53"689	+00:56'20"429
DSQ	112	04990M92	Vanhoutte Witze			MU23	KUL Katholieke Universiteit Leuven	ITC											
DNF	218	59122M87585	Dewalque Nicolas			M24	ULB Université Libre de Bruxelles	Tri GT											
NC	128	57820F75	Platteeuw Véronique			F24	HEPL HE de la Province de Liège	TRIGT	227	02:29'38"									

Championnat de Belgique de l'Enseignement Supérieur

Duathlon (18/05/2014 à Seneffe)

Résultats Généraux



Triathlon de Seneffe - Seneffe - Belgique
Classement duathlon (10km - 40 Km- 5 Km) - 15 mai 2014

Pos	Nr	Licence	Nom	Pos	CAT	Club	Cap1		Trans 1		Velo		Trans 2		Cap2		Total	Gap
							Pos	Temps	Pos	Temps	Pos	Temps	Pos	Temps	Pos	Temps		
1	2	58911M83	Vandiest Thomas	1	M24	RCBT	1	00:32'19"	2	00:00'40"	9	01:06'56"	47	00:00'52"	2	00:17'44"	01:58'33"260	+00:00'00"000
2	5	56244M87	Rolin Boris	2	M24	Tri GT	5	00:33'01"	1	00:00'37"	11	01:07'16"	8	00:00'44"	3	00:17'49"	01:59'29"730	+00:00'56"470
3	122	08629M90	Devliegher Arne	3	M24	MTC	7	00:33'38"	26	00:00'51"	7	01:06'48"	3	00:00'39"	5	00:18'15"	02:00'12"719	+00:01'39"459
4	137	58865M82	Simonet Yves	4	M24	P8	2	00:32'48"	39	00:00'54"	20	01:08'49"	60	00:00'54"	1	00:17'24"	02:00'50"454	+00:02'17"194
5	208	57780M81	Rosu Michael	5	M24	Tri GT	4	00:32'50"	9	00:00'43"	8	01:06'55"	6	00:00'43"	29	00:20'10"	02:01'23"063	+00:02'49"803
6	207	56930M89	Kestelyn Baptiste	6	M24	Tri GT	10	00:34'38"	3	00:00'40"	6	01:06'24"	2	00:00'38"	17	00:19'42"	02:02'03"612	+00:03'30"352
7	72		Berlage Lucky	1	M40	CXL.6	19	00:35'37"	114	00:01'10"	5	01:06'03"	76	00:00'57"	8	00:18'33"	02:02'21"642	+00:03'48"382
8	37	59225M89	Vuegen Ludovic	7	M24	ATCC	27	00:36'10"	20	00:00'48"	3	01:05'49"	21	00:00'48"	9	00:18'47"	02:02'24"434	+00:03'51"174
9	11	00327M78	Huyberechts Dirk	8	M24	3CT	20	00:35'43"	88	00:01'04"	4	01:05'58"	53	00:00'53"	10	00:18'52"	02:02'32"354	+00:03'59"094
10	176	57461M78	Fouss François	9	M24	TCDM	16	00:35'23"	60	00:00'58"	12	01:07'33"	38	00:00'51"	4	00:17'53"	02:02'40"645	+00:04'07"385
11	158	59449M90	Van Dongen-vogels Edouard	10	M24	RCBT	11	00:35'00"	6	00:00'42"	16	01:08'04"	4	00:00'40"	6	00:18'19"	02:02'48"192	+00:04'14"932
12	15	58325M82	Benoit Thomas	11	M24	ATCC	3	00:32'48"	107	00:01'08"	25	01:09'44"	14	00:00'47"	7	00:18'22"	02:02'51"915	+00:04'18"655
13	1	58084M86	Montois Guillaume	12	M24	NSTT	12	00:35'11"	42	00:00'55"	13	01:07'40"	15	00:00'47"	15	00:19'33"	02:04'07"200	+00:05'33"940
14	315	aucun	Van Overmeire Jeroen	13	M24	aucun	23	00:35'49"	74	00:01'01"	19	01:08'25"	67	00:00'55"	13	00:19'32"	02:05'44"467	+00:07'11"207
15	280	aucun	Depraetere Hannes	1	MU23	aucun	28	00:36'10"	101	00:01'07"	15	01:07'59"	110	00:01'06"	12	00:19'31"	02:05'55"923	+00:07'22"663
16	320		Vandevoorde Ruben	14	M24	aucun	22	00:35'48"	51	00:00'57"	22	01:09'18"	7	00:00'43"	16	00:19'39"	02:06'27"703	+00:07'54"443
17	120	02434M64	Vanassche Marc	1	M50	LTTL	41	00:37'19"	22	00:00'49"	14	01:07'54"	58	00:00'53"	19	00:19'46"	02:06'42"902	+00:08'09"642
18	214	58501M95	Bara Paul	1	M18	TRIGT	9	00:34'05"	15	00:00'46"	38	01:11'15"	9	00:00'44"	23	00:19'59"	02:06'50"614	+00:08'17"354
19	140	57773M88	Hastir Julien	15	M24	PMX	33	00:36'38"	71	00:01'00"	21	01:09'00"	56	00:00'53"	18	00:19'42"	02:07'15"986	+00:08'42"726
20	234	00861M74	Laureyns Peter	2	M40	UTO	48	00:37'52"	43	00:00'55"	17	01:08'13"	51	00:00'53"	20	00:19'47"	02:07'41"192	+00:09'07"932
21	43	58914M79	Klavins Gatis	16	M24	BIN	30	00:36'18"	150	00:01'19"	23	01:09'29"	88	00:01'00"	25	00:20'03"	02:08'11"545	+00:09'38"285
22	466	58682M84	Van Liefveringe Axel	17	M24	TRIGT	6	00:33'35"	8	00:00'43"	55	01:12'45"	18	00:00'47"	48	00:21'03"	02:08'55"361	+00:10'22"101
23	3	A08987C0240145MS1FRA	Hoeksema Julien	2	MU23	NP3	13	00:35'11"	16	00:00'46"	10	01:07'02"	11	00:00'46"	132	00:25'09"	02:08'55"362	+00:10'22"102
24	236	0190107MV1FRA	Blondeau Benoit	3	M40	Valenciennes Triathlon	25	00:36'02"	73	00:01'01"	27	01:09'49"	134	00:01'12"	42	00:20'55"	02:09'01"853	+00:10'28"593
25	172	59211M86	Chevalier Benoit	18	M24	TCDM	15	00:35'22"	17	00:00'47"	43	01:12'01"	16	00:00'47"	26	00:20'06"	02:09'05"163	+00:10'31"903
26	282	07310M79	Despriet Frederik	19	M24		44	00:37'25"	92	00:01'05"	24	01:09'34"	109	00:01'06"	30	00:20'12"	02:09'22"841	+00:10'49"581
27	115	00890M76	Léaucour Bart	20	M24	LENTRIAC	36	00:36'48"	102	00:01'07"	35	01:11'03"	20	00:00'48"	27	00:20'06"	02:09'55"553	+00:11'22"293
28	6	56648M64	Claisse Joel	2	M50	TRIGT	45	00:37'26"	41	00:00'55"	32	01:10'47"	34	00:00'50"	24	00:20'03"	02:10'02"252	+00:11'28"992
29	52	58246M81	Liekens Johan	21	M24	BTC	29	00:36'11"	110	00:01'09"	54	01:12'40"	55	00:00'53"	11	00:19'28"	02:10'22"578	+00:11'49"318
30	21	59079m76	De Vos Erwin	22	M24	ATCC	37	00:36'50"	45	00:00'55"	26	01:09'47"	19	00:00'48"	69	00:22'07"	02:10'30"602	+00:11'57"342
31	306	aucun	Purnelle Marin	3	MU23	aucun	24	00:35'56"	46	00:00'55"	61	01:13'11"	80	00:00'59"	21	00:19'52"	02:10'55"889	+00:12'22"629
32	55	58482M71	Visdeloup Vincent	4	M40	BTC	35	00:36'48"	13	00:00'44"	59	01:13'01"	52	00:00'53"	14	00:19'33"	02:11'00"998	+00:12'27"738
33	167	08558M93	Couvreur Kenny	4	MU23	TBT	51	00:37'55"	54	00:00'58"	31	01:10'42"	27	00:00'49"	40	00:20'45"	02:11'11"563	+00:12'38"303
34	460	00959F73	Geldhof Ilse	1	F40	ETZ	52	00:37'57"	7	00:00'43"	33	01:10'48"	42	00:00'51"	49	00:21'03"	02:11'24"539	+00:12'51"279
35	192	A12156C	Maurer Michael	23	M24	TGV54	50	00:37'54"	86	00:01'03"	41	01:11'45"	41	00:00'51"	22	00:19'57"	02:11'33"089	+00:12'59"829
36	461	01460M87	Diederik Derijcke	24	M24	ETZ	32	00:36'22"	14	00:00'45"	68	01:13'54"	86	00:01'00"	28	00:20'10"	02:12'13"285	+00:13'40"025
37	222	56968M70	Messiaen Xavier	5	M40	TRIGT	43	00:37'23"	35	00:00'53"	42	01:11'50"	157	00:01'23"	41	00:20'55"	02:12'26"561	+00:13'53"301
38	64	58369M67	Hocquet Patrice	6	M40	CCSTC	47	00:37'42"	56	00:00'58"	51	01:12'35"	24	00:00'49"	35	00:20'26"	02:12'31"419	+00:13'58"159
39	275	aucun	Dalaiden Quentin	5	MU23	aucun	34	00:36'48"	89	00:01'04"	53	01:12'39"	57	00:00'53"	50	00:21'11"	02:12'37"519	+00:14'04"259
40	240	05573M67	De Jaeger Luc	7	M40	WTDT	59	00:38'27"	27	00:00'51"	37	01:11'10"	25	00:00'49"	57	00:21'24"	02:12'44"198	+00:14'10"938
41	311	aucun	Suray Damien	25	M24		69	00:38'57"	36	00:00'53"	18	01:08'24"	45	00:00'52"	97	00:23'42"	02:12'50"939	+00:14'17"679
42	217	58213M71	Depoorter Xavier	8	M40	TRIGT	55	00:38'04"	94	00:01'06"	39	01:11'17"	65	00:00'55"	59	00:21'29"	02:12'52"614	+00:14'19"354

43	22	56250M67	Didier William	9 M40	ATCC	26	00:36'08"	77	00:01'01"	29	01:10'33"	63	00:00'54"	116	00:24'28"	02:13'06"778	+00:14'33"518
44	144	56699M93	Bouillet Louis	6 MU23	RCBT	57	00:38'23"	12	00:00'44"	47	01:12'20"	13	00:00'46"	46	00:21'00"	02:13'15"235	+00:14'41"975
45	97	56249M76	Verrue Vincent	26 M24	FLOT	38	00:36'56"	141	00:01'16"	65	01:13'47"	99	00:01'03"	33	00:20'19"	02:13'23"051	+00:14'49"791
46	235	05277M85	Wouters Patrick	27 M24	UTO	49	00:37'54"	69	00:01'00"	62	01:13'21"	40	00:00'51"	34	00:20'23"	02:13'31"364	+00:14'58"104
47	302	aucun	Mariella Claudio	28 M24	aucun	70	00:38'57"	49	00:00'57"	30	01:10'38"	32	00:00'49"	74	00:22'35"	02:13'58"182	+00:15'24"922
48	76	58723M92	Territo Joakim	7 MU23	EGZA3T	31	00:36'19"	50	00:00'57"	91	01:15'52"	61	00:00'54"	32	00:20'16"	02:14'20"906	+00:15'47"646
49	12	00195M67	Kivern Frank	10 M40	3CT	65	00:38'44"	124	00:01'13"	50	01:12'28"	66	00:00'55"	52	00:21'14"	02:14'36"352	+00:16'03"092
50	90	57552M66	Dejong Daniel	11 M40	ESN	80	00:39'41"	129	00:01'14"	28	01:10'28"	114	00:01'07"	70	00:22'09"	02:14'42"990	+00:16'09"730
51	152	58653M87	Petteau Adrien	29 M24	RCBT	75	00:39'19"	37	00:00'53"	60	01:13'07"	10	00:00'45"	39	00:20'41"	02:14'48"284	+00:16'15"024
52	4	56492M78	Bourguet Benoit	30 M24	TRIGT	8	00:34'04"	5	00:00'42"	100	01:17'07"	62	00:00'54"	66	00:22'01"	02:14'51"096	+00:16'17"836
53	198	59355M68	Grandjean Benoit	12 M40	TNT	39	00:37'00"	167	00:01'24"	79	01:14'34"	138	00:01'14"	43	00:20'55"	02:15'09"291	+00:16'36"031
54	80	58849M79	Denoz Maxime	31 M24	ENERGY	114	00:41'21"	162	00:01'22"	34	01:10'56"	71	00:00'56"	38	00:20'36"	02:15'14"358	+00:16'41"098
55	287	aucun	Geuens Stijn	32 M24	aucun	46	00:37'36"	136	00:01'16"	86	01:15'14"	70	00:00'56"	31	00:20'15"	02:15'19"030	+00:16'45"770
56	26	56852M74	Hubert Pierre	13 M40	ATCC	62	00:38'42"	29	00:00'51"	74	01:14'27"	37	00:00'51"	36	00:20'28"	02:15'21"595	+00:16'48"335
57	66	58685M85	Leblanc Renaud	33 M24	CCSTC	18	00:35'32"	10	00:00'44"	84	01:15'02"	33	00:00'50"	90	00:23'19"	02:15'28"563	+00:16'55"303
58	136	58258M67	Rodrique Emmanuel	14 M40	P8	60	00:38'30"	93	00:01'06"	75	01:14'29"	77	00:00'58"	37	00:20'36"	02:15'40"824	+00:17'07"564
59	47	56300M83	Caruso Matteo	34 M24	BTC	110	00:41'19"	163	00:01'24"	36	01:11'07"	98	00:01'02"	47	00:21'01"	02:15'55"155	+00:17'21"895
60	27	58953M82	Impens Nicolas	35 M24	ATCC	64	00:38'42"	66	00:00'59"	73	01:14'25"	90	00:01'01"	44	00:20'57"	02:16'06"941	+00:17'33"681
61	30	58313M80	Minette Sébastien	36 M24	ATCC	63	00:38'42"	18	00:00'47"	77	01:14'34"	23	00:00'48"	53	00:21'17"	02:16'10"849	+00:17'37"589
62	16	59266M70	Blancke Hugues	15 M40	ATCC	91	00:40'14"	64	00:00'59"	46	01:12'14"	115	00:01'07"	61	00:21'35"	02:16'12"586	+00:17'39"326
63	113	05557F87	Weuts Karolien	1 F24	ITC	58	00:38'23"	21	00:00'49"	83	01:15'01"	17	00:00'47"	55	00:21'18"	02:16'21"011	+00:17'47"751
64	38	04669M94	Yannick Plaetevoet	8 MU23	ATRIC	96	00:40'25"	82	00:01'03"	52	01:12'36"	69	00:00'56"	60	00:21'32"	02:16'34"420	+00:18'01"160
65	102	57611M67	Delmay Daniel	16 M40	HTT	78	00:39'33"	91	00:01'04"	58	01:12'59"	106	00:01'05"	67	00:22'05"	02:16'48"896	+00:18'15"636
66	211	USAT 2100019890	Acuilas Jean-yves	17 M40	TRIFAST	102	00:40'44"	79	00:01'02"	44	01:12'11"	74	00:00'56"	65	00:21'58"	02:16'53"279	+00:18'20"019
67	303	aucun	Mulpas Cédric	37 M24	aucun	82	00:39'50"	118	00:01'12"	57	01:12'56"	118	00:01'08"	63	00:21'54"	02:17'02"066	+00:18'28"806
68	465	A08887C01900124MV1FRA	Moisson Jean Francois	18 M40	team triathlon maubeuge	77	00:39'30"	80	00:01'02"	64	01:13'36"	72	00:00'56"	68	00:22'07"	02:17'13"522	+00:18'40"262
69	28	59343M88	Lechanteur Jeremy	38 M24	ATCC	99	00:40'41"	34	00:00'53"	48	01:12'21"	50	00:00'52"	83	00:23'00"	02:17'49"935	+00:19'16"675
70	170	57897M73	Bousmanne Marc	19 M40	TCDM	40	00:37'01"	38	00:00'54"	94	01:16'22"	84	00:00'59"	85	00:23'04"	02:18'22"502	+00:19'49"242
71	109	56721M68	Dufrane Gil	20 M40	HTTT	84	00:39'56"	138	00:01'16"	56	01:12'49"	101	00:01'03"	93	00:23'22"	02:18'28"933	+00:19'55"673
72	310	59678m88	Serwy Florian	39 M24	PDO team	42	00:37'22"	55	00:00'58"	89	01:15'40"	146	00:01'16"	92	00:23'22"	02:18'39"809	+00:20'06"549
73	20	58023M72	De Clercq Jean-fabien	21 M40	ATCC	90	00:40'12"	30	00:00'51"	88	01:15'36"	119	00:01'08"	51	00:21'14"	02:19'03"319	+00:20'30"059
74	191	0160195MS4FRA	Biancalani Ludovic	40 M24	TGV54	67	00:38'49"	95	00:01'06"	71	01:14'23"	12	00:00'46"	108	00:24'15"	02:19'22"735	+00:20'49"475
75	145	aucun	Crebbin Tom	3 M50	RCBT	98	00:40'41"	148	00:01'19"	45	01:12'13"	126	00:01'11"	112	00:24'24"	02:19'48"851	+00:21'15"591
76	289	aucun	Godeau Samuel	41 M24	aucun	68	00:38'56"	98	00:01'07"	69	01:14'05"	44	00:00'52"	127	00:24'58"	02:19'59"520	+00:21'26"260
77	24	56515M93	Gillain Michael	9 MU23	ATCC	21	00:35'46"	11	00:00'44"	49	01:12'27"	54	00:00'53"	193	00:30'08"	02:20'00"513	+00:21'27"253
78	194	58206M87	Buffet Kevin	42 M24	TNT	109	00:41'14"	28	00:00'51"	96	01:16'44"	39	00:00'51"	54	00:21'18"	02:21'00"601	+00:22'27"341
79	206	56240m87	Genty Stéphane	43 M24	Tri GT	56	00:38'23"	24	00:00'50"	80	01:14'41"	87	00:01'00"	147	00:26'10"	02:21'05"337	+00:22'32"077
80	156	59595m87	Seha Matthieu	44 M24	RCBT	53	00:38'00"	90	00:01'04"	104	01:17'16"	59	00:00'54"	104	00:23'59"	02:21'15"509	+00:22'42"249
81	116	07471M76	Soenen Nico	45 M24	lentriac vtld	120	00:42'00"	142	00:01'17"	85	01:15'09"	68	00:00'55"	62	00:21'52"	02:21'16"213	+00:22'42"953
82	196	58921M77	Dans Pierre	46 M24	TNT	79	00:39'35"	100	00:01'07"	107	01:18'00"	112	00:01'06"	58	00:21'27"	02:21'17"825	+00:22'44"565
83	202	56256M66	Spits Vincent	22 M40	TNT	111	00:41'19"	120	00:01'12"	66	01:13'48"	133	00:01'12"	98	00:23'48"	02:21'22"829	+00:22'49"569
84	121	0190124MS1FRA	Kruhelski Fabien	47 M24	maubeuge	94	00:40'23"	179	00:01'29"	72	01:14'24"	150	00:01'18"	121	00:24'41"	02:22'16"942	+00:23'43"682
85	67	59552M85	Lelièvre-damit Julien	48 M24	CCSTC	83	00:39'55"	159	00:01'21"	102	01:17'12"	155	00:01'21"	76	00:22'37"	02:22'29"101	+00:23'55"841
86	210	05611M82	Leuwers Peter	49 M24	Triathlon Team leper	124	00:42'13"	160	00:01'22"	78	01:14'34"	144	00:01'16"	94	00:23'24"	02:22'51"516	+00:24'18"256
87	209	07516M70	Schoonbaert Fangio	23 M40	triathlon club damme	122	00:42'10"	193	00:01'37"	70	01:14'19"	196	00:01'45"	91	00:23'19"	02:23'13"351	+00:24'40"091
88	197	57720M82	Delwiche Luc	50 M24	TNT	81	00:39'50"	25	00:00'50"	63	01:13'31"	29	00:00'49"	180	00:28'22"	02:23'24"413	+00:24'51"153
89	60	58602M65	Blondelle Robert	24 M40	CCSTC	126	00:42'19"	158	00:01'21"	92	01:15'59"	132	00:01'12"	75	00:22'35"	02:23'29"851	+00:24'56"591
90	88	56583M79	Servais David	51 M24	ENERGY TRI	129	00:42'32"	52	00:00'58"	110	01:18'23"	43	00:00'52"	56	00:21'24"	02:24'10"276	+00:25'37"016
91	75	04206M64	De Lannoy Didier	4 M50	DVB	125	00:42'16"	194	00:01'37"	76	01:14'32"	176	00:01'28"	110	00:24'20"	02:24'15"589	+00:25'42"329
92	150	59162M93	Gruwez Gilles	10 MU23	RCBT	61	00:38'32"	203	00:01'49"	126	01:19'50"	81	00:00'59"	86	00:23'06"	02:24'18"133	+00:25'44"873

93	118 07584F90	Massagé Birgit	2 F24	LT	95	00:40'23"	61	00:00'59"	133	01:20'28"	35	00:00'50"	64	00:21'54"	02:24'36"	649	+00:26'03"	389
94	177 56718M77	Leclercq Bruno	52 M24	TCDM	86	00:39'58"	146	00:01'18"	111	01:18'35"	129	00:01'12"	96	00:23'31"	02:24'36"	743	+00:26'03"	483
95	49 56693M87	Deveziaux De Lavergne Jean-marie	53 M24	BTC	112	00:41'21"	169	00:01'24"	109	01:18'18"	92	00:01'01"	81	00:22'54"	02:25'01"	205	+00:26'27"	945
96	297 aucun	Lombart Martin	54 M24	aucun	71	00:38'58"	44	00:00'55"	129	01:20'00"	46	00:00'52"	114	00:24'27"	02:25'14"	045	+00:26'40"	785
97	57 58275M78	Bailly Jeffrey	55 M24	CCSTC	89	00:40'11"	168	00:01'24"	112	01:18'46"	172	00:01'26"	95	00:23'31"	02:25'20"	020	+00:26'46"	760
98	10 57890F89	Bastien Céline	3 F24	CCSTC	116	00:41'27"	104	00:01'08"	118	01:19'17"	31	00:00'49"	78	00:22'41"	02:25'24"	517	+00:26'51"	257
99	281 aucun	Descamps Arnaud	11 MU23	aucun	76	00:39'29"	185	00:01'32"	90	01:15'47"	205	00:01'56"	160	00:26'52"	02:25'38"	548	+00:27'05"	288
100	29 56888M72	Lietard Laurent	25 M40	ATCC	153	00:44'31"	132	00:01'15"	93	01:16'11"	91	00:01'01"	79	00:22'47"	02:25'48"	597	+00:27'15"	337
101	108 56081M68	Valet Olivier	26 M40	HTT	121	00:42'02"	53	00:00'58"	106	01:17'34"	36	00:00'50"	117	00:24'29"	02:25'56"	103	+00:27'22"	843
102	107 57509m58	Ortega-torres Enrique	5 M50	HTT	105	00:40'50"	72	00:01'00"	135	01:20'44"	100	00:01'03"	71	00:22'20"	02:25'58"	998	+00:27'25"	738
103	464 A08837C0190124MV2FRA	Gibon Frederic	27 M40	team triathlon maubeuge	100	00:40'42"	76	00:01'01"	139	01:21'05"	117	00:01'08"	72	00:22'27"	02:26'25"	216	+00:27'51"	956
104	195 56155M62	Burrion Paul-henri	6 M50	TNT	118	00:41'42"	65	00:00'59"	117	01:19'14"	48	00:00'52"	106	00:24'09"	02:26'58"	260	+00:28'05"	000
105	50 59197M81	Hony Florent	56 M24	BTC	106	00:40'56"	154	00:01'21"	105	01:17'17"	159	00:01'23"	146	00:26'04"	02:27'03"	284	+00:28'30"	024
106	325 aucun	Wyns Felix	12 MU23	aucun	87	00:40'01"	200	00:01'48"	114	01:18'57"	190	00:01'39"	122	00:24'46"	02:27'14"	098	+00:28'40"	838
107	132 57339M57	Meyrant Philippe	7 M50	OTC	117	00:41'29"	70	00:01'00"	140	01:21'09"	88	00:01'00"	82	00:22'56"	02:27'36"	388	+00:29'03"	128
108	14 0180411MV1FRA	Emptaz Bruno	28 M40	AS Muret triathlon	74	00:39'17"	208	00:01'53"	155	01:22'50"	162	00:01'24"	73	00:22'30"	02:27'55"	453	+00:29'22"	193
109	184 57391M79 5829	Evrard Jean-francois	57 M24	TDCH	88	00:40'04"	81	00:01'02"	172	01:24'32"	154	00:01'21"	45	00:20'58"	02:27'58"	822	+00:29'25"	562
110	71 56217M89	Van Lerberghe Nicolas	58 M24	CCSTC	104	00:40'49"	62	00:00'59"	108	01:18'01"	108	00:01'05"	164	00:27'14"	02:28'11"	126	+00:29'37"	866
111	193 58667m94	Gerin Jason	13 MU23	TITAN	93	00:40'23"	103	00:01'07"	134	01:20'30"	73	00:00'56"	134	00:25'19"	02:28'17"	433	+00:29'44"	173
112	54 57713M92	Somers Ludovic	14 MU23	BTC	128	00:42'28"	186	00:01'33"	87	01:15'21"	174	00:01'28"	173	00:27'41"	02:28'33"	871	+00:30'00"	611
113	269 aucun	Auricchio Emmanuel	59 M24	aucun	73	00:39'16"	192	00:01'37"	141	01:21'20"	168	00:01'25"	131	00:25'05"	02:28'45"	472	+00:30'12"	212
114	34 57424M65	Simoens Gaëtan	29 M40	ATCC	115	00:41'23"	135	00:01'16"	138	01:20'57"	131	00:01'12"	103	00:23'58"	02:28'48"	470	+00:30'15"	210
115	92 56067F94	Piron Eloise	1 FU23	ESN	130	00:42'45"	40	00:00'54"	150	01:22'07"	5	00:00'41"	80	00:22'49"	02:29'18"	999	+00:30'45"	739
116	324 aucun	Wijgaerts Tom	15 MU23	aucun	134	00:42'56"	99	00:01'07"	119	01:19'20"	111	00:01'06"	128	00:25'03"	02:29'35"	551	+00:31'02"	291
117	204 56210M72	Belkhatay Ghandhi	30 M40	Tri GT	66	00:38'47"	33	00:00'52"	103	01:17'15"	94	00:01'01"	203	00:32'04"	02:30'01"	440	+00:31'28"	180
118	168 58666M93	Aerts Corentin	16 MU23	TCBM	72	00:39'13"	16	00:00'46"	120	01:19'32"	78	00:00'58"	191	00:30'00"	02:30'31"	877	+00:31'58"	617
119	298 aucun	Maerschcalcke Philippe	31 M40	aucun	148	00:44'04"	128	00:01'14"	97	01:16'55"	96	00:01'02"	166	00:27'18"	02:30'35"	910	+00:32'02"	650
120	233 03087M73	Feyaerts Jan	32 M40	UTO	168	00:45'55"	123	00:01'13"	101	01:17'08"	171	00:01'26"	126	00:24'54"	02:30'38"	846	+00:32'05"	586
121	62 57629m63	Guerreau Maurice	8 M50	CCSTC	135	00:43'02"	145	00:01'17"	113	01:18'51"	173	00:01'27"	150	00:26'25"	02:31'04"	051	+00:32'30"	791
122	134 56978m72	Gruslin Jules	33 M40	P8	107	00:40'58"	161	00:01'22"	174	01:24'34"	103	00:01'04"	87	00:23'07"	02:31'07"	236	+00:32'33"	976
123	183 56175M55	Defosse Jean-marie	9 M50	TDCH	151	00:44'24"	134	00:01'15"	125	01:19'48"	124	00:01'10"	119	00:24'35"	02:31'15"	217	+00:32'41"	957
124	7 58002F63	Theate Françoise	1 F50	Tri GT	97	00:40'27"	78	00:01'02"	168	01:24'06"	128	00:01'11"	115	00:24'27"	02:31'15"	392	+00:32'42"	132
125	155 58971M73	Schoonjans Michel	34 M40	RCBT	108	00:41'12"	211	00:02'02"	156	01:22'58"	185	00:01'34"	100	00:23'51"	02:31'40"	630	+00:33'07"	370
126	154 59406M72	Remy Sébastien	35 M40	RCBT	138	00:43'30"	197	00:01'40"	142	01:21'24"	121	00:01'09"	101	00:23'56"	02:31'40"	712	+00:33'07"	452
127	148 59161M93	Ghomraoui Bilal	17 MU23	RCBT	161	00:45'34"	119	00:01'12"	81	01:14'43"	120	00:01'08"	186	00:29'00"	02:31'40"	796	+00:33'07"	536
128	125 58643M93	Adant Olivier	18 MU23	NSTT	101	00:40'42"	23	00:00'49"	181	01:26'53"	26	00:00'49"	77	00:22'39"	02:31'55"	787	+00:33'22"	527
129	61 59299m81	Brison Christophe	60 M24	CCSTC	141	00:43'37"	130	00:01'15"	121	01:19'44"	160	00:01'23"	148	00:26'14"	02:32'15"	389	+00:33'42"	129
130	312 56739F88	Swertvaegher Maëlle	4 F24	aucun	154	00:44'33"	151	00:01'20"	131	01:20'07"	201	00:01'49"	124	00:24'51"	02:32'40"	935	+00:34'07"	675
131	219 59557M92	Grosdent Thomas	19 MU23	TRIGT	92	00:40'19"	117	00:01'10"	116	01:19'02"	79	00:00'58"	199	00:31'12"	02:32'43"	137	+00:34'09"	877
132	290 aucun	Gosseau Marc	10 M50	aucun	150	00:44'16"	215	00:02'14"	132	01:20'16"	207	00:01'58"	102	00:23'58"	02:32'44"	048	+00:34'10"	788
133	321 64A25623M000	Vangeel Bart	11 M50	aucun	158	00:45'13"	171	00:01'26"	128	01:20'00"	141	00:01'15"	133	00:25'12"	02:33'07"	971	+00:34'34"	711
134	68 59551M85	Masson Christophe	61 M24	CCSTC	132	00:42'54"	175	00:01'28"	170	01:24'30"	142	00:01'15"	84	00:23'01"	02:33'10"	659	+00:34'37"	399
135	201 57715M85	Pibre Nicolas	62 M24	TNT	147	00:44'03"	57	00:00'58"	137	01:20'54"	64	00:00'55"	153	00:26'28"	02:33'20"	461	+00:34'47"	201
136	146 58616m64	Crefcoeur Philippe	12 M50	RCBT	164	00:45'50"	67	00:01'00"	127	01:19'58"	82	00:00'59"	140	00:25'38"	02:33'27"	367	+00:34'54"	107
137	151 aucun	Lesecq Antoine	20 MU23	RCBT	119	00:41'59"	125	00:01'13"	148	01:21'40"	191	00:01'39"	162	00:26'56"	02:33'29"	869	+00:34'56"	609
138	216 58590F92	Decaluwe Kelly	2 FU23	TRIGT	145	00:44'00"	48	00:00'57"	153	01:22'33"	113	00:01'07"	138	00:25'26"	02:34'05"	856	+00:35'32"	596
139	188 02-21541-0061088-1972	Nieswand Marcus	36 M40	Team Baier Landshut e.1	173	00:46'18"	195	00:01'38"	99	01:17'03"	180	00:01'32"	175	00:27'49"	02:34'21"	851	+00:35'48"	591
140	301 aucun	Marchal Charles	63 M24	aucun	157	00:45'06"	121	00:01'12"	146	01:21'31"	192	00:01'42"	125	00:24'52"	02:34'25"	449	+00:35'52"	189
141	45 58086M71	Mariani Davide	37 M40	Brussels Triathlon Club	167	00:45'53"	155	00:01'21"	123	01:19'44"	210	00:02'08"	135	00:25'21"	02:34'29"	854	+00:35'56"	594
142	186 56318M56	Ladang Michel	13 M50	TDCH	159	00:45'16"	164	00:01'24"	152	01:22'13"	193	00:01'42"	107	00:24'10"	02:34'47"	326	+00:36'14"	066

143	129	11111m11	Simonet Patrick	38	M40	NSTT	166	00:45'52"	172	00:01'27"	147	01:21'38"	156	00:01'22"	120	00:24'39"	02:34'59"382	+00:36'26"122
144	91	59375M90	Mathéi Edwin	64	M24	ESN	123	00:42'12"	113	00:01'09"	165	01:23'39"	143	00:01'16"	159	00:26'49"	02:35'08"231	+00:36'34"971
145	187	59674M81	Martin Virseda Nicolas	65	M24	TDCH	113	00:41'21"	202	00:01'49"	171	01:24'31"	182	00:01'33"	145	00:26'04"	02:35'21"217	+00:36'47"957
146	32	59626M89	Quertinmont Alexandre	66	M24	ATCC	143	00:43'45"	127	00:01'14"	160	01:23'21"	30	00:00'49"	154	00:26'37"	02:35'48"945	+00:37'15"685
147	94	59145M76	Cauchie César	67	M24	ETC	133	00:42'55"	182	00:01'30"	159	01:23'13"	206	00:01'56"	151	00:26'26"	02:36'02"117	+00:37'28"857
148	224	aucun	Colin Jérôme	21	MU23	TTB	175	00:46'30"	165	00:01'24"	115	01:18'59"	75	00:00'57"	181	00:28'30"	02:36'22"567	+00:37'49"307
149	459	07929F87	Solette Lien	5	F24	ETZ	137	00:43'23"	32	00:00'52"	183	01:27'15"	49	00:00'52"	130	00:25'05"	02:37'28"868	+00:38'56"608
150	294		Hubert Rachel	6	F24	aucun	140	00:43'34"	181	00:01'29"	186	01:27'58"	145	00:01'16"	89	00:23'16"	02:37'35"899	+00:39'02"639
151	17	58498M94	Brandl Frédéric	22	MU23	ATCC	202	00:49'52"	47	00:00'56"	95	01:16'31"	137	00:01'13"	187	00:29'06"	02:37'40"086	+00:39'06"826
152	212	USAT 2100019891	Dieudonne Anne	2	F40	TRIFAST	152	00:44'25"	157	00:01'21"	182	01:26'54"	152	00:01'19"	105	00:24'01"	02:38'02"861	+00:39'29"601
153	181	59292M78	Naizy Gaetan	68	M24	TCDM	149	00:44'09"	108	00:01'08"	185	01:27'24"	130	00:01'12"	109	00:24'18"	02:38'13"584	+00:39'40"324
154	31	58959M58	Nerrinck Philippe	14	M50	ATCC	192	00:48'17"	210	00:01'59"	124	01:19'45"	184	00:01'34"	157	00:26'46"	02:38'22"641	+00:39'49"381
155	99	56505M66	Cooremans Guy	39	M40	GTC	156	00:45'01"	177	00:01'28"	158	01:23'09"	148	00:01'17"	172	00:27'32"	02:38'29"485	+00:39'56"225
156	316		Van Overtveldt Leen	7	F24	aucun	184	00:47'24"	83	00:01'03"	157	01:23'01"	102	00:01'04"	142	00:25'58"	02:38'31"334	+00:39'58"074
157	25	aucun	Heneffe Martin	2	M18	ATCC	155	00:44'38"	131	00:01'15"	178	01:25'29"	139	00:01'14"	143	00:26'03"	02:38'41"643	+00:40'08"383
158	299	58379M54	Maghe Michel	1	M60	ATCC	174	00:46'26"	63	00:00'59"	161	01:23'26"	125	00:01'10"	158	00:26'46"	02:38'49"418	+00:40'16"158
159	304	aucun	Pirson Paul	69	M24	aucun	165	00:45'51"	116	00:01'10"	167	01:24'05"	175	00:01'28"	149	00:26'17"	02:38'53"864	+00:40'20"604
160	119	04533F95	Rubbrecht Sofie	1	F18	LT	136	00:43'19"	59	00:00'58"	164	01:23'38"	217	00:02'59"	177	00:28'04"	02:39'00"903	+00:40'27"643
161	63	57362M59	Haerden Yves	15	M50	BTC	162	00:45'40"	84	00:01'03"	162	01:23'32"	218	00:03'23"	136	00:25'23"	02:39'04"306	+00:40'31"046
162	135	59061M75	Jadot Olivier	70	M24	P8	180	00:46'48"	199	00:01'43"	173	01:24'33"	181	00:01'33"	123	00:24'47"	02:39'26"120	+00:40'52"860
163	147	59483M67	Fioretti Giorgio	40	M40	RCBT	198	00:49'21"	149	00:01'19"	149	01:21'48"	163	00:01'24"	139	00:25'37"	02:39'31"641	+00:40'58"381
164	200		Lamy Stéphane	41	M40	TNT	204	00:50'14"	214	00:02'09"	122	01:19'44"	194	00:01'43"	144	00:26'04"	02:39'57"157	+00:41'23"897
165	309		Ruban Sophie	8	F24	aucun	127	00:42'24"	19	00:00'48"	204	01:32'46"	22	00:00'48"	88	00:23'12"	02:40'00"393	+00:41'27"133
166	166		Colon Stéphane	71	M24	Sporthouse Team	182	00:47'01"	147	00:01'19"	143	01:21'25"	170	00:01'26"	185	00:29'00"	02:40'12"871	+00:41'39"611
167	215	58052F69	Bartz Laurence	3	F40	TRIGT	194	00:48'38"	111	00:01'09"	154	01:22'34"	95	00:01'01"	165	00:27'15"	02:40'40"239	+00:42'06"979
168	73	07668M84	Matthieu Toon	72	M24	DTTA	160	00:45'17"	58	00:00'58"	179	01:25'35"	164	00:01'24"	170	00:27'24"	02:40'41"263	+00:42'08"003
169	189	A12142C0160195MS3FRA	Laloy Brice	73	M24	TGV 54	185	00:47'41"	87	00:01'04"	163	01:23'37"	122	00:01'09"	174	00:27'42"	02:41'15"215	+00:42'41"955
170	173	59315M72	Deceuninck Georges	42	M40	TCDM	139	00:43'34"	105	00:01'08"	195	01:30'45"	123	00:01'10"	129	00:25'04"	02:41'42"323	+00:43'09"063
171	323	aucun	Wathelet Damien	74	M24	aucun	146	00:44'02"	166	00:01'24"	197	01:31'04"	166	00:01'25"	99	00:23'50"	02:41'47"491	+00:43'14"231
172	114	09023M77	Vandamme Bart	75	M24	KTT	163	00:45'50"	156	00:01'21"	177	01:24'49"	151	00:01'19"	184	00:28'49"	02:42'10"837	+00:43'37"577
173	41	56192M64	Ahn Stéphane	16	M50	BIN	187	00:47'49"	96	00:01'06"	144	01:21'27"	149	00:01'18"	198	00:31'11"	02:42'54"445	+00:44'21"185
174	70	59193M73	Servais Gérard	43	M40	CCSTC	170	00:46'09"	201	00:01'48"	180	01:26'37"	153	00:01'21"	163	00:27'02"	02:43'00"173	+00:44'26"913
175	58	58655m89	Baïolet Maxime	76	M24	CCSTC	142	00:43'38"	143	00:01'17"	145	01:21'30"	186	00:01'36"	210	00:35'18"	02:43'21"511	+00:44'48"251
176	106	57563M63	Moreaux Patrick	17	M50	HTT	211	00:52'41"	140	00:01'16"	98	01:17'00"	136	00:01'13"	201	00:31'41"	02:43'53"273	+00:45'20"013
177	42	58895F93	De Groote Estelle	3	FU23	BIN	183	00:47'02"	152	00:01'20"	190	01:29'08"	85	00:01'00"	137	00:25'24"	02:43'55"970	+00:45'22"710
178	271	aucun	Bovendaerde Daniel	2	M60	aucun	208	00:51'45"	205	00:01'51"	151	01:22'08"	202	00:01'51"	155	00:26'38"	02:44'15"047	+00:45'41"787
179	153	56662F64	Regenberg Verena	2	F50	RCBT	179	00:46'47"	180	00:01'29"	193	01:30'30"	140	00:01'14"	113	00:24'26"	02:44'28"062	+00:45'54"802
180	51	56668F88	Lambert Anne-sophie	9	F24	BTC	189	00:47'56"	85	00:01'03"	188	01:28'42"	116	00:01'08"	141	00:25'45"	02:44'36"787	+00:46'03"527
181	157	58951F70	Van De Moosdyk Cécile	4	F40	RCBT	181	00:46'52"	176	00:01'28"	194	01:30'38"	183	00:01'33"	118	00:24'31"	02:45'05"612	+00:46'32"352
182	293	aucun	Habran Olivier	44	M40	aucun	169	00:46'04"	184	00:01'31"	184	01:27'20"	167	00:01'25"	183	00:28'43"	02:45'06"161	+00:46'32"901
183	175	59319M74	Favart Cédric	45	M40	TCDM	131	00:42'47"	183	00:01'31"	175	01:24'37"	178	00:01'31"	213	00:35'42"	02:46'10"467	+00:47'37"207
184	59	56437M59	Bastien Jean-luc	18	M50	CCSTC	195	00:48'41"	178	00:01'29"	187	01:28'12"	199	00:01'47"	161	00:26'54"	02:47'05"117	+00:48'31"857
185	103	57977M65	Feuillet Johan	46	M40	HTT	199	00:49'30"	112	00:01'09"	176	01:24'42"	169	00:01'26"	196	00:30'19"	02:47'07"806	+00:48'34"546
186	81	57616M95	Honnay Nathan	3	M18	ENERGY	203	00:49'57"	122	00:01'13"	166	01:23'48"	127	00:01'11"	200	00:31'14"	02:47'25"195	+00:48'51"935
187	267	aucun	Abbiss Christian	77	M24	aucun	171	00:46'10"	198	00:01'43"	208	01:34'46"	161	00:01'23"	111	00:24'22"	02:48'26"732	+00:49'53"472
188	105	59598M78	Laval Bernard	78	M24	HTT	191	00:48'12"	153	00:01'20"	200	01:31'43"	177	00:01'30"	156	00:26'40"	02:49'28"144	+00:50'54"884
189	213	aucun	Oulukoff Namjal	19	M50	trifast team	172	00:46'12"	191	00:01'36"	206	01:33'28"	147	00:01'17"	169	00:27'20"	02:49'56"017	+00:51'22"757
190	56	59637M68	Wischermann Ralph	47	M40	BTC	176	00:46'42"	217	00:02'24"	198	01:31'21"	216	00:02'43"	167	00:27'19"	02:50'32"533	+00:51'59"273
191	133	56449M78	Daout Bertrand	79	M24	P8	177	00:46'43"	207	00:01'51"	203	01:32'37"	204	00:01'54"	176	00:27'59"	02:51'06"754	+00:52'33"494
192	149		Greffe Pierre	80	M24	RCBT	201	00:49'43"	97	00:01'07"	189	01:28'46"	93	00:01'01"	197	00:31'10"	02:51'48"956	+00:53'15"696

193	83	59413m83	Marien Francois	81	M24	ENERGY	209	00:52'18"	137	00:01'16"	169	01:24'20"	195	00:01'45"	205	00:32'45"	02:52'25"	908	+00:53'52"	648
194	295		Jadot Adélie	4	FU23	aucun	188	00:47'54"	174	00:01'28"	210	01:35'22"	165	00:01'25"	171	00:27'28"	02:53'37"	544	+00:55'04"	284
195	44	08668M69	Van Meel Peter	48	M40	BRTC	210	00:52'20"	209	00:01'59"	196	01:30'54"	209	00:02'08"	152	00:26'26"	02:53'48"	989	+00:55'15"	729
196	143	aucun	Renard Christophe	23	MU23	RCAE	178	00:46'44"	222	00:03'41"	205	01:32'53"	203	00:01'52"	190	00:29'41"	02:54'53"	689	+00:56'20"	429
197	36	58257F64	Vanesse Myriam	3	F50	ATCC	216	00:53'03"	170	00:01'24"	199	01:31'42"	105	00:01'05"	179	00:28'17"	02:55'33"	979	+00:57'00"	719
198	199	57710M89	Laduron Antoine	82	M24	TNT	219	00:53'50"	75	00:01'01"	192	01:29'33"	89	00:01'01"	206	00:33'12"	02:58'38"	846	+01:00'05"	586
199	283	aucun	Devogelaere Maxime	24	MU23	aucun	193	00:48'31"	204	00:01'50"	211	01:36'31"	188	00:01'39"	192	00:30'08"	02:58'41"	803	+01:00'08"	543
200	182		Palumbo Nancy	5	F40	TCDM	215	00:52'56"	190	00:01'36"	201	01:31'57"	211	00:02'13"	194	00:30'14"	02:58'58"	541	+01:00'25"	281
201	190		Ludwiczak Julia	10	F24	TGV 54	214	00:52'52"	144	00:01'17"	207	01:33'58"	158	00:01'23"	188	00:29'26"	02:58'58"	623	+01:00'25"	363
202	179	aucun	Maistriau Etienne	49	M40	TCDM	206	00:51'26"	187	00:01'34"	202	01:32'30"	198	00:01'47"	202	00:31'45"	02:59'05"	314	+01:00'32"	054
203	229	56870M91	Willame Thomas	25	MU23	TURBO	200	00:49'37"	133	00:01'15"	213	01:39'10"	97	00:01'02"	182	00:28'37"	02:59'44"	062	+01:01'10"	802
204	284	aucun	Dujardin Christophe	50	M40	aucun	212	00:52'43"	218	00:02'27"	191	01:29'18"	197	00:01'45"	211	00:35'22"	03:01'36"	445	+01:03'03"	185
205	127		Montois Louise	5	FU23	NSTT	186	00:47'44"	188	00:01'36"	220	01:43'29"	187	00:01'37"	168	00:27'19"	03:01'47"	061	+01:03'13"	801
206	274	aucun	Cornelis Eric	51	M40	aucun	213	00:52'46"	106	00:01'08"	212	01:37'20"	104	00:01'04"	195	00:30'16"	03:02'35"	872	+01:04'02"	612
207	313	aucun	Torreelle Yoëll	83	M24	aucun	197	00:49'09"	221	00:02'45"	217	01:41'39"	214	00:02'29"	189	00:29'34"	03:05'38"	638	+01:07'05"	378
208	239	A07916C 0190122MV3FRA	Bauduin Raphael	20	M50	wasquehal triathlon	221	00:54'31"	212	00:02'05"	209	01:35'21"	189	00:01'39"	207	00:34'07"	03:07'46"	239	+01:09'12"	979
209	237	020678859236MS2FRA	Dompierre Benoit	84	M24	VILLENEUVE D'ASCQ T	207	00:51'32"	139	00:01'16"	216	01:41'04"	107	00:01'05"	212	00:35'30"	03:10'29"	240	+01:11'55"	980
210	314	aucun	Vaesen Gilbert	3	M60	aucun	220	00:54'08"	206	00:01'51"	214	01:39'33"	215	00:02'39"	214	00:36'35"	03:14'48"	246	+01:16'14"	986
211	300		Magnee Dominique	1	F60	aucun	217	00:53'39"	173	00:01'27"	221	01:45'49"	200	00:01'49"	204	00:32'11"	03:14'57"	684	+01:16'24"	424
212	101	59580M52	Bultot Jean-marie	4	M60	HTT	205	00:50'37"	216	00:02'17"	222	01:51'59"	208	00:02'00"	178	00:28'06"	03:15'02"	099	+01:16'28"	839
213	270	aucun	Birenbaum Alain Alain	21	M50	aucun	218	00:53'49"	213	00:02'08"	215	01:40'48"	213	00:02'28"	215	00:37'51"	03:17'05"	419	+01:18'32"	159
214	174	aucun	Dupont Christophe	52	M40	TCDM	223	00:55'24"	219	00:02'39"	218	01:42'52"	212	00:02'19"	208	00:34'17"	03:17'33"	396	+01:19'00"	136
215	169	59675f90	Timmermann Aurélie	11	F24	TCDH	224	00:58'14"	196	00:01'39"	219	01:43'06"	179	00:01'32"	209	00:34'50"	03:19'22"	686	+01:20'49"	426
216	268	aucun	Aerts Bastien	26	MU23	aucun	222	00:54'40"	220	00:02'42"	223	01:53'31"	219	00:04'29"	216	00:58'25"	03:53'48"	409	+01:55'15"	149
DSQ	112	04990M92	Vanhoutte Witze		MU23	ITC														
DSQ	117	00616M78	Maggen Kevin		M24	LT														
DNF	218	59122M875855 TRIGT	Dewalque Nicolas		M24	Tri GT														
NC	9	05720F91	L'hoest Charlotte		FU23	NLT	228	02:48'06"	223	00:07'59"										
NC	65	59553M78	Lange Olivier		M24	CCSTC	54	00:38'02"	31	00:00'52"	136	01:20'47"	135	00:01'13"						
NC	98	07072M75	Perneel Joeri		M24	FTT	144	00:43'50"	115	00:01'10"	67	01:13'50"	220	01:21'13"						
NC	111	03535M89	Vande Capelle Ward		M24	ITC	14	00:35'17"	4	00:00'42"	82	01:14'52"	221	01:29'14"						
NC	128	57820f75	Platteeuw Véronique		F24	TRIGT	227	02:29'38"												
NC	139	57351M87	Geluykens Hans		M24	PMX	196	00:48'46"	226	02:31'19"										
NC	165	56697M89	Nihoul Robin		M24	SPEEDX	225	01:42'52"	225	01:37'13"										
NC	221	57727F94	Jonniaux Sigrid		FU23	TRIGT	226	02:11'35"	224	01:06'38"										
NC	232	05100F75	De Wulf Isabelle		F24	UTO	190	00:47'58"	109	00:01'08"	130	01:20'03"	83	00:00'59"						
NC	242	04461M91	Truyers Jonathan		MU23	ZT	85	00:39'58"	126	00:01'14"	1	00:28'23"	1	00:00'31"						
NC	318	aucun	Vandecappelle Patrick		M24	aucun	103	00:40'49"	189	00:01'36"	2	00:35'24"	222	02:02'15"						
NC	467	57290M86	Amato Raphael		M24	TRIGT	17	00:35'32"	68	00:01'00"	40	01:11'30"	28	00:00'49"						

DNF: Did Not Finish; DSQ: Disqualified

Résultats du Championnat FSUB
d'Ultimate Frisbee
Hogeschool Gent
Mercredi 25 juin 2014



BSK Ultimate Frisbee 25 juni 2014

POULE-VERDELING

	POULE A		POULE B
1A	ULB	1B	UCL
2A	Ass. KULeuven	2B	AUGent
3A	UGent	3B	AUHL
4A	-----	4B	HENALLUX

POULESTAND

	POULE A		POULE B
1 ^e	ULB	1 ^e	UCL
2 ^e	Ass. KUL	2 ^e	AUGent
3 ^e	UGent	3 ^e	HENALUX
4 ^e	-----	4 ^e	AUHL

HALVE FINALE

1 ^e A	ULB	2 ^e B	AUGent
2 ^e A	Ass.KUL	1 ^e B	UCL

TROOSTING

AUGent	Ass.KULeuven
--------	--------------

FINALE

ULB	UCL
-----	-----

VERLIEZERSPOULE

3 ^e A	UGent	3 ^e B	HENALUX
3 ^e B	HENALUX	4 ^e B	AUHL
3 ^e A	UGent	4 ^e B	AUHL

SPIRIT OF THE GAME AWARD

Ass. KULeuven

TIME	TEAMS	FIELD	SCORE
10u30-11u10 (40')	1B UCL -2B AUGent 3B AUHL -4B HENALLUX	1 2	10-3 5-7
11u15-12u00 (45')	1A ULB- 2A Ass. KULeuven	1	13-1
12u05-12u45 (40')	1B UCL -4B HENALLUX 2B AUGent -3B AUHL	1 2	13-1 7-4
12u50-13u35 (45')	1A ULB - 3A UGent	1	13-3
13u40-14u20 (40')	1B UCL -3B AUHL 2B AUGent-4B HENALLUX	1 2	13-1 12-1
14u25-15u10 (45')	2A Ass. KULeuven- 3A UGent	1	7-4
15u10	BREAK 15'		
	HALVE FINALES		
15u25-16u05 (40')	1 ^e poule A ULB-2 ^e poule B AUG 3 ^e poule A UG - 3 ^e poule B HENA	1 2	10-5 7-4
16u10-16u50 (40')	1 ^e poule B UC -2 ^e poule A Ass KUL 3 ^e poule B HENA- 4 ^e poule B AUHL	1 2	10-2 8-5
16u50	BREAK 15'		
17u05-17u44 (40')	3 ^e poule A UG - 4 ^e poule B AUHL	2	5-2
17u05-17u45 (40')	TROOSTING AUGent - Ass. KULeuven	1	11-7
17u50-18u30 (40')	FINALE ULB - UCL	1	5-4



EINDUITSLAG

1.	ULB
2.	UCL
3.	AUGent
4.	Ass.KULeuven
5.	UGent
6.	HENALUX
7.	AUHL

FINALES FSUB 2013-2014

Futsal hommes	ULB	Artevelde	1-3
Futsal dames	HEPL	VUB	6-8
Football	UCL	Ass. KULeuven	3-4
Handball hommes	HEPL	Ass. UGENT	25-25 (25-28 après prolongations)
Rugby	HEPL	Ass. KULeuven	43-10
Tennis dames	AUHLimburg	VUB	1-2
Volley-ball hommes	UGENT	Ulg (Lg)	3-0 (25-16 / 25-12 / 25-20)
Volley-ball dames	HEPL	KULeuven	2-3 (25/23- 16/25- 25/22- 19/25- 11/15)
Waterpolo	UCL	UAB	7-11