

B.U.S.F. - F.S.U.B.

































**RÉSULTATS SAISON SPORTIVE
2022-2023
UITSLAGEN**



Association Sportive de l'Enseignement
Universitaire et Supérieur ASBL

















Fédération Sportive Universitaire Belge (FSUB)

2022-2023	Disciplines	Dates	Lieux 2022-23	Organisateurs 2022-23	Participants Enseignement Supérieur 2019-20	Participants Enseignement Supérieur 2021-22	Participants Enseignement Supérieur 2022-23	Institutions représentées 2019-20	Institutions représentées 2021-22	Institutions représentées 2022-23
	Athlétisme indoor	Ve 24/02/23	Topsportthal Gent		586 (départs hors relais)	510	525 (départs hors relais)	37	34	35
	Athlétisme outdoor	Lu 01/05/23	Bloso centrum Putbosstadium		/	200 (départs hors relais)	362 (départs hors relais)	/	27	35
	Badminton	Me 01/03/23	Arteveldehogeschool campus Watersportbaan		42 + 23 équipes en double	38 + 16 équipes en double	82 + 20 équipes en double	16	9	13
	Course d'Orientation (Forêt)	Di 12/02/23	Thomas More - Lommel		26	31	31	9	6	7
	Course d'Orientation (Urbaine)	Sa 22/04/23	Hall Saint-Berthuin Malonne		/	/	15	/	/	4
	Cross-Country	Sa 12/11/21	Parc Allard - Braine L'Alleud (club USBW)		185	155	156	15	17	17
	Cyclisme Hommes	Ma 27/06/23	Zomergem		/	22	29 (1 francophone)	/	9	9
	Cyclisme Dames	Di 7/05/23	Sinaai		/	28 (1 francophone)	25 (2 francophones)	/	14	13
	Echecs	Me 15/02/23	Odisee Hogeschool (Campus Brussel)		33	59	63	10	18	14
	Escalade	Sa 25/03/23	Entre Ciel et Terre (Blocry LLN)		/	/	27	/	/	5
	Escrime	Sa 11/02/23	Club des 3 armes - Gembloux		/	79	57	/	21	19
	Floorball	Me 1/03/2023	UGent Sportcomplex (GUSB)- ANNULE		3 (8 joueurs/équipe)	3 (8 joueurs/équipes)	/	3	3	/
	Frisbee (Ultimate)	Di 23/04/23	Blocry à Louvain-la-Neuve- ANNULE		/	/	/	/	/	/
	Gymnastique	Lu 13/03/23	Blocry à Louvain-la-Neuve		/	41	58	/	7	10
	Judo individuel	Me 7/12/22	Université de Mons		78	78	71	19	21	19
	Judo par équipe	Me 8/03/23	Université de Mons		6 équipes (12 joueurs/équipe)	6 équipes (12 joueurs/équipes)	7	5	5	7



Fédération Sportive Universitaire Belge (FSUB)

2022-2023	Disciplines	Dates	Lieux 2022-23	Organisateurs 2022-23	Participants Enseignement Supérieur 2019-20	Participants Enseignement Supérieur 2021-22	Participants Enseignement Supérieur 2022-23	Institutions représentées 2019-20	Institutions représentées 2021-22	Institutions représentées 2021-22
	Natation	Ma 14/03/23	Piscine de Groenenhoek (Antwerpen)		199 (départs hors relais)	108 (départs hors relais)	198 (départs hors relais)	19	16	13
	Padel	Ve 21/04/23	Padel 4u2 Gentbrugge		/	5 équipes (double)	8 équipes (double)	/	5	3
	Rugby VII- Chpt	Je 9/03/23	Kituro Rugby Club - Schaerbeek- ANNULE		/	4 équipes hommes 3 équipes dames	/	/	4 (hommes) 4 (dames)	/
	Rugby VII- Tournoi	Je 20/10/23	Kituro Rugby Club - Schaerbeek- ANNULE		8 équipes hommes 3 équipes dames	6 équipes hommes 3 équipes dames	/	9 (hommes) 3 (dames)	6 (hommes) 3 (dames)	/
	Ski Slalom	Je 04/05/23	Skipiste Aspen - Antwerpen - ANNULE		/	/	/	/	/	/
	Tennis de Table	Lu 20/02/2023	Sport Centrum KU Leuven		41	34	70	13	12	15
	1/4 Triathlon	Di 28/05/23	Seneffe (club des Titans)		/	17	30	/	11	11
TOTAL					1271	1698	1308			

Résultats du Championnat FSUB d'Athlétisme outdoor

Oordegem

Lundi 1 mai 2023



Résultats du Championnat d'Athlétisme outdoor FSUB

Lundi 1 mai 2023

Participants par sexe, 609 au total

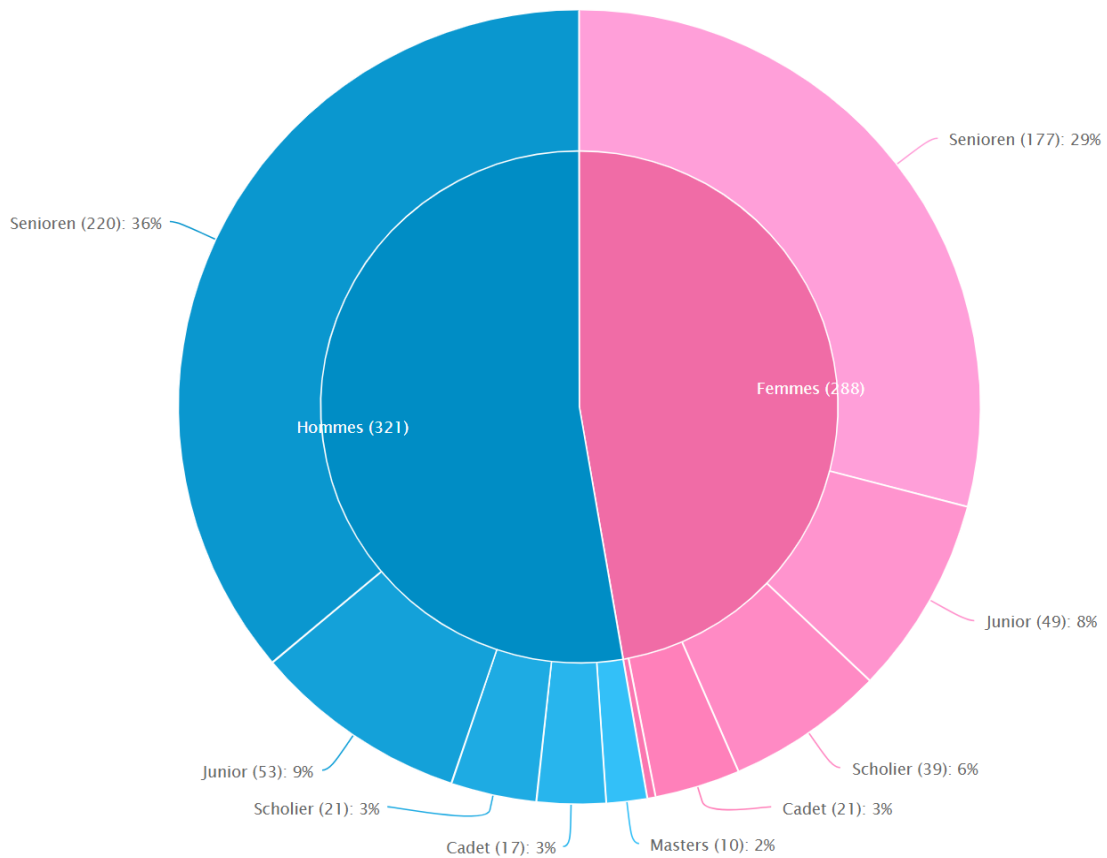

Participants par club, 609 au total

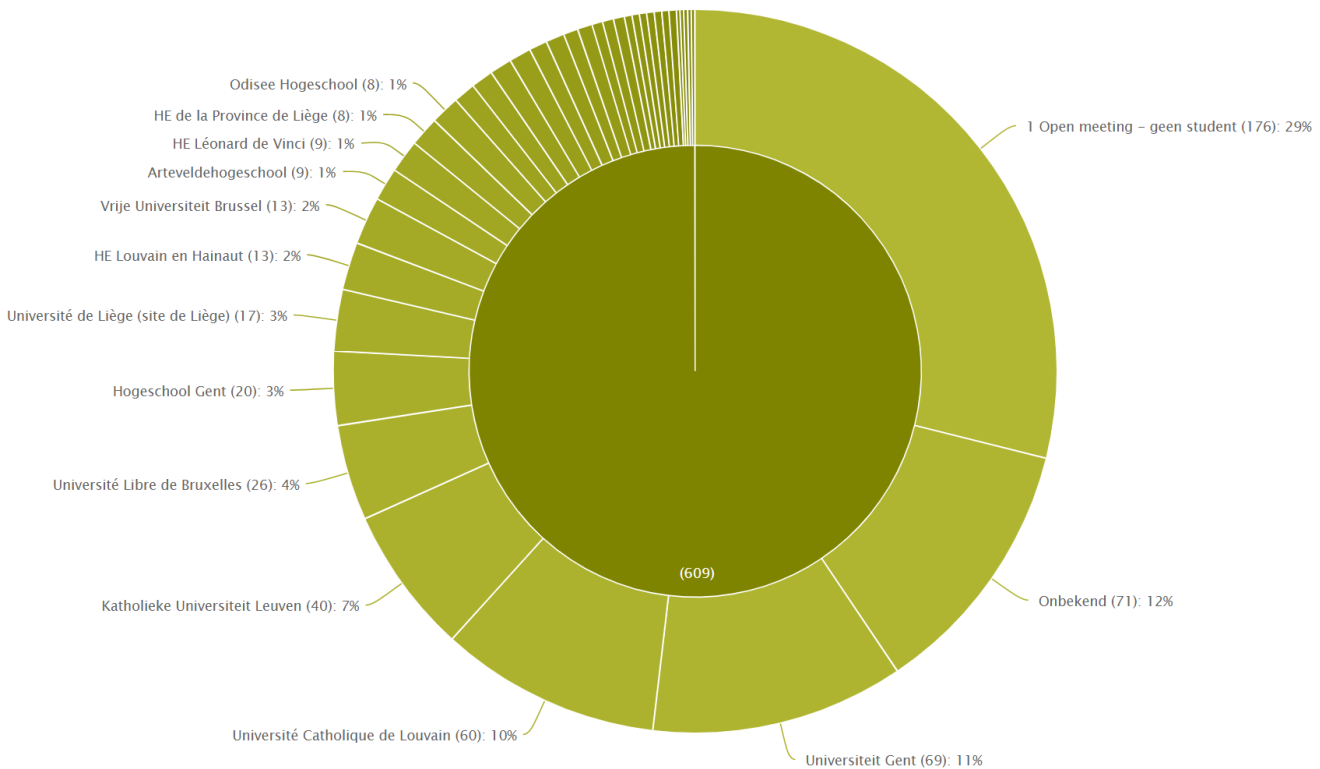

Hommes- 110m Haies

#	Nom	Club	Catégorie	Hauteur des ha...	Résultat		OBP
1	Nolan Vancauwemberghe	Université Catholique de Louvain	Seniors Hommes	106.7cm	14,02	-0.5 m/s	13,83
2	Jente Hautekeete	Arteveldehogeschool	Seniors Hommes	106.7cm	14,46	-0.5 m/s	14,50
3	Jannes Boonen	Inconnue	Seniors Hommes	106.7cm	14,70	-0.5 m/s	14,84
4	Robin Goossens	1 Open meeting - geen student	Seniors Hommes	106.7cm	14,83	-0.5 m/s	14,81
5	Senne Segers	Thomas More	Seniors Hommes	106.7cm	14,85	-0.5 m/s	14,26
6	Ewout Dumon	Inconnue	Seniors Hommes	106.7cm	14,99	-0.5 m/s	14,48
7	Maxime Debacker	HE Louvain en Hainaut	Seniors Hommes	106.7cm	15,33	-0.9 m/s	15,46
8	Wout Van Hoof	Universiteit Gent	Juniors Hommes	106.7cm	15,76	-0.9 m/s	16,22
9	Arnout Schokkaert	Universiteit Gent	Seniors Hommes	106.7cm	16,39	-0.9 m/s	16,42
10	Tom Vanmarsenille	Hogeschool Gent	Seniors Hommes	106.7cm	16,66	-0.9 m/s	17,10
11	Niels Laevens	Inconnue	Seniors Hommes	106.7cm	16,93	-0.9 m/s	16,45
12	Eduard Goffart Winkin	Katholieke Universiteit Leuven	Seniors Hommes	106.7cm	21,54	-0.9 m/s	---
	Hadrien Riga	HE de la Province de Liège	Seniors Hommes	106.7cm	DNF		15,28

Dames- 100m Haies

#	Nom	Club	Catégorie	Hauteur des ha...	Résultat		OBP
1	Angel Agwazie	Odisee Hogeschool	Seniors Femmes	83.8cm	13,66	-0.5 m/s	13,63
2	Lynn Beck	Katholieke Universiteit Leuven	Seniors Femmes	83.8cm	13,87	-0.5 m/s	13,70
3	Noor Koekelkoren	1 Open meeting - geen student	Juniors Femmes	83.8cm	14,25	-0.5 m/s	14,62
4	Zita Goossens	Universiteit Gent	Seniors Femmes	83.8cm	14,42	-0.5 m/s	14,41
5	Laures Bauwens	Universiteit Gent	Seniors Femmes	83.8cm	14,44	-0.9 m/s	---
6	Sara Roggeman	Universiteit Gent	Juniors Femmes	83.8cm	14,46	-0.5 m/s	14,40
7	Laura Van den Brande	Inconnue	Seniors Femmes	83.8cm	14,47	-0.5 m/s	14,32
8	Nina Denolf	Universiteit Gent	Seniors Femmes	83.8cm	14,83	-0.5 m/s	14,48
9	Emeline Cleymans	Université Catholique de Louvain	Seniors Femmes	83.8cm	15,18	-0.8 m/s	15,20
10	Lotte Philips	Katholieke Universiteit Leuven	Seniors Femmes	83.8cm	15,24	-0.8 m/s	14,98
11	Gretel Canters	Hogeschool PXL	Seniors Femmes	83.8cm	15,34	-0.8 m/s	15,29
12	Lolke Vierendeels	Universiteit Gent	Seniors Femmes	83.8cm	15,61	-0.8 m/s	16,40
13	Steffi De Saegher	Inconnue	Juniors Femmes	83.8cm	15,77	-0.9 m/s	19,59
14	Asgerdur Jana Agustsdottir	1 Open meeting - geen student	Seniors Femmes	83.8cm	15,86	-0.9 m/s	---
15	Caroline Bloch	HE de la Province de Liège	Seniors Femmes	83.8cm	16,31	-0.8 m/s	15,80
16	Antje De Schryver	1 Open meeting - geen student	Juniors Femmes	83.8cm	17,27	-0.9 m/s	---
17	Violette Ackaert	Université de Liège (site de Liège)	Seniors Femmes	83.8cm	18,76	-0.9 m/s	16,42
	Aurore Duchêne	Université Libre de Bruxelles	Seniors Femmes	83.8cm	DNF		---

Hommes- 3000m steeple

#	Nom	Club	Catégorie	Hauteur des ha...	Résultat		OBP
1	Lucas Lievens	Arteveldehogeschool	Seniors Hommes	91.4cm	9:39,68		9:17,72
2	Maxime Coiffé	Université Libre de Bruxelles	Seniors Hommes	91.4cm	10:27,55		---
3	Jonas Wuyts	Universiteit Antwerpen	Seniors Hommes	91.4cm	11:01,47		---
4	Tim Vandevelde	Hogeschool West-Vlaanderen	Seniors Hommes	91.4cm	11:15,24		11:01,00

Dames- 3000m steeple

#	Nom	Club	Catégorie	Hauteur des ha...	Résultat		OBP
1	Jana Spiessens	Artis Plantijn Hogeschool Antwerpen	Seniors Femmes	76.2cm	13:19,89		12:49,77
2	Tina De Leye	1 Open meeting - geen student	Seniors Femmes	76.2cm	13:27,30		---





Hommes – 5000m

#	Nom	Club	Catégorie	Résultat		OBP
1	Sébastien Fauconnier	Université Catholique de Louvain	Seniors Hommes	14:24,58		14:48,04
2	Thomas Monfils	Inconnue	Seniors Hommes	14:49,61		---
3	Thomas Van der Kaa	Université Catholique de Louvain	Seniors Hommes	15:07,79		---
4	Donald Lalmand	HE Libre de Bruxelles	Seniors Hommes	15:41,79		---
5	Artem Onyshchenko	1 Open meeting - geen student	Juniors Hommes	15:47,55		15:26,99
6	Pierre Houssiere	Université Catholique de Louvain	Seniors Hommes	15:51,30		16:27,21
7	Ghislain Deswaef	HE Léonard de Vinci	Seniors Hommes	16:04,44		16:36,67
8	Benjamin De Greef	HE Léonard de Vinci	Seniors Hommes	16:27,28		---
9	Antoine Lechat	Université Catholique de Louvain	Seniors Hommes	16:33,45		---
10	Guillaume Robert	Inconnue	Seniors Hommes	16:49,33		---
11	Ruben Vercouter	Inconnue	Seniors Hommes	17:12,58		17:21,88
12	Simon Dendas	HE de Namur Liège Luxembourg	Seniors Hommes	17:33,76		---
13	Marlen Azhigallyev	Université Catholique de Louvain	Seniors Hommes	18:42,32		---
	DORIAN TORDEUR	Université Catholique de Louvain	Seniors Hommes	DNF		---
	Pierre Vancolen	Université Catholique de Louvain	Seniors Hommes	DNF		15:21,31













Dames- 5000m

#	Nom	Club	Catégorie	Résultat	OBP
1	 Valerie Rooms	1 Open meeting - geen student	Seniors Femmes	17:43,60	---
2	 Elisa Vancoelen	Université Catholique de Louvain	Seniors Femmes	17:46,61	18:11,14
3	 Bridey Waerzeggers	Vrije Universiteit Brussel	Seniors Femmes	19:16,27	18:25,68
4	 Lynn Hübinger	Université Catholique de Louvain	Juniors Femmes	19:56,00	---
5	 Bianca Hermans	Thomas More	Seniors Femmes	20:35,99	---
6	 Anneleen Vancoppenolle	Katholieke Universiteit Leuven	Seniors Femmes	21:52,17	---
7	 Elise Lechat	Université de Liège (site de Liège)	Seniors Femmes	21:54,57	---

Hommes- 1500m

#	Nom	Club	Catégorie	Résultat	OBP
1	 Andy Keymolen	Vrije Universiteit Brussel	Seniors Hommes	4:00,42	3:57,72
2	 Thibault Lelièvre	Université Catholique de Louvain	Seniors Hommes	4:01,37	4:02,62
3	 Amir Sidali	Erasmus Hogeschool Brussel	Seniors Hommes	4:02,43	4:09,59
4	 Nicolas Bourez	Université Catholique de Louvain	Seniors Hommes	4:05,46	4:11,00
5	 Achille Lelion	Inconnue	Juniors Hommes	4:05,81	4:11,08
6	 Antoine Berti	Inconnue	Seniors Hommes	4:06,00	4:03,00
7	 Louis Duyckaerts	Vrije Universiteit Brussel	Seniors Hommes	4:07,13	4:03,06
8	 Loïc Delvaux	HE Charlemagne	Seniors Hommes	4:07,70	4:06,63
9	 Renu De Samblancx	1 Open meeting - geen student	Cadets Hommes	4:08,02	4:17,36
10	 Dylan Champenois	Inconnue	Seniors Hommes	4:10,68	4:06,50
11	 Ruben Redant	Arteveldehogeschool	Seniors Hommes	4:11,22	4:12,30
12	 Antoine Lengele	Université de Mons	Seniors Hommes	4:11,36	4:08,21
13	 Kilani Njema	Inconnue	Cadets Hommes	4:14,28	4:07,49
14	 Tristan Blommaert	Thomas More	Seniors Hommes	4:21,40	4:15,45
15	 Henri Smeers	Université Catholique de Louvain	Juniors Hommes	4:22,65	4:24,75
16	 Pieter Van Hoecke	Universiteit Gent	Seniors Hommes	4:23,03	4:24,88
17	 Ilyas Sakouane Zaghdoud	1 Open meeting - geen student	Scolaires Hommes	4:24,27	4:35,83
18	 Matthias Meert	1 Open meeting - geen student	Cadets Hommes	4:28,83	4:38,65
19	 Michiel Van Durpe	Odisee Hogeschool	Seniors Hommes	4:29,44	4:28,95
20	 Liam Heirman	1 Open meeting - geen student	Scolaires Hommes	4:38,00	4:55,37
21	 François Clinquart	Université Catholique de Louvain	Juniors Hommes	4:39,69	---
22	 Mateo Longo-Murit	1 Open meeting - geen student	Cadets Hommes	4:42,36	---
23	 Kobe Dhont	Inconnue	Seniors Hommes	4:44,67	4:53,45
24	 Léo Renaldi	1 Open meeting - geen student	Cadets Hommes	4:51,23	---
25	 Odinn Van Damme	1 Open meeting - geen student	Cadets Hommes	5:07,81	4:53,78

Dames- 1500m

#	Nom	Club	Catégorie	Résultat	OBP
1	 Emma Dubie	HE Louvain en Hainaut	Seniors Femmes	4:49,80	4:37,66
2	 Eloïse LEFEVRE	Université de Liège (site de Liège)	Juniors Femmes	4:51,01	4:53,60
3	 Soraya Meert	Inconnue	Seniors Femmes	4:54,01	4:37,07
4	 Maximilienne Lombard	Université Libre de Bruxelles	Seniors Femmes	4:54,49	4:55,61
5	 Marie Mazzoli	Université Catholique de Louvain	Seniors Femmes	5:03,56	4:51,39
6	 Ambre Cogez	1 Open meeting - geen student	Scolaires Femmes	5:13,43	5:15,00
7	 Iseult Salliez	1 Open meeting - geen student	Scolaires Femmes	5:18,04	5:17,82
8	 Nina Richir Deville	1 Open meeting - geen student	Cadets Femmes	5:20,29	5:22,98
9	 Ayco Van Raemdonck	1 Open meeting - geen student	Scolaires Femmes	5:22,45	5:21,43
10	 Ine Laridon	Inconnue	Seniors Femmes	5:25,64	---
11	 Joke Steurbaut	Universiteit Gent	Seniors Femmes	5:31,03	5:29,24
12	 Lisa Marchant	Université Libre de Bruxelles	Seniors Femmes	5:31,87	---
13	 Zehra Berlangier	1 Open meeting - geen student	Scolaires Femmes	5:37,77	5:39,68

Hommes- 100m

#	Nom	Club	Catégorie	Résultat		OBP
1	Adrien Devriendt	Inconnue	Seniors Hommes	10,76	+1.7 m/s	10,80
2	Antoine Snyders	HE Libre Mosane	Seniors Hommes	10,76	+1.7 m/s	10,54
3	Cédric Motieh	1 Open meeting - geen student	Juniors Hommes	10,89	+1.7 m/s	10,73
4	Geoffrey Jacques	HE Libre Mosane	Seniors Hommes	10,89	+1.7 m/s	10,84
5	Ibrahim Camara	1 Open meeting - geen student	Juniors Hommes	10,90	+1.7 m/s	10,83
6	Marnix De Pauw	Odisee Hogeschool	Juniors Hommes	10,95	+1.7 m/s	10,80
7	Camille Snyders	HE de la Province de Liège	Seniors Hommes	11,03	-1.1 m/s	10,92
8	Clément Brunin	1 Open meeting - geen student	Seniors Hommes	11,05	+1.7 m/s	10,81
9	Nolan Vancauwemberghe	Université Catholique de Louvain	Seniors Hommes	11,06	-1.1 m/s	11,00
10	Thomas Van Ingelgem	1 Open meeting - geen student	Masters Hommes	11,10	-0.1 m/s	11,10
11	Floran Dehout	HE Louvain en Hainaut	Seniors Hommes	11,11	-0.1 m/s	11,16
12	Florian Tshitwenu	Ecole Pratiques des Hautes études Commerciales	Seniors Hommes	11,13	+1.7 m/s	10,66
13	Guélord Kola biasu	1 Open meeting - geen student	Seniors Hommes	11,13	-1.1 m/s	10,97
14	Meindert Caudron	Inconnue	Juniors Hommes	11,17	-0.1 m/s	11,08
15	Xavier Rousseau	1 Open meeting - geen student	Scolaires Hommes	11,17	-0.1 m/s	11,05
16	Bjirsen Deherder	1 Open meeting - geen student	Seniors Hommes	11,19	-0.1 m/s	11,27
17	Hadrien Wimlot	Université Libre de Bruxelles	Seniors Hommes	11,19	-0.1 m/s	11,11
18	Enguerran Bossicard	HE Louvain en Hainaut	Seniors Hommes	11,20	-1.1 m/s	10,87
19	Gautier Bricet	HE Léonard de Vinci	Seniors Hommes	11,22	-0.1 m/s	11,23
20	Jitse Mievis	Erasmus Hogeschool Brussel	Seniors Hommes	11,22	-1.1 m/s	10,85
21	Simon Dekoninck	Katholieke Universiteit Leuven	Juniors Hommes	11,24	-0.1 m/s	11,25
22	Stijn Van der Vreken	Hogeschool Gent	Juniors Hommes	11,26	-1.1 m/s	10,89
23	Siemen Masure	Universiteit Gent	Seniors Hommes	11,27	-1.1 m/s	10,94
24	Charles Hamaide	1 Open meeting - geen student	Seniors Hommes	11,28	-0.1 m/s	11,19
25	Tibe Temmerman	Inconnue	Juniors Hommes	11,28	-0.1 m/s	11,03
26	Maxime Debacker	HE Louvain en Hainaut	Seniors Hommes	11,32	-0.1 m/s	11,12
27	Quentin Hoffken	1 Open meeting - geen student	Juniors Hommes	11,33	-0.7 m/s	11,39
28	Marko Medan	Université Libre de Bruxelles	Seniors Hommes	11,34	-1.1 m/s	10,95
29	Nicolas Léonard	HE Léonard de Vinci	Seniors Hommes	11,39	-0.1 m/s	11,16
30	Dorian André	1 Open meeting - geen student	Seniors Hommes	11,40	-0.2 m/s	11,62
31	Yannil Sampson	Université de Liège (site de Liège)	Juniors Hommes	11,41	-0.7 m/s	11,42
32	Jean-Charles Nsangolo	1 Open meeting - geen student	Seniors Hommes	11,43	-0.7 m/s	11,35
33	Reginald Beele	Inconnue	Seniors Hommes	11,44	-0.1 m/s	11,26
34	Senne Segers	Thomas More	Seniors Hommes	11,49	-0.1 m/s	11,15
34	Gertjan Demeur	1 Open meeting - geen student	Seniors Hommes	11,49	-0.7 m/s	11,40
36	Simon Cotton	HE Louvain en Hainaut	Seniors Hommes	11,49	-0.1 m/s	11,12
37	Mateo Loforte	HE Libre Mosane	Seniors Hommes	11,58	-0.7 m/s	11,44
38	Jasper Vermaelen	1 Open meeting - geen student	Juniors Hommes	11,61	-0.2 m/s	11,56
39	Alexander Van Vliet	Universiteit Gent	Juniors Hommes	11,62	+1.1 m/s	11,90
40	Storm Tuyls	Hogeschool Gent	Seniors Hommes	11,64	-0.1 m/s	11,25
41	Cedric Oum Oyono	HE en Hainaut	Seniors Hommes	11,69	-0.7 m/s	---
42	Titouan Danno	Université Libre de Bruxelles	Seniors Hommes	11,70	+1.1 m/s	11,86
43	Jarne Mariën	Universiteit Antwerpen	Juniors Hommes	11,71	-0.2 m/s	11,67
44	Jason Schollaert	Katholieke Universiteit Leuven	Seniors Hommes	11,72	+1.1 m/s	12,02
45	Melvyn Claes	Université Catholique de Louvain	Seniors Hommes	11,75	-0.2 m/s	11,74
46	Briek Ryckaert	1 Open meeting - geen student	Juniors Hommes	11,75	-0.2 m/s	11,75
47	Ludovic Fenaux	1 Open meeting - geen student	Masters Hommes	11,79	-0.7 m/s	11,33
48	Zaaquib Yunus Ahmed	1 Open meeting - geen student	Seniors Hommes	11,83	-0.7 m/s	11,51
49	Robbe Van Hoorde	1 Open meeting - geen student	Scolaires Hommes	11,85	-0.7 m/s	---
50	Noé Koch	Université Catholique de Louvain	Seniors Hommes	11,90	-0.2 m/s	11,77
51	Mathys Van Hove	1 Open meeting - geen student	Juniors Hommes	11,93	-0.7 m/s	11,39
52	Victor De Spiegeleire	1 Open meeting - geen student	Scolaires Hommes	11,96	-0.3 m/s	12,27
53	Melchizedek Agyemang	Hogeschool Gent	Seniors Hommes	11,98	-0.2 m/s	11,76





53	Victor Suy	Universiteit Gent	Juniors Hommes	11,98	+1.1 m/s	11,90
55	Gaëtan Van Buynder	Hogeschool Gent	Juniors Hommes	12,02	-0.3 m/s	---
56	Stef Wageman	1 Open meeting - geen student	Scolaires Hommes	12,03	-0.3 m/s	12,21
57	Ethan Sébastien Dumont	HE Provinciale du Hainaut-Condorcet	Seniors Hommes	12,11	-0.3 m/s	12,87
58	Wouter Vander Mijnsbrugge	1 Open meeting - geen student	Seniors Hommes	12,14	+1.1 m/s	12,10
59	Amaury Meskens	Université Libre de Bruxelles	Seniors Hommes	12,18	-0.7 m/s	---
60	Tristan Bistrussu	1 Open meeting - geen student	Juniors Hommes	12,19	-0.3 m/s	12,84
61	Ali Lachkar	Université Libre de Bruxelles	Seniors Hommes	12,25	-0.2 m/s	11,73
62	Michiel Hagen	Katholieke Universiteit Leuven	Seniors Hommes	12,34	-0.3 m/s	12,16
63	Elouan LANIER	HE Libre de Bruxelles	Seniors Hommes	12,34	-0.3 m/s	---
64	Joachim Laus	1 Open meeting - geen student	Masters Hommes	12,37	-0.3 m/s	12,21
65	Jakob Verleyen	1 Open meeting - geen student	Cadets Hommes	12,39	0.3 m/s	12,64
66	Matisse Barbio	1 Open meeting - geen student	Juniors Hommes	12,40	+1.1 m/s	12,15
67	Joppe Gutschoven	1 Open meeting - geen student	Scolaires Hommes	12,67	-0.3 m/s	12,91
68	Jesse Claus	1 Open meeting - geen student	Cadets Hommes	12,71	-0.3 m/s	13,29
69	Lucas Batlle	Université de Liège (site de Liège)	Seniors Hommes	12,91	-0.7 m/s	---
70	Pascal Rijdant	1 Open meeting - geen student	Masters Hommes	13,01	-0.3 m/s	12,73
71	MAXIME Piedboeuf	HE de la Province de Liège	Juniors Hommes	13,24	-0.7 m/s	---
72	Aurélien Belle	HE Louvain en Hainaut	Seniors Hommes	13,66	-0.3 m/s	---
73	Michaël De Prins	Karel de Grote Hogeschool	Seniors Hommes	13,75	-0.3 m/s	13,47
74	Tim De Reuse	1 Open meeting - geen student	Masters Hommes	14,15	-0.7 m/s	---
75	Siméon Collart	Inconnue	Cadets Hommes	14,46	-0.7 m/s	---
	Liam Sprangers	Universiteit Gent	Seniors Hommes	DNS		11,93

Dames- 100m





























#	Nom	Club	Catégorie	Résultat		OBP
1	Rani Vincke	Universiteit Gent	Seniors Femmes	11,72	-0.1 m/s	11,53
2	Lotte Van Lent	Katholieke Universiteit Leuven	Seniors Femmes	11,83	-0.1 m/s	11,79
3	Callie Lizzie Nzukou Wakam	Université Libre de Bruxelles	Seniors Femmes	11,84	-0.2 m/s	12,09
4	Janie De Naeyer	Universiteit Antwerpen	Seniors Femmes	11,86	-0.1 m/s	11,71
5	Nora Thiry	HE de la Province de Liège	Seniors Femmes	11,99	-0.1 m/s	11,71
6	Angel Agwazie	Odisee Hogeschool	Seniors Femmes	12,15	-0.2 m/s	12,05
7	Anouchka Kadiamba	Hogeschool Gent	Seniors Femmes	12,20	-0.2 m/s	12,02
8	Cloe CHAVEPEYER	HE Louvain en Hainaut	Seniors Femmes	12,20	-0.1 m/s	11,72
9	Camille Sonnevile	1 Open meeting - geen student	Scolaires Femmes	12,21	-0.2 m/s	12,16
10	Tinne Vertongen	1 Open meeting - geen student	Juniors Femmes	12,24	-0.1 m/s	11,89
11	Alizee Morency Poilvache	Université Libre de Bruxelles	Seniors Femmes	12,25	-0.1 m/s	11,71
12	Lynn Beck	Katholieke Universiteit Leuven	Seniors Femmes	12,26	-0.2 m/s	12,26
13	Evy Seghers	Vrije Universiteit Brussel	Seniors Femmes	12,28	-0.2 m/s	12,23
14	Sarah-Daisy Tshiamala-Bitota	HE Louvain en Hainaut	Seniors Femmes	12,34	-0.1 m/s	11,91
15	Noor Vermeiren	1 Open meeting - geen student	Juniors Femmes	12,45	-2.1 m/s	12,32
16	Libelia Vincke	Hogeschool West-Vlaanderen	Seniors Femmes	12,55	-0.2 m/s	12,01
17	Aurore Duchêne	Université Libre de Bruxelles	Seniors Femmes	12,56	-2.1 m/s	12,54
18	Zoë Willemyns	1 Open meeting - geen student	Scolaires Femmes	12,66	-0.6 m/s	12,64
19	Kyra Janssens	Vrije Universiteit Brussel	Seniors Femmes	12,66	-0.2 m/s	12,28
20	Sterre Provost	1 Open meeting - geen student	Scolaires Femmes	12,70	-2.1 m/s	12,32
21	Nona Heyvaert	1 Open meeting - geen student	Juniors Femmes	12,72	-0.6 m/s	12,65
22	Chloe Philippe	1 Open meeting - geen student	Scolaires Femmes	12,74	-2.1 m/s	12,47
23	Dora De Haseleer	Université Catholique de Louvain	Seniors Femmes	12,80	-2.1 m/s	12,45
24	Elise Léonard	Inconnue	Juniors Femmes	12,82	-2.1 m/s	12,61
25	Jutta Decock	Katholieke Universiteit Leuven	Seniors Femmes	12,88	-1.3 m/s	12,89
26	Chloé Violle	Université de Liège (site de Liège)	Seniors Femmes	12,88	-0.6 m/s	12,78

27	 Sara Roggeman	Universiteit Gent	Juniors Femmes	12,92	-1.3 m/s	12,97
28	 Chloe O'Shea	Université Catholique de Louvain	Seniors Femmes	12,93	-0.6 m/s	 12,81
29	 Lisa De Troyer	Hogeschool Gent	Juniors Femmes	12,94	-0.1 m/s	13,06
30	 Ellen Anckaert	1 Open meeting - geen student	Scolaires Femmes	 13,00	-0.1 m/s	13,08
31	 Lotte Van der Vreken	Universiteit Gent	Seniors Femmes	 13,00	-0.6 m/s	12,81
32	 Emeline Lippens	1 Open meeting - geen student	Scolaires Femmes	13,01	-0.6 m/s	13,21
33	 Nande De Kimpe	1 Open meeting - geen student	Scolaires Femmes	 13,03	-0.6 m/s	12,80
34	 Charlotte Kinable	Katholieke Universiteit Leuven	Seniors Femmes	 13,03	-2.1 m/s	12,46
35	 Emma Hiel	Arteveldehogeschool	Seniors Femmes	13,04	-1.3 m/s	12,93
36	 Valentine Anyanwu	Université Catholique de Louvain	Juniors Femmes	13,07	-0.6 m/s	12,78
37	 Bente Van Ingelgem	1 Open meeting - geen student	Cadets Femmes	13,09	-0.2 m/s	13,67
38	 Eléa Godeau	1 Open meeting - geen student	Juniors Femmes	13,10	-1.3 m/s	12,94
39	 Lore Van den Bremt	Arteveldehogeschool	Seniors Femmes	13,11	-0.1 m/s	12,97
40	 Yana Goosen	1 Open meeting - geen student	Juniors Femmes	13,12	-1.3 m/s	 12,90
41	 Iris Lefevere	1 Open meeting - geen student	Scolaires Femmes	 13,23	+0.4 m/s	13,82
42	 Estelle Jennes	Université de Liège (site de Liège)	Juniors Femmes	 13,23	-0.1 m/s	13,14
43	 Anna De Gryze	Inconnue	Scolaires Femmes	 13,25	-1.3 m/s	12,88
44	 Laureen Cugnet-Evans	Université Catholique de Louvain	Seniors Femmes	 13,25	-0.1 m/s	12,99
45	 Emma Frans	HE Libre Mosane	Seniors Femmes	13,26	-0.6 m/s	13,18
46	 Yelena Boone	1 Open meeting - geen student	Juniors Femmes	 13,27	-1.3 m/s	12,91
47	 Zina Looverie	1 Open meeting - geen student	Scolaires Femmes	 13,27	-0.6 m/s	13,29
48	 Steffi De Saegher	Inconnue	Juniors Femmes	13,28	-2.1 m/s	12,61
49	 Anaëlle Rousseau	1 Open meeting - geen student	Scolaires Femmes	13,31	-0.6 m/s	 13,30
50	 Lisa Van Renterghem	Hogeschool Gent	Seniors Femmes	13,43	-0.2 m/s	13,43
51	 Monica Peñalver Garcia	HE Léonard de Vinci	Seniors Femmes	 13,45	-0.1 m/s	13,12
52	 Julia Alegre	Université de Liège (site de Liège)	Seniors Femmes	 13,45	+0.4 m/s	13,69
53	 Riet Van Aerschot	Inconnue	Juniors Femmes	13,47	-0.6 m/s	13,23
54	 Miek Lagaeyse	Universiteit Gent	Juniors Femmes	13,49	+0.4 m/s	13,84
55	 Anne-Ramon Cole	Vrije Universiteit Brussel	Juniors Femmes	 13,55	-0.2 m/s	13,40
56	 Saartje Lansen	1 Open meeting - geen student	Scolaires Femmes	 13,55	-1.3 m/s	12,90
57	 Maimouna Cisse	Inconnue	Scolaires Femmes	13,59	-0.1 m/s	13,14
58	 Jeanne Swaelens	Inconnue	Juniors Femmes	13,63	-0.2 m/s	13,34
59	 France Vande Cavey	Inconnue	Juniors Femmes	13,65	-0.1 m/s	13,17
60	 Clara Ruzziconi	HE Libre Mosane	Seniors Femmes	13,73	-0.6 m/s	13,32
61	 Myrthe Gobert	Universiteit Antwerpen	Seniors Femmes	13,80	-0.2 m/s	13,57
62	 Camille Chauvin	HE Provinciale du Hainaut-Condorcet	Seniors Femmes	 13,82	+0.4 m/s	13,91
63	 Elise Romeyns	Inconnue	Scolaires Femmes	 13,82	+0.4 m/s	13,91
64	 Kaat Smet	1 Open meeting - geen student	Cadets Femmes	13,87	-0.4 m/s	14,46
65	 Maëva Defosse	Université de Mons	Seniors Femmes	13,90	-0.2 m/s	13,36
66	 Caitlin Verleysen	Karel de Grote Hogeschool	Juniors Femmes	13,93	-0.6 m/s	13,31
67	 Orligane Manteau	HE Provinciale du Hainaut-Condorcet	Seniors Femmes	 13,95	+0.4 m/s	14,07
68	 Paoline Debisschop	Université Catholique de Louvain	Seniors Femmes	 13,95	-0.6 m/s	13,33
69	 Rosanne Verbruggen	Katholieke Universiteit Leuven	Seniors Femmes	14,06	-0.4 m/s	14,10
70	 Jasmine Fonck	1 Open meeting - geen student	Scolaires Femmes	14,09	-0.5 m/s	---
71	 Lien Rubbrecht	Universiteit Gent	Seniors Femmes	14,14	-0.2 m/s	13,61
72	 Lucca Delos	1 Open meeting - geen student	Scolaires Femmes	 14,32	-0.4 m/s	14,37
73	 Mogan Heirman	1 Open meeting - geen student	Cadets Femmes	 14,32	-0.4 m/s	14,43
74	 Claire LE POULARD	Université de Liège (site de Liège)	Seniors Femmes	 14,32	-0.5 m/s	---
75	 Norah De Jaeger	Inconnue	Cadets Femmes	14,35	-0.4 m/s	14,39
76	 Lore REMBAUT	Inconnue	Scolaires Femmes	14,37	+0.4 m/s	14,05
77	 Elise Corthals	1 Open meeting - geen student	Cadets Femmes	14,50	-0.5 m/s	---
78	 Rose Nkake boluku	Inconnue	Scolaires Femmes	14,68	-0.5 m/s	---
79	 Ana Neckebroeck	1 Open meeting - geen student	Cadets Femmes	14,85	-0.5 m/s	14,86
80	 Nathalie Huynh	Université Catholique de Louvain	Seniors Femmes	14,88	-0.4 m/s	14,83
81	 Geike De Vriendt	1 Open meeting - geen student	Cadets Femmes	15,05	-0.5 m/s	14,89
	 Evelyn Huyghe	Universiteit Antwerpen	Seniors Femmes	DQ		14,68
	 Rachel Henno	HE Louvain en Hainaut	Seniors Femmes	DNS		---
	 May Lee Cooper	Université de Liège (site de Gembloux)	Seniors Femmes	DNS		12,77

Hommes- 800m

#	Nom	Club	Catégorie	Résultat	OBP
1	 Brent Soetens	Universiteit Gent	Seniors Hommes	1:53,02	1:53,23
2	 Victor Bettens	Hogeschool Gent	Seniors Hommes	1:53,47	1:54,75
3	 Joachim Bafort	Universiteit Gent	Seniors Hommes	1:53,72	1:54,28
4	 Korneel Weekers	Hogeschool UC Leuven	Seniors Hommes	1:54,54	1:54,80
5	 Thibau Van den Bussche	Arteveldehogeschool	Seniors Hommes	1:54,78	1:56,14
6	 Edouard Simon	Université Catholique de Louvain	Seniors Hommes	1:57,00	1:56,79
7	 Arne Boeykens	1 Open meeting - geen student	Seniors Hommes	1:57,54	1:56,54
8	 Dimitri Bertrand	HE de la Province de Liège	Seniors Hommes	1:57,76	1:56,59
9	 Reinbert Van Acker	1 Open meeting - geen student	Seniors Hommes	1:57,77	1:56,61
10	 Stanislav Driapko	1 Open meeting - geen student	Juniors Hommes	1:59,57	1:54,89
11	 Robin Soetens	1 Open meeting - geen student	Juniors Hommes	1:59,92	2:03,20
12	 Wouter Verstockt	1 Open meeting - geen student	Seniors Hommes	2:00,51	1:58,73
13	 Boris De Grelle	Université Catholique de Louvain	Seniors Hommes	2:02,16	 2:02,45
14	 Martijn Hus	Katholieke Universiteit Leuven	Seniors Hommes	2:02,49	2:01,00
15	 Bernard Laureys	Katholieke Universiteit Leuven	Seniors Hommes	2:02,52	1:59,28
16	 Jules Blanchart	1 Open meeting - geen student	Scolaires Hommes	2:02,62	2:04,60
17	 Laurens Blommaert	1 Open meeting - geen student	Scolaires Hommes	2:02,66	2:03,08
18	 Aurian Mathurin	Hogeschool West-Vlaanderen	Seniors Hommes	2:02,87	2:02,29
19	 Glen Smet	Katholieke Universiteit Leuven	Seniors Hommes	2:03,57	2:02,65
20	 Toon Vierbergen	1 Open meeting - geen student	Seniors Hommes	2:04,74	2:04,19
21	 Arjen De Meyer	Universiteit Gent	Seniors Hommes	2:05,51	2:05,39
22	 Maarten Vermaelen	Vrije Universiteit Brussel	Seniors Hommes	2:05,68	2:06,05
23	 Lucas Bastin	HE de Namur Liège Luxembourg	Seniors Hommes	2:06,67	2:09,15
24	 Corentin Beyaert	Vrije Universiteit Brussel	Seniors Hommes	2:07,17	2:07,81
25	 Nawfel Benouda	HE Léonard de Vinci	Seniors Hommes	2:07,87	2:05,19
26	 Geoffry Van De Velde	1 Open meeting - geen student	Seniors Hommes	2:08,73	2:09,73
27	 Cédric Van Den Berge	Inconnue	Masters Hommes	2:09,78	2:06,82
28	 Gabriël Lauwereys	Inconnue	Juniors Hommes	2:10,70	2:08,88
29	 Miguel Van de Sype	1 Open meeting - geen student	Seniors Hommes	2:15,25	---
30	 Arnaud Vermoesen	Inconnue	Cadets Hommes	2:15,45	2:17,16
31	 Basile De Vos	1 Open meeting - geen student	Cadets Hommes	2:16,91	2:18,75
32	 Seth Van Cauwenbergh	1 Open meeting - geen student	Cadets Hommes	2:19,35	---
33	 Ilano Broekaert	1 Open meeting - geen student	Cadets Hommes	2:22,17	2:21,70
34	 Loui De Bilde	1 Open meeting - geen student	Cadets Hommes	2:32,59	2:31,93
35	 André Goffart	HE Libre Mosane	Seniors Hommes	2:43,77	---
	 Stijn Van Nieuwenhove	Hogeschool Gent	Seniors Hommes	DNF	1:52,49

Dames- 800m

#	Nom	Club	Catégorie	Résultat	OBP
1	 Mariska Parewyck	Inconnue	Seniors Femmes	2:05,01	2:04,22
2	 Lucie Grandjean	Université Catholique de Louvain	Seniors Femmes	2:11,82	2:08,22
3	 Emma D'haene	Hogeschool Gent	Seniors Femmes	2:13,50	2:12,78
4	 Jacintha Cornelis	Universiteit Gent	Seniors Femmes	2:13,79	2:08,66
5	 Sophie Laloux	Université Catholique de Louvain -St Louis	Seniors Femmes	2:14,50	2:15,22
6	 Marine Joblin	HE Bruxelles - Brabant	Seniors Femmes	2:15,70	2:11,27
7	 Océane Kouassi Aka	Université Libre de Bruxelles	Seniors Femmes	2:17,73	2:17,52
8	 Esther Callebaut	1 Open meeting - geen student	Cadets Femmes	2:21,31	2:24,48
9	 Amélie Paulart	Université Catholique de Louvain	Juniors Femmes	2:21,79	2:20,86
10	 Josephine De Brouwer	Inconnue	Juniors Femmes	2:24,77	2:23,80
11	 Jente Van Droogenbroeck	Arteveldehogeschool	Seniors Femmes	2:29,16	2:29,14
12	 Isabelle Godefridi	1 Open meeting - geen student	Seniors Femmes	2:29,87	2:29,66
13	 Liesl Luysen	Universiteit Gent	Seniors Femmes	2:32,83	2:35,48
14	 Femke Ysewyn	Odisee Hogeschool	Seniors Femmes	2:34,92	2:25,35
15	 Ella Bauwens	1 Open meeting - geen student	Scolaires Femmes	2:36,94	2:31,44
16	 Alia Frahtia	Université Catholique de Louvain	Seniors Femmes	2:40,50	---
17	 Hanne Van de Casseye	1 Open meeting - geen student	Seniors Femmes	2:42,60	2:36,68
18	 Fran Bauwens	1 Open meeting - geen student	Cadets Femmes	2:46,92	---
19	 Samantha Geeroms	Thomas More	Seniors Femmes	2:49,10	2:45,73
20	 Alicia De Grave	1 Open meeting - geen student	Cadets Femmes	2:50,37	2:53,19
21	 Kendra Audenaert	1 Open meeting - geen student	Seniors Femmes	2:50,69	---
22	 Hasse Mertens	Universiteit Gent	Juniors Femmes	2:50,74	2:30,34
23	 Larissa Huyck	Universiteit Gent	Juniors Femmes	2:51,55	2:34,92
24	 Veerle Van Campenhout	1 Open meeting - geen student	Masters Femmes	2:52,18	2:50,45
25	 Dorien Van Doorselaere	1 Open meeting - geen student	Cadets Femmes	2:53,09	---
26	 Faustine Viart	Université de Namur	Seniors Femmes	2:56,59	2:54,82
27	 Louise Devloo	Universiteit Gent	Seniors Femmes	3:00,67	---
28	 Lutgard De Clercq	Inconnue	Seniors Femmes	3:03,38	2:55,71

Hommes- 400m

#	Nom	Club	Catégorie	Résultat	OBP
1	 Robin Vanderbemden	Université de Liège (site de Liège)	Seniors Hommes	46,68	 46,00
2	 Dylan Owusu	1 Open meeting - geen student	Seniors Hommes	48,36	48,00
3	 Ruben Verheyden	Universiteit Gent	Seniors Hommes	48,96	48,97
4	 Mathys Latinne	Université Catholique de Louvain	Seniors Hommes	48,97	49,91
5	 Gaëtan Chiroux	1 Open meeting - geen student	Seniors Hommes	49,71	49,66
6	 Clément Hendrick	Université Libre de Bruxelles	Seniors Hommes	49,74	48,38
7	 Louis Smeets	1 Open meeting - geen student	Scolaires Hommes	49,88	50,84
8	 Wout Van Hoof	Universiteit Gent	Juniors Hommes	50,33	51,10
9	 Robbert Heylen	1 Open meeting - geen student	Seniors Hommes	50,40	48,90
10	 Hugues Kabuya	HE Francisco Ferrer	Seniors Hommes	50,90	49,97
11	 Jérôme Ruth	1 Open meeting - geen student	Seniors Hommes	51,43	49,59
12	 Rob Van den Bogaert	Hogeschool Gent	Seniors Hommes	52,20	50,95
13	 Jenten Goeteyn	Inconnue	Seniors Hommes	 52,33	50,94
14	 Siebe Hauttekeete	Universiteit Gent	Juniors Hommes	 52,33	52,40
15	 Simon Dennetiere	Inconnue	Seniors Hommes	52,40	 52,65
16	 Christof Pieters	1 Open meeting - geen student	Masters Hommes	52,71	52,43
17	 Antoine Bodart	1 Open meeting - geen student	Seniors Hommes	52,78	52,75
18	 Pierre Laloux	Université Catholique de Louvain	Seniors Hommes	52,86	52,25
19	 Quentin Dujardin	1 Open meeting - geen student	Seniors Hommes	52,88	54,44
20	 Hendrik Heylen	Katholieke Universiteit Leuven	Seniors Hommes	53,09	---
21	 Emiel Dieussaert	Universiteit Gent	Seniors Hommes	53,48	53,58
22	 Lois Dejasse	Université Catholique de Louvain	Juniors Hommes	53,64	53,07
23	 Pieter Vandenborne	1 Open meeting - geen student	Seniors Hommes	53,80	52,89
24	 Luka Afschrift	1 Open meeting - geen student	Scolaires Hommes	54,02	53,12
25	 Louis Pecheur	Université Catholique de Louvain	Seniors Hommes	54,21	54,17
26	 Tiago Dekie	1 Open meeting - geen student	Cadets Hommes	54,25	53,74
27	 Jonas Huyck	Katholieke Universiteit Leuven	Seniors Hommes	54,35	54,69
28	 Luka Claeys	Inconnue	Juniors Hommes	54,38	52,47
29	 Joris Paquot	Erasmus Hogeschool Brussel	Juniors Hommes	54,62	55,88
30	 Souhaïb Azzouz	Université Catholique de Louvain	Seniors Hommes	54,64	51,73
31	 Simon Vanneste	1 Open meeting - geen student	Seniors Hommes	54,79	---
32	 Kobe Lauwereys	1 Open meeting - geen student	Juniors Hommes	55,53	57,44
33	 Tibo Verstockt	1 Open meeting - geen student	Seniors Hommes	55,64	56,34
34	 Oscar Mues	Katholieke Universiteit Leuven	Scolaires Hommes	55,72	54,72
35	 Nawfel Benouda	HE Léonard de Vinci	Seniors Hommes	56,25	54,91
36	 Antonio Jara	1 Open meeting - geen student	Masters Hommes	57,63	57,40

Dames- 400m

#	Nom	Club	Catégorie	Résultat	OBP
1	 Benedikt Tchimou	Inconnue	Seniors Femmes	55,31	55,15
2	 Geraldine Dheur	Université Catholique de Louvain	Seniors Femmes	55,43	56,56
3	 Jana Kluskens	Hogeschool Gent	Juniors Femmes	55,71	55,64
4	 Cloë Van der Meulen	Universiteit Gent	Seniors Femmes	55,76	---
5	 Marie Fickers	1 Open meeting - geen student	Seniors Femmes	56,25	56,35
6	 Jenna De Smet	Universiteit Gent	Seniors Femmes	56,92	57,44
7	 Jitse Steenmans	Katholieke Universiteit Leuven	Seniors Femmes	57,40	58,00
8	 Ine Hugaerts	Katholieke Universiteit Leuven	Seniors Femmes	57,40	57,96
9	 Claire Jacobs	Université Catholique de Louvain	Juniors Femmes	57,59	57,86
10	 Hanna Vereecke	Vrije Universiteit Brussel	Seniors Femmes	57,67	56,85
11	 Hanne Maudens	Universiteit Gent	Seniors Femmes	58,35	53,06
12	 Myrthe Baeten	1 Open meeting - geen student	Scolaires Femmes	58,51	58,47
13	 Amelie Sonneville	Universiteit Gent	Juniors Femmes	58,94	58,63
14	 Jienity De kler	Universiteit Gent	Seniors Femmes	59,05	---
15	 Ilkje De Vlieger	Vrije Universiteit Brussel	Seniors Femmes	59,09	59,40
16	 Ines Gbedassi	Hogeschool UC Leuven	Seniors Femmes	59,10	57,80
17	 Clara De Vare	Katholieke Universiteit Leuven	Juniors Femmes	59,16	58,09
18	 Janne Hermans	1 Open meeting - geen student	Scolaires Femmes	59,34	59,43
19	 Hannelore Heymans	1 Open meeting - geen student	Juniors Femmes	1:00,04	59,53
20	 Hege Michiels	Inconnue	Seniors Femmes	1:00,07	59,18
21	 Timea Huyck	Universiteit Gent	Juniors Femmes	1:00,30	1:00,19
22	 Jolein De Rocker	Hogeschool Gent	Seniors Femmes	1:00,52	1:01,54
23	 Eva Jaspers	1 Open meeting - geen student	Scolaires Femmes	1:01,00	1:03,27
24	 Sara Wyns	Vrije Universiteit Brussel	Seniors Femmes	1:01,25	59,58
25	 Elise Léonard	1 Open meeting - geen student	Scolaires Femmes	1:01,54	1:02,20
26	 Robin Degrève	Universiteit Gent	Seniors Femmes	1:02,20	57,02
27	 Anke Sirjacobs	1 Open meeting - geen student	Scolaires Femmes	1:02,29	1:02,15
28	 Anouk De Smet	1 Open meeting - geen student	Cadets Femmes	1:03,23	1:03,32
29	 Ellen Samassi Scott	1 Open meeting - geen student	Cadets Femmes	1:03,39	1:06,19
30	 Elsa De Greef	Université Catholique de Louvain	Seniors Femmes	1:03,56	1:02,22
31	 Chloë Scheirlinckx	Université Catholique de Louvain	Seniors Femmes	1:03,67	1:04,17
32	 Miet Parmentier	1 Open meeting - geen student	Seniors Femmes	1:03,93	1:04,35
33	 Line Lauwers	1 Open meeting - geen student	Cadets Femmes	1:04,27	1:06,09
34	 Clémence Colassin	Université Catholique de Louvain	Seniors Femmes	1:05,58	1:04,80
35	 Stephanie Detaellaenaere	1 Open meeting - geen student	Seniors Femmes	1:05,70	1:05,65
36	 Sybil Vandamme	Ecole Pratiques des Hautes études Commerciales	Seniors Femmes	1:06,84	1:03,97
37	 Marlies Ceulemans	1 Open meeting - geen student	Seniors Femmes	1:08,09	1:06,42
38	 Nina Michiels	1 Open meeting - geen student	Cadets Femmes	1:09,99	1:08,32
39	 Cindy D'Hondt	Universiteit Gent	Seniors Femmes	1:12,50	---
	 Laure Van Den Abeele	Université Catholique de Louvain	Seniors Femmes	DNF	57,88

Hommes- 200m











#	Nom	Club	Catégorie	Résultat		OBP
1	 Adrien Devriendt	Inconnue	Seniors Hommes	21,11	-0.5 m/s	21,41
2	 Lionel Halleux	Université Catholique de Louvain	Seniors Hommes	21,63	-0.5 m/s	21,59
3	 Geoffrey Jacques	HE Libre Mosane	Seniors Hommes	21,67	-0.5 m/s	21,58
4	 Antoine Snyders	HE Libre Mosane	Seniors Hommes	21,68	-0.5 m/s	21,26
5	 Camille Snyders	HE de la Province de Liège	Seniors Hommes	21,74	-0.5 m/s	21,66
6	 Xavier Rousseau	1 Open meeting - geen student	Scolaires Hommes	22,00	-0.5 m/s	 21,98
7	 Clément Brunin	1 Open meeting - geen student	Seniors Hommes	22,03	-0.5 m/s	21,90
8	 Floran Dehout	HE Louvain en Hainaut	Seniors Hommes	22,09	-0.5 m/s	21,99
9	 Dries Van Nieuwenhove	Hogeschool Gent	Seniors Hommes	22,13	-0.5 m/s	21,73
10	 Jasper Annys	Hogeschool VIVES	Seniors Hommes	22,21	-0.5 m/s	21,93
11	 Sébastien Lins	Inconnue	Seniors Hommes	 22,31	-0.5 m/s	21,53
12	 Wout Bex	Universiteit Gent	Seniors Hommes	 22,31	-1.2 m/s	22,07
13	 Meindert Caudron	Inconnue	Juniors Hommes	22,35	-0.5 m/s	21,85
14	 Tibe Temmerman	Inconnue	Juniors Hommes	22,40	-1.2 m/s	22,47
15	 Bjirsen Deherder	1 Open meeting - geen student	Seniors Hommes	22,42	-0.7 m/s	22,66
16	 Gautier Brichet	HE Léonard de Vinci	Seniors Hommes	22,46	-0.7 m/s	22,93
17	 Marko Medan	Université Libre de Bruxelles	Seniors Hommes	22,47	-1.2 m/s	22,09
18	 Jitse Mievis	Erasmus Hogeschool Brussel	Seniors Hommes	22,50	-0.5 m/s	21,83
19	 Stijn Van der Vreken	Hogeschool Gent	Juniors Hommes	22,56	-1.2 m/s	22,02
20	 Quentin Chevallier-Appert	1 Open meeting - geen student	Scolaires Hommes	22,57	-0.7 m/s	22,76
21	 Thomas Van Ingelgem	1 Open meeting - geen student	Masters Hommes	22,66	-1.2 m/s	22,31
22	 Jordy Van Lierde	Universiteit Gent	Seniors Hommes	22,70	-0.4 m/s	23,32
23	 Quentin Hoffken	1 Open meeting - geen student	Juniors Hommes	22,74	-0.7 m/s	22,84
24	 Siemen Masure	Universiteit Gent	Seniors Hommes	22,77	-0.5 m/s	21,85
25	 Charles Hamaide	1 Open meeting - geen student	Seniors Hommes	22,88	-0.7 m/s	22,88
26	 Storm Tuyls	Hogeschool Gent	Seniors Hommes	22,92	-1.2 m/s	22,35
27	 Jarne Mariën	Universiteit Antwerpen	Juniors Hommes	23,07	-0.4 m/s	22,94
28	 Alexander Van Vliet	Universiteit Gent	Juniors Hommes	23,10	+1.3 m/s	 23,95
29	 Jean-Charles Nsangolo	1 Open meeting - geen student	Seniors Hommes	23,11	-0.4 m/s	23,38
30	 Laurens Francois	Universiteit Gent	Seniors Hommes	23,15	-0.7 m/s	22,69
31	 Jasper Vermaelen	1 Open meeting - geen student	Juniors Hommes	23,26	+1.3 m/s	23,58
32	 Simon Cotton	HE Louvain en Hainaut	Seniors Hommes	23,37	-1.2 m/s	22,53
33	 Driss Vergels	Inconnue	Juniors Hommes	23,45	+1.3 m/s	23,62
34	 Arthur Agbassa	Inconnue	Juniors Hommes	23,47	-0.4 m/s	23,12
35	 Mateo Loforte	HE Libre Mosane	Seniors Hommes	23,53	+1.3 m/s	23,77
36	 Stef Ruysinck	1 Open meeting - geen student	Scolaires Hommes	23,67	+1.3 m/s	23,54
37	 Gertjan Demeur	1 Open meeting - geen student	Seniors Hommes	23,68	+1.3 m/s	23,58
38	 Titouan Danno	Université Libre de Bruxelles	Seniors Hommes	23,81	+0.6 m/s	—
39	 Ethan Sébastien Dumont	HE Provinciale du Hainaut-Condorcet	Seniors Hommes	24,14	+0.5 m/s	 24,73
40	 Ludovic Fenaux	1 Open meeting - geen student	Masters Hommes	24,16	-0.4 m/s	23,42
41	 Melchizedek Agyemang	Hogeschool Gent	Seniors Hommes	24,31	+1.3 m/s	24,19
42	 Jakob Verleyen	1 Open meeting - geen student	Cadets Hommes	24,56	+0.6 m/s	26,32
43	 Louis Pecheur	Université Catholique de Louvain	Seniors Hommes	24,65	+1.3 m/s	24,09
44	 Luca D'hooghe	1 Open meeting - geen student	Cadets Hommes	24,69	+0.5 m/s	24,85
45	 Jan Matthys	Universiteit Gent	Seniors Hommes	24,81	+0.5 m/s	25,51
46	 Jonas De smet	Inconnue	Seniors Hommes	24,89	-0.5 m/s	21,47
47	 Noël Ackaert	1 Open meeting - geen student	Masters Hommes	24,92	+0.5 m/s	25,24
48	 Wouter Vander Mijnsbrugge	1 Open meeting - geen student	Seniors Hommes	25,02	+0.5 m/s	25,14
49	 Benjamin Jolis	Université de Liège (site de Liège)	Seniors Hommes	25,32	+0.6 m/s	—
50	 Joppe Gutschoven	1 Open meeting - geen student	Scolaires Hommes	25,46	+0.5 m/s	26,21
51	 Tristan Bistrussu	1 Open meeting - geen student	Juniors Hommes	25,73	+0.6 m/s	26,70
52	 Pascal Rijdant	1 Open meeting - geen student	Masters Hommes	26,46	+0.5 m/s	26,07
53	 MAXIME Piedboeuf	HE de la Province de Liège	Juniors Hommes	26,95	+0.6 m/s	27,17
54	 Gil Talon	Inconnue	Seniors Hommes	27,10	+0.6 m/s	27,77
55	 Aurélien Belle	HE Louvain en Hainaut	Seniors Hommes	27,97	+0.6 m/s	—
56	 Michaël De Prins	Karel de Grote Hogeschool	Seniors Hommes	28,27	+0.6 m/s	27,84
	 Reginald Beele	Inconnue	Seniors Hommes	DNS		22,98
	 Nicolas Léonard	HE Léonard de Vinci	Seniors Hommes	DNS		22,62
	 Ali Lachkar	Université Libre de Bruxelles	Seniors Hommes	DNS		23,22
	 Matisse Barbio	1 Open meeting - geen student	Juniors Hommes	DNS		25,08
	 Enguerran Bossicard	HE Louvain en Hainaut	Seniors Hommes	DNF		21,71
	 Hadrien Wimlot	Université Libre de Bruxelles	Seniors Hommes	DNF		22,66
	 Olivier Baro	1 Open meeting - geen student	Seniors Hommes	DNF		23,24
	 Dorian André	1 Open meeting - geen student	Seniors Hommes	DNF		22,62

Dames- 200m

#	Nom	Club	Catégorie	Résultat		OBP
1	 Rani Vincke	Universiteit Gent	Seniors Femmes	23,97	-0.8 m/s	23,72
2	 Janie De Naeyer	Universiteit Antwerpen	Seniors Femmes	24,08	-0.6 m/s	 24,76
3	 Emma Broze	HE Léonard de Vinci	Seniors Femmes	24,58	-0.8 m/s	24,67
4	 Anouchka Kadiamba	Hogeschool Gent	Seniors Femmes	24,67	-0.8 m/s	24,55
5	 Cloe CHAVEPEYER	HE Louvain en Hainaut	Seniors Femmes	24,70	-0.8 m/s	24,10
6	 Sarah-Daisy Tshiamala-Bitota	HE Louvain en Hainaut	Seniors Femmes	24,77	-0.8 m/s	24,23
7	 Noor Vermeiren	1 Open meeting - geen student	Juniors Femmes	24,82	-0.6 m/s	25,12
8	 Camille Sonnevile	1 Open meeting - geen student	Scolaires Femmes	24,83	-0.6 m/s	24,91
9	 Libelia Vincke	Hogeschool West-Vlaanderen	Seniors Femmes	24,93	-0.8 m/s	24,72
10	 Eline Claeys	Universiteit Gent	Seniors Femmes	25,06	-0.8 m/s	24,54
11	 Tinne Vertongen	1 Open meeting - geen student	Juniors Femmes	25,14	-0.8 m/s	24,27
12	 Manon De Marez	1 Open meeting - geen student	Seniors Femmes	25,31	+0.9 m/s	25,69
13	 Iris Bollengier	1 Open meeting - geen student	Scolaires Femmes	25,35	-0.5 m/s	26,08
14	 Zoë Willemyns	1 Open meeting - geen student	Scolaires Femmes	25,50	+0.9 m/s	25,79
15	 Nona Heyvaert	1 Open meeting - geen student	Juniors Femmes	25,80	-0.6 m/s	25,53
16	 Chloé Violle	Université de Liège (site de Liège)	Seniors Femmes	25,82	-0.5 m/s	25,88
17	 Dora De Haseleer	Université Catholique de Louvain	Seniors Femmes	25,95	-0.6 m/s	25,68
18	 Laure Van Den Abeele	Université Catholique de Louvain	Seniors Femmes	25,98	+0.9 m/s	25,73
19	 Jutta Decock	Katholieke Universiteit Leuven	Seniors Femmes	26,01	-0.2 m/s	26,32
20	 Caroline Vanhamme	Université Catholique de Louvain	Seniors Femmes	26,07	-0.5 m/s	26,00
21	 Ellen Anckaert	1 Open meeting - geen student	Scolaires Femmes	26,09	-0.2 m/s	26,34
22	 Laureen Cugnet-Evans	Université Catholique de Louvain	Seniors Femmes	26,12	+0.9 m/s	25,86
23	 Emeline Lippens	1 Open meeting - geen student	Scolaires Femmes	26,20	-0.6 m/s	25,37
24	 Chloë O'Shea	Université Catholique de Louvain	Seniors Femmes	26,21	-0.5 m/s	 26,07
25	 Bente Van Ingelgem	1 Open meeting - geen student	Cadets Femmes	 26,35	-0.5 m/s	26,79
26	 Valentine Anyanwu	Université Catholique de Louvain	Juniors Femmes	 26,35	-0.5 m/s	26,12

27	 Lisa De Troyer	Hogeschool Gent	Juniors Femmes	26,37	-0.5 m/s	26,72
28	 Emma Hiel	Arteveldehogeschool	Seniors Femmes	26,37	-0.5 m/s	26,04
29	 Lotte Van der Vreken	Universiteit Gent	Seniors Femmes	26,38	-0.2 m/s	26,37
30	 Eléa Godeau	1 Open meeting - geen student	Juniors Femmes	26,40	+0.9 m/s	25,85
31	 Zina Looverie	1 Open meeting - geen student	Scolaires Femmes	26,51	-0.2 m/s	26,63
32	 Yelena Boone	1 Open meeting - geen student	Juniors Femmes	26,54	+0.9 m/s	25,83
33	 Amélie Sonnevillie	Universiteit Gent	Juniors Femmes	26,60	-0.2 m/s	26,25
34	 Lisa Van Renterghem	Hogeschool Gent	Seniors Femmes	26,60	-0.2 m/s	26,68
35	 Anaëlle Rousseau	1 Open meeting - geen student	Scolaires Femmes	26,67	-0.2 m/s	26,42
36	 Nande De Kimpe	1 Open meeting - geen student	Scolaires Femmes	26,72	-0.5 m/s	26,21
37	 Lorien Aelbrecht	1 Open meeting - geen student	Juniors Femmes	26,76	-0.5 m/s	27,06
38	 Saartje Lansén	1 Open meeting - geen student	Scolaires Femmes	26,92	+0.9 m/s	25,71
39	 Lore Van den Bremt	Arteveldehogeschool	Seniors Femmes	26,93	-0.5 m/s	26,72
40	 Elisa Desmet	Hogeschool VIVES	Seniors Femmes	26,93	-0.2 m/s	26,66
41	 Emma Frans	HE Libre Mosane	Seniors Femmes	27,06	-0.5 m/s	27,28
42	 Yuna Hermans	Karel de Grote Hogeschool	Juniors Femmes	27,06	-0.5 m/s	27,11
43	 Estelle Jennes	Université de Liège (site de Liège)	Juniors Femmes	27,07	-0.5 m/s	27,33
44	 Anne-Ramon Cole	Vrije Universiteit Brussel	Juniors Femmes	27,31	-0.5 m/s	27,22
45	 Iris Lefevère	1 Open meeting - geen student	Scolaires Femmes	27,60	-1.0 m/s	28,66
46	 France Vande Cavey	Inconnue	Juniors Femmes	27,61	-0.5 m/s	26,84
47	 Riet Van Aerschot	Inconnue	Juniors Femmes	27,70	-0.5 m/s	27,22
48	 Miek Lagaeyse	Universiteit Gent	Juniors Femmes	27,94	-0.5 m/s	27,93
49	 Camille Chauvin	HE Provinciale du Hainaut-Condorcet	Seniors Femmes	27,97	-0.7 m/s	---
50	 Elise Romeyns	Inconnue	Scolaires Femmes	28,16	-0.5 m/s	28,31
51	 Alessia Petrella	Universiteit Gent	Seniors Femmes	28,23	-1.0 m/s	28,99
52	 Myrthe Gobert	Universiteit Antwerpen	Seniors Femmes	28,45	-0.5 m/s	27,77
53	 Clara Ruzziconi	HE Libre Mosane	Seniors Femmes	28,47	-1.0 m/s	28,49
54	 Kaat Smet	1 Open meeting - geen student	Cadets Femmes	28,58	-1.0 m/s	28,76
55	 Charlotte Kinable	Katholieke Universiteit Leuven	Seniors Femmes	28,61	-0.5 m/s	26,23
56	 Cailtin Verleysen	Karel de Grote Hogeschool	Juniors Femmes	28,64	-0.5 m/s	27,70
57	 Jasmine Fonck	1 Open meeting - geen student	Scolaires Femmes	28,87	-1.0 m/s	28,99
58	 Orligane Manteau	HE Provinciale du Hainaut-Condorcet	Seniors Femmes	28,90	-1.0 m/s	29,36
59	 Lucca Delos	1 Open meeting - geen student	Scolaires Femmes	29,30	-0.6 m/s	29,84
60	 Lore REMBAUT	Inconnue	Scolaires Femmes	29,32	-1.0 m/s	28,62
61	 Evelyne Huyghe	Universiteit Antwerpen	Seniors Femmes	29,51	-0.6 m/s	29,93
62	 Sélène Van Wijnendaele	1 Open meeting - geen student	Cadets Femmes	29,60	-0.6 m/s	29,69
63	 Rosanne Verbruggen	Katholieke Universiteit Leuven	Seniors Femmes	29,61	-0.7 m/s	30,83
64	 Julia Alegre	Université de Liège (site de Liège)	Seniors Femmes	29,74	-0.6 m/s	29,51
65	 Norah De Jaeger	Inconnue	Cadets Femmes	29,78	-0.6 m/s	29,56
66	 Elise Corthals	1 Open meeting - geen student	Cadets Femmes	30,12	-0.7 m/s	30,86
67	 Ana Neckebroeck	1 Open meeting - geen student	Cadets Femmes	30,25	-0.7 m/s	30,99
68	 Nathalie Huynh	Université Catholique de Louvain	Seniors Femmes	30,29	-0.7 m/s	30,94
69	 Ulrike Piekanowski	1 Open meeting - geen student	Scolaires Femmes	30,30	-0.6 m/s	29,94
70	 Saar Van hoof	1 Open meeting - geen student	Juniors Femmes	30,67	-0.6 m/s	30,17
71	 Geike De Vriendt	1 Open meeting - geen student	Cadets Femmes	31,15	-0.7 m/s	31,08
	 Monica Peñalver Garcia	HE Léonard de Vinci	Seniors Femmes	DNS		---
	 Kyra Janssens	Vrije Universiteit Brussel	Seniors Femmes	DNS		 25,69
	 Sterre Provost	1 Open meeting - geen student	Scolaires Femmes	DNS		24,92
	 Chloe Philippe	1 Open meeting - geen student	Scolaires Femmes	DNS		25,72

Hommes- 400m haies

Série 1							
5	 1413 Daniel Segers	Inconnue	Seniors Hommes	91.4cm	53,46	1	53,32
3	 2490 Nils Romswinkel	Universiteit Gent	Seniors Hommes	91.4cm	55,07	2	55,65
4	 1437 Simon Lavigne	HE de Namur Liège Luxembourg	Seniors Hommes	91.4cm	56,72	3	54,11
6	 3573 Richard F Mayango	Thomas More	Seniors Hommes	91.4cm	57,13	4	58,54
7	 9000 Eduard Goffart Winkin	Katholieke Universiteit Leuven	Seniors Hommes	91.4cm	1:01,40	5	---
Série 2							
6	 9010 Christopher Hassaine	HE Provinciale du Hainaut-Condorcet	Seniors Hommes	91.4cm	54,53	1	---
7	 184 Alexandre Otjacques	Université Libre de Bruxelles	Juniors Hommes	91.4cm	55,17	2	---
5	 266 Arthur Agbassa	Inconnue	Juniors Hommes	91.4cm	1:00,93	3	---
3	 830 Milan De Hertogh	Katholieke Universiteit Leuven	Juniors Hommes	91.4cm	1:03,38	4	---
4	 722 Eli Timmerman	1 Open meeting - geen student	Juniors Hommes	91.4cm	1:04,21	5	---

#	Nom	Club	Catégorie	Hauteur des...	Résultat	OBP
1	Daniel Segers	Inconnue	Seniors Hommes	91.4cm	53,46	53,32
2	Christopher Hassaine	HE Provinciale du Hainaut-Condorcet	Seniors Hommes	91.4cm	54,53	---
3	Nils Romswinkel	Universiteit Gent	Seniors Hommes	91.4cm	55,07	55,65
4	Alexandre Otjacques	Université Libre de Bruxelles	Juniors Hommes	91.4cm	55,17	---
5	Simon Lavigne	HE de Namur Liège Luxembourg	Seniors Hommes	91.4cm	56,72	54,11
6	Richard F Mayango	Thomas More	Seniors Hommes	91.4cm	57,13	58,54
7	Arthur Agbassa	Inconnue	Juniors Hommes	91.4cm	1:00,93	---
8	Eduard Goffart Winkin	Katholieke Universiteit Leuven	Seniors Hommes	91.4cm	1:01,40	---
9	Milan De Hertogh	Katholieke Universiteit Leuven	Juniors Hommes	91.4cm	1:03,38	---
10	Eli Timmerman	1 Open meeting - geen student	Juniors Hommes	91.4cm	1:04,21	---

Dames- 400m haies

Série 1						
5	153 Zélie Boucquey	Inconnue	Juniors Femmes	76.2cm	1:02,49	1 1:03,77
4	2455 Loike Vierendeels	Universiteit Gent	Seniors Femmes	76.2cm	1:02,86	2 1:03,66
6	1119 Charline LEFEVRE	Université de Liège (site de Liège)	Seniors Femmes	76.2cm	1:03,46	3 1:04,57
7	1795 Audrey Van der Haegen	Hogeschool Gent	Seniors Femmes	76.2cm	1:06,15	4 1:06,25
3	806 Maya Vanhee	Arteveldehogeschool	Juniors Femmes	76.2cm	1:06,69	5 1:05,31
Série 2						
6	3542 Allegra Gürsoy	1 Open meeting - geen student	Scolaires Femmes	76.2cm	1:05,56	1 1:08,56
3	715 Jade Cowie	Inconnue	Juniors Femmes	76.2cm	1:08,21	2 1:06,35
5	1895 Anke Vermaelen	Katholieke Universiteit Leuven	Seniors Femmes	76.2cm	1:08,60	3 1:08,06
4	1455 Eline Fauconnier	Université Catholique de Louvain	Seniors Femmes	76.2cm	1:09,06	4 1:07,44
#	Nom	Club	Catégorie	Hauteur des...	Résultat	OBP
1	Zélie Boucquey	Inconnue	Juniors Femmes	76.2cm	1:02,49	1:03,77
2	Loike Vierendeels	Universiteit Gent	Seniors Femmes	76.2cm	1:02,86	1:03,66
3	Charline LEFEVRE	Université de Liège (site de Liège)	Seniors Femmes	76.2cm	1:03,46	1:04,57
4	Allegra Gürsoy	1 Open meeting - geen student	Scolaires Femmes	76.2cm	1:05,56	1:08,56
5	Audrey Van der Haegen	Hogeschool Gent	Seniors Femmes	76.2cm	1:06,15	1:06,25
6	Maya Vanhee	Arteveldehogeschool	Juniors Femmes	76.2cm	1:06,69	1:05,31
7	Jade Cowie	Inconnue	Juniors Femmes	76.2cm	1:08,21	1:06,35
8	Anke Vermaelen	Katholieke Universiteit Leuven	Seniors Femmes	76.2cm	1:08,60	1:08,06
9	Eline Fauconnier	Université Catholique de Louvain	Seniors Femmes	76.2cm	1:09,06	1:07,44

Hommes – 4 x 100m

#	Équipe relais	Club	N...	Athlete 1	Athlete 2	Athlete 3	Athlete 4	Catégorie	Résu...	O...
1	HELHa Sport	HE Louvain en Hainaut	4	T. Rositano	E. Bossicard	F. Dehout	S. Cotton	Seniors Hommes	42,53	---
2	KAAG	1 Open meeting - geen student	4	M. Nevejans	F. Coene	L. Wauters	A. Barbio	Scolaires Hommes	43,31	---
3	UCL2	Université Catholique de Louvain	4	M. Zgajewski	L. Iker	N. Koch	F. De Radigües	Seniors Hommes	45,11	---
4	Alle Cat mannen Vlierzele	1 Open meeting - geen student	4	E. Van Bleyenbergh	J. Verschuere	S. Ruysinck	J. Schollaert	Seniors Hommes	45,27	---
5	Schol A Jongens vlierzele	1 Open meeting - geen student	4	V. De Spiegeleire	S. Wageman	J. Claus	R. Van Hoorde	Scolaires Hommes	46,57	---

Dames – 4 x 100m

#	Équipe relais	Club	N...	Athlete 1	Athlete 2	Athlete 3	Athlete 4	Catégorie	Résu...	O...
1	Schol A meisjes vlierzele	1 Open meeting - geen student	4	L. Van De Wiele	I. Bollengier	A. Sirjacobs	U. Pieknowski	Scolaires Femmes	52,13	---
2	Kad A meisjes Vlierzele	Inconnue	4	M. Van Britsom	K. Smet	M. Heirman	E. Corthals	Cadets Femmes	53,74	---
3	VUB 4x100	Vrije Universiteit Brussel	4	K. Janssens	B. Waerzeggers	H. Chiara	S. Wyns	Seniors Femmes	54,52	---
4	Alle catg vrouwen Vlierzele	1 Open meeting - geen student	4	L. REMBAUT	L. Delos	J. Fonck	H. Everaert	Seniors Femmes	55,50	---
5	Kad B meisjes vlierzele	1 Open meeting - geen student	4	G. De Vriendt	A. Everaert	A. Neckebroeck	S. Van Wijnendaele	Cadets Femmes	56,59	---

Hommes – 4 x 400m

#	Équipe re...	Club	N...	Athlete 1	Athlete 2	Athlete 3	Athlete 4	Catégorie	Résultat	O...
1	UCL 1	Université Catholique de Louvain	4	M. Zgajewski	B. De Grelle	V. Mullens	L. Dejasse	Seniors Hommes	3:37,83	---
2	UCL2	Université Catholique de Louvain	4	M. Azhigaliev	L. Pecheur	S. Fauconnier	S. Azzouz	Seniors Hommes	3:41,45	---
3	ULB	Université Libre de Bruxelles	4	S. Brial	N. Zampieri	P. Kerrand	M. Coiffé	Seniors Hommes	3:49,81	---

Dames – 4 x 400m

#	Équipe re...	Club	No...	Athlete 1	Athlete 2	Athlete 3	Athlete 4	Catégorie	Résultat	OBP
1	UCL1	Université Catholique de Louvain	4	L. Hübinger	A. Frahtia	M. Mazzoli	G. Louize	Seniors Femmes	4:48,24	---

Hommes- Lancer du poids

#	Nom	Club	Catégorie	Poids	P 1	P 2	P 3	P 4	P 5	P 6	Résu...	OBP
1	Andreas De Lathauwer	Odisee Hogeschool	Seniors Hommes	7.26kg	X	15,87	16,57	X	16,82	16,80	16,82	18,02
2	Wietse Vander Schelde	Katholieke Universiteit Leuven	Seniors Hommes	7.26kg	X	13,55	14,30	14,52	15,07	X	15,07	14,52
3	Leander Casteels	Hogeschool Gent	Seniors Hommes	7.26kg	13,21	13,77	X	13,34	X	X	13,77	14,53
4	Arnaud De Cremer	Universiteit Gent	Seniors Hommes	7.26kg	13,26	13,59	X	X	X	X	13,59	14,47
5	Jannes Boonen	Inconnue	Seniors Hommes	7.26kg	12,24	12,49	X	X	X	X	12,49	13,78
6	Joris Willems	1 Open meeting - geen student	Juniors Hommes	7.26kg	10,06	10,74	10,59	11,28	11,33	11,65	11,65	11,00
7	Dylan Volckaert	Universiteit Gent	Seniors Hommes	7.26kg	11,35	11,00	10,79	X	X	X	11,35	11,50
8	Dries Van de Vyver	Inconnue	Seniors Hommes	7.26kg	9,90	9,96	10,43	10,48	10,75	10,71	10,75	10,10
9	Sven Vereecken	Universiteit Gent	Seniors Hommes	7.26kg	8,82	9,23	9,81				9,81	10,43
10	Jelle Daems	Artesis Plantijn Hogeschool Antwerpen	Juniors Hommes	7.26kg	7,31	9,49	X				9,49	---
11	Riyaad El Amrani	Artesis Plantijn Hogeschool Antwerpen	Seniors Hommes	7.26kg	7,87	7,88	7,82				7,88	7,63
12	Jens Verduyckt	Universiteit Gent	Seniors Hommes	7.26kg	7,84	7,04	7,01				7,84	---
13	Benjamin Jolis	Université de Liège (site de Liège)	Seniors Hommes	7.26kg	6,79	7,35	6,33				7,35	---

Dames- Lancer du poids

#	Nom	Club	Catégorie	P...	P 1	P 2	P 3	P 4	P 5	P 6	Résu...	OBP
1	Florence Boeynaems	Artesis Plantijn Hogeschool Antwerpen	Seniors Femmes	4kg	12,80	11,99	13,08	12,49	12,55	13,46	13,46	13,98
2	Cassandre Evans	HE de la Province de Liège	Seniors Femmes	4kg	12,55	12,23	12,09	12,35	12,30	13,13	13,13	13,65
3	Hanne Maudens	Universiteit Gent	Seniors Femmes	4kg	12,52	12,87	12,57	11,94	X	X	12,87	13,55
4	Sena Tay	Inconnue	Juniors Femmes	4kg	11,74	X	12,34	12,07	12,72	12,18	12,72	12,73
5	Kelly Van Petegem	1 Open meeting - geen student	Seniors Femmes	4kg	11,27	11,11	11,76	X	11,34	12,39	12,39	11,36
6	Tyra Steur	Universiteit Gent	Seniors Femmes	4kg	11,53	11,68	11,66	11,87	11,88	12,03	12,03	12,60
7	Sara Van Hoyweghen	Universiteit Gent	Seniors Femmes	4kg	12,02	11,56	X	X	X	11,57	12,02	12,14
8	Gretel Canters	Hogeschool PXL	Seniors Femmes	4kg	11,87	11,61	11,96	-	-	-	11,96	12,47
9	Lien Rubbrecht	Universiteit Gent	Seniors Femmes	4kg	10,93	10,49	10,61				10,93	11,83
10	Maxence Coquyt	Universiteit Gent	Seniors Femmes	4kg	9,58	9,68	10,11				10,11	11,77
11	Phebe Vanderstraeten	1 Open meeting - geen student	Seniors Femmes	4kg	9,78	9,63	9,79				9,79	10,27
12	Silke Daems	Karel de Grote Hogeschool	Seniors Femmes	4kg	9,23	9,41	8,92				9,41	10,80
13	Sara Vanhalst	Universiteit Gent	Seniors Femmes	4kg	9,03	8,93	8,76				9,03	9,29
14	Helena Oste	Universiteit Gent	Seniors Femmes	4kg	X	X	8,89				8,89	10,28
15	Rune Vierendeels	Hogeschool Gent	Seniors Femmes	4kg	8,66	8,66	8,50				8,66	---
16	Alessia Kairet	HE Louvain en Hainaut	Seniors Femmes	4kg	6,39	6,37	7,01				7,01	7,75
	Laura Van den Brande	Inconnue	Seniors Femmes	4kg	-	-	-				DNS	11,96
	Nina Denolf	Universiteit Gent	Seniors Femmes	4kg	-	-	-				DNS	11,45
	Asgerdur Jana Agustsdottir	1 Open meeting - geen student	Seniors Femmes	4kg	-	-	-				DNS	12,68

Hommes- Triple saut

#	Nom	Club	Catégorie	P 1	P 2	P 3	P 4	P 5	P 6	Résu...	OBP	
1	Gregory Geerts	1 Open meeting - geen student	Seniors Hommes	14,07	14,35	14,17	X	-	X	14,35	-0.7 m/s	14,72
2	Tommy Soumahoro	Université Libre de Bruxelles	Seniors Hommes	13,83	13,89	X	13,69	-	13,98	13,98	-0.3 m/s	14,02
3	Raphaël Ekwalla-Mathieu	Inconnue	Seniors Hommes	X	12,80	12,92	12,88	X	X	12,92	+0.0 m/s	---
4	Thibault Guineberteau	HE Bruxelles - Brabant	Seniors Hommes	12,44	12,67	12,83	12,00	12,55	12,72	12,83	-0.6 m/s	13,07
5	Elias Van Bleyenbergh	1 Open meeting - geen student	Juniors Hommes	12,56	12,61	12,49	12,69	X	X	12,69	-0.8 m/s	12,59
6	Ismaël Diamé	HE Léonard de Vinci	Seniors Hommes	11,53	12,10	X	12,45	12,56	12,57	12,57	+0.0 m/s	12,97
7	Liam Sprangers	Universiteit Gent	Seniors Hommes	X	12,32	X	X	r		12,32	-0.7 m/s	13,02
8	Alexis Van Elsuwé	Université Libre de Bruxelles	Juniors Hommes	X	X	X	11,90	X	11,74	11,90	-0.4 m/s	12,39

Dames- Triple saut

#	Nom	Club	Catégorie	P 1	P 2	P 3	P 4	P 5	P 6	Résu...	OBP	
1	Ilona Masson	HE de la Province de Liège	Seniors Femmes	12,45	X	12,65	X	X	X	12,65	-0.2 m/s	12,91
2	Florence Amon	Erasmus Hogeschool Brussel	Seniors Femmes	11,81	12,12	X	11,60	X	X	12,12	-1.2 m/s	12,07
3	Jolijn Verhaeghe	Katholieke Universiteit Leuven	Seniors Femmes	X	11,19	X	11,11	11,61	X	11,61	-0.8 m/s	11,95
4	Margot Delbare	Universiteit Hasselt	Seniors Femmes	11,29	11,47	X	11,12	11,19	11,28	11,47	+0.5 m/s	11,84
5	Jana Horemans	Universiteit Hasselt	Seniors Femmes	X	11,09	10,97	11,02	11,05	11,02	11,09	-0.1 m/s	11,43
6	Bo Rens	Artesis Plantijn Hogeschool Antwerpen	Seniors Femmes	10,80	10,84	10,95	X	10,93	X	10,95	-0.6 m/s	11,30
7	Amandine Sampson	Université de Liège (site de Liège)	Seniors Femmes	10,51	X	X	10,52	X	10,79	10,79	-0.5 m/s	10,60
8	Maimouna Cisse	Inconnue	Scolaires Femmes	10,14	10,27	10,17	10,41	X	10,33	10,41	-0.5 m/s	10,62
9	An Vannieuwenhuysse	Inconnue	Seniors Femmes	10,23	X	X				10,23	+0.1 m/s	---

Hommes- Saut en hauteur

#	Nom	Club	Catégorie	1,65	1,70	1,75	1,80	1,85	1,90	1,95	2,00	2,05	2,08	2,11	2,14	Rés...	O...
1	Sten Geenens	Universiteit Gent	Seniors Hommes	-	-	-	-	-	O	-	O	O	O	XO	Xr	2,11	2,13
2	Jos Gamuela Ngamunegueta	Université Libre de Bruxelles	Seniors Hommes	-	-	-	-	-	O	O	O	O	X-	XO	XXX	2,11	2,09
3	Lucca Goossens	1 Open meeting - geen student	Scolaires Hommes	-	-	-	-	O	XO	XXX						1,90	1,91
4	Lennert Verduyn	Katholieke Universiteit Leuven	Seniors Hommes	-	-	O	O	O	XXO	XXX						1,90	1,95
4	Médéric Zgajewski	Université Catholique de Louvain	Seniors Hommes	-	O	O	O	O	XXO	XXX						1,90	1,96
6	Chao-Yuan Liu	Katholieke Universiteit Leuven	Seniors Hommes	-	-	-	O	O	XXX							1,85	1,86
7	Romain Stieltjes	1 Open meeting - geen student	Scolaires Hommes	-	O	O	XO	O	XXX							1,85	1,88
8	Lowie Wauters	1 Open meeting - geen student	Scolaires Hommes	O	O	O	XXO	O	XXX							1,85	1,91
9	Jean-Paul Ngongo-Essomba	Université Catholique de Louvain	Seniors Hommes	-	O	O	O	XXO	XXX							1,85	---
10	Ilias Arf	Inconnue	Juniors Hommes	-	O	O	O	XXX								1,80	1,87
11	Pierre Stavart	Katholieke Universiteit Leuven	Juniors Hommes	O	O	XXX										1,70	1,75
12	Melvin LEFEBVRE	HE Louvain en Hainaut	Seniors Hommes	O	XO	XXX										1,70	---
12	Charles TOURTOIS	Université Libre de Bruxelles	Seniors Hommes		XO	XXX										1,70	1,81
	Benjamin Jolis	Université de Liège (site de Liège)	Seniors Hommes	XXX												NM	---

Dames- Saut en hauteur

#	Nom	Club	Catégorie	1,40	1,45	1,50	1,55	1,60	1,65	1,70	1,75	1,78	1,80	Rés...	OBP
1	Yorunn Ligneel	Katholieke Universiteit Leuven	Seniors Femmes	-	-	-	-	-	O	O	XO	XO	XXX	1,78	1,83
2	Lana Clippe	Université Catholique de Louvain	Juniors Femmes	-	-	-	O	O	O	XXX				1,65	1,65
3	Océane Thiebot	Université Libre de Bruxelles	Seniors Femmes	-	-	O	XO	O	O	XXX				1,65	1,65
4	Lise Braux	Université Catholique de Louvain	Seniors Femmes	-	-	O	O	O	XXX					1,60	1,67
5	Lisa Clopterop	Universiteit Gent	Seniors Femmes	-	O	O	XO	XXX						1,55	1,66
6	Alicia De Grave	1 Open meeting - geen student	Cadets Femmes	O	O	XXX								1,45	1,45

Hommes- Saut à la perche

#	Nom	Club	Catégorie	3,61	3,81	4,01	4,21	4,41	4,51	4,61	4,71	4,81	4,91	Rés...	OBP
1	Baptiste Lanotte	Université Catholique de Louvain	Seniors Hommes	-	-	-	-	O	-	XO	O	XO	XXX	4,81	4,85
2	Victor Priem	Universiteit Gent	Juniors Hommes	-	-	-	-	-	XO	-	XXO	XXO	XXX	4,81	4,80
3	Pierre Straet	Université Catholique de Louvain	Seniors Hommes	-	-	-	-	-	O	XO	XO	XXX		4,71	5,20
4	Pierre Stavart	Katholieke Universiteit Leuven	Juniors Hommes	-	-	XO	O	O	XXX					4,41	4,61
5	Loïc Joannes	Université de Liège (site de Liège)	Seniors Hommes	-	-	-	-	XO	-	XXX				4,41	4,90
6	El Hadji Magatte Sene	Inconnue	Seniors Hommes	-	O	O	O	XXO	XXX					4,41	---
7	Thomas Van der Poel	Katholieke Universiteit Leuven	Seniors Hommes	-	-	-	O	XXX						4,21	4,51
8	Maxime Nolf	1 Open meeting - geen student	Seniors Hommes	-	-	XXO	O	XXX						4,21	4,75
9	Guillaume Gobin	HE Charlemagne	Seniors Hommes	-	-	O	XO	XXX						4,21	4,85
10	Clément Lanotte	Ecole Pratiques des Hautes études Commerciales	Seniors Hommes	-	-	O	XXO	XXX						4,21	4,01
11	Florent Hervers	Université de Liège (site de Liège)	Seniors Hommes	O	O	O	XXX							4,01	4,10
12	Ilias Arf	Inconnue	Juniors Hommes	-	XXO	XO	XXX							4,01	4,21
13	Charles TOURTOIS	Université Libre de Bruxelles	Seniors Hommes	O	XXO	XXX								3,81	3,91
14	Simon François	Inconnue	Seniors Hommes	XXO	XXX									3,61	4,12

Dames- Saut à la perche

#	Nom	Club	Catégorie	2,61	2,81	3,01	3,21	3,41	3,61	3,81	3,91	Rés...	OBP
1	Fleur Hooyberghs	Universiteit Gent	Seniors Femmes	-	-	-	-	-	XO	O	XXX	3,81	4,16
2	Dag-Ferene Van Cappellen	Odisee Hogeschool	Seniors Femmes	-	-	-	O	O	XXX			3,41	3,71
3	Hanne Vandenbroucke	Katholieke Universiteit Leuven	Seniors Femmes	-	O	O	XO	XXX				3,21	3,41
4	Caroline Bloch	HE de la Province de Liège	Seniors Femmes	-	-	O	XXX					3,01	3,50
4	Norah De Bruycker	1 Open meeting - geen student	Scolaires Femmes	-	O	O	XXX					3,01	3,37
6	Chloé Van de Sype	1 Open meeting - geen student	Seniors Femmes		O	XXO	XO	XXX				3,01	3,21
7	Mathilde De Meue	Université Catholique de Louvain	Seniors Femmes		O	XXX						2,61	3,22
	Charlotte Vanlangenaker	Katholieke Universiteit Leuven	Juniors Femmes	-	XXX							NM	3,25

Hommes- Saut en longueur

#	Nom	Club	Catégorie	P 1	P 2	P 3	P 4	P 5	P 6	Rés...	OBP	
1	Yannï Sampson	Université de Liège (site de Liège)	Juniors Hommes	X	6,87	6,82	X	7,09	X	7,09	-0.4 m/s	7,19
2	Thomas Van der Poel	Katholieke Universiteit Leuven	Seniors Hommes	6,76	7,01	4,82	6,86	6,95	7,05	7,05	-0.3 m/s	7,29
3	Florent Hervers	Université de Liège (site de Liège)	Seniors Hommes	6,39	6,72	4,30	6,55	6,56	7,01	7,01	-0.7 m/s	6,82
4	Jonas Vander Avert	Artesis Plantijn Hogeschool Antwerpen	Seniors Hommes	6,64	6,75	X	X	X	6,75	6,75	-0.9 m/s	6,99
5	Melvyn Claes	Université Catholique de Louvain	Seniors Hommes	6,17	6,53	6,53	6,75	6,53	6,65	6,75	-0.7 m/s	6,88
6	Arnaud Caluwé	1 Open meeting - geen student	Seniors Hommes	6,70	X	6,74	6,74	X	X	6,74	-0.5 m/s	7,28
7	Simon Dekoninck	Katholieke Universiteit Leuven	Juniors Hommes	6,64	6,44	6,64	X	6,73	X	6,73	-0.8 m/s	6,81
8	Björn De decker	1 Open meeting - geen student	Seniors Hommes	6,44	6,54	X	6,58	X	X	6,58	-0.1 m/s	7,32
9	Rune Wyns	Katholieke Universiteit Leuven	Juniors Hommes	6,03	6,15	6,48				6,48	-0.4 m/s	6,44
10	Thibault Guineberteau	HE Bruxelles - Brabant	Seniors Hommes	6,23	6,42	6,29				6,42	-0.5 m/s	6,49
11	Lucien Iker	Université Catholique de Louvain	Seniors Hommes	6,12	6,18	6,27				6,27	-1.7 m/s	6,40
12	Eduard Goffart Winkin	Katholieke Universiteit Leuven	Seniors Hommes	6,05	5,80	X				6,05	-0.4 m/s	---
13	Lucca Goossens	1 Open meeting - geen student	Scolaires Hommes	X	X	5,97				5,97	-0.4 m/s	6,44
14	Elias Van Bleyenbergh	1 Open meeting - geen student	Juniors Hommes	5,95	X	5,65				5,95	-0.4 m/s	6,47
15	Tim Colignon	Odisee Hogeschool	Seniors Hommes	5,02	5,77	5,93				5,93	-1.0 m/s	6,08
16	Mateo Loforte	HE Libre Mosane	Seniors Hommes	5,52	5,38	4,69				5,52	-0.9 m/s	---
17	Joachim Laus	1 Open meeting - geen student	Masters Hommes	5,42	5,23	5,47				5,47	-1.9 m/s	5,85
18	Nawfel Benouda	HE Léonard de Vinci	Seniors Hommes	5,03	5,37	5,44				5,44	-0.4 m/s	---
19	Elouan LANIER	HE Libre de Bruxelles	Seniors Hommes	5,16	5,07	5,41				5,41	-1.8 m/s	5,58
20	Amaury Meskens	Université Libre de Bruxelles	Seniors Hommes	4,94	5,19	4,71				5,19	-0.8 m/s	---
21	Benjamin Jolis	Université de Liège (site de Liège)	Seniors Hommes	4,39	4,25	5,18				5,18	-1.0 m/s	---
22	Jesse Claus	1 Open meeting - geen student	Cadets Hommes	4,91	4,57	4,79				4,91	-0.5 m/s	5,01
23	Lucas Batlle	Université de Liège (site de Liège)	Seniors Hommes	4,61	4,72	4,88				4,88	-0.1 m/s	---
24	Twan Glorieux	1 Open meeting - geen student	Cadets Hommes	4,56	4,04	3,70				4,56	+0.0 m/s	4,75
25	Siméon Collart	Inconnue	Cadets Hommes	3,84	4,05	3,89				4,05	+0.1 m/s	4,21

Dames- Saut en longueur

#	Nom	Club	Catégorie	P 1	P 2	P 3	P 4	P 5	P 6	Ré...	OBP	
1	Maité Beernaert	Katholieke Universiteit Leuven	Seniors Femmes	5,71	X	5,69	5,90	5,99	X	5,99	-0.9 m/s	6,01
2	Ilona Masson	HE de la Province de Liège	Seniors Femmes	X	5,85	X	X	X	X	5,85	-0.4 m/s	6,12
3	Laura Ooghe	1 Open meeting - geen student	Scolaires Femmes	5,83	5,82	X	5,84	X	5,69	5,84	-0.4 m/s	6,13
4	Jolijn Verhaeghe	Katholieke Universiteit Leuven	Seniors Femmes	X	5,05	5,24	5,42	5,62	5,43	5,62	-0.6 m/s	5,88
5	Sara Van Hoyweghen	Universiteit Gent	Seniors Femmes	5,58	4,99	5,21	r			5,58	+0.4 m/s	5,69
6	May Lee Cooper	Université de Liège (site de Gembloux)	Seniors Femmes	5,47	5,48	5,30	X	5,27	5,54	5,54	-0.4 m/s	5,77
7	Anne-Dominique Baramoto	Vrije Universiteit Brussel	Seniors Femmes	X	5,14	5,20	5,34	5,23	5,50	5,50	-1.4 m/s	5,98
8	Soraya De Sousa Moreira	Université Libre de Bruxelles	Seniors Femmes	5,34	5,45	5,43	5,20	X	X	5,45	-1.8 m/s	---
9	Prisca Kizito	Odisee Hogeschool	Seniors Femmes	4,95	5,06	5,10				5,10	-0.2 m/s	5,58
10	Febe Ameys	Universiteit Gent	Seniors Femmes	3,71	4,93	5,05				5,05	+0.2 m/s	5,42
11	Sara Vanhalst	Universiteit Gent	Seniors Femmes	4,80	4,98	4,95				4,98	-0.2 m/s	5,45
12	Emeline Cleymans	Université Catholique de Louvain	Seniors Femmes	4,79	4,96	4,86				4,96	-0.3 m/s	5,51
13	Jade Cowie	Inconnue	Juniors Femmes	4,71	4,78	4,69				4,78	-0.4 m/s	4,97
14	Lene Barbé	Universiteit Gent	Juniors Femmes	4,67	4,68	4,52				4,68	-0.7 m/s	4,97
15	Elise Poot	Université Catholique de Louvain	Seniors Femmes	X	4,35	4,65				4,65	+0.1 m/s	5,25
16	Sephora Kana	Ecole Pratiques des Hautes études Commerciales	Seniors Femmes	3,93	3,98	3,71				3,98	+0.1 m/s	---
17	Luna Van De Wiele	Inconnue	Scolaires Femmes	2,78	X	3,68				3,68	-0.8 m/s	4,69
18	Rachel Henno	HE Louvain en Hainaut	Seniors Femmes	3,47	X	X				3,47	-0.2 m/s	---
	Eve Willems	Universiteit Gent	Seniors Femmes	X	X	X				NM		5,54

Hommes – Javelot

#	Nom	Club	Catégorie	Poids	P 1	P 2	P 3	P 4	P 5	P 6	Résul...	OBP
1	Cedric Sorgeloos	Universiteit Gent	Seniors Hommes	800gr	66,71	67,33	62,72	64,41	63,68	62,45	67,33	72,92
2	Victor Suy	Universiteit Gent	Juniors Hommes	800gr	49,67	50,21	47,09	52,22	51,68	46,64	52,22	54,46
3	Lukas Deroo	Universiteit Gent	Seniors Hommes	800gr	49,97	50,33	48,88	44,85	48,88	46,25	50,33	51,63
4	Sven Vereecken	Universiteit Gent	Seniors Hommes	800gr	37,96	38,93	39,65	39,32	40,36	43,70	43,70	---
5	Melvin LEFEBVRE	HE Louvain en Hainaut	Seniors Hommes	800gr	X	32,94	32,85	31,40	37,82	X	37,82	---
6	Ismaël Diamé	HE Léonard de Vinci	Seniors Hommes	800gr	34,50	34,88	36,16	r			36,16	41,01
7	Robin Van Poucke	1 Open meeting - geen student	Masters Hommes	800gr	31,00	35,57	X	31,48	34,78	30,82	35,57	32,64

Dames – Javelot

#	Nom	Club	Catégorie	Poids	P 1	P 2	P 3	P 4	P 5	P 6	Résu...	OBP
1	Cassandre Evans	HE de la Province de Liège	Seniors Femmes	600gr	35,35	36,96	35,24	37,52	36,18	40,20	40,20	45,84
2	Kayla Iven	HE Léonard de Vinci	Seniors Femmes	600gr	39,61	X	37,50	39,96	39,97	39,24	39,97	45,14
3	Fleur Verstraete	Universiteit Gent	Seniors Femmes	600gr	37,59	39,32	39,59	39,48	37,53	38,93	39,59	43,71
4	Caroline Vanhamme	Université Catholique de Louvain	Seniors Femmes	600gr	35,93	38,15	X	36,35	32,52	35,66	38,15	39,78
5	Annelien Beelaert	Universiteit Gent	Seniors Femmes	600gr	34,29	35,53	35,35	34,56	36,69	35,55	36,69	38,84
6	Linde Breban	Universiteit Hasselt	Juniors Femmes	600gr	34,80	35,41	34,07	33,83	35,95	35,74	35,95	38,46
7	Britt Rens	Karel de Grote Hogeschool	Seniors Femmes	600gr	31,64	34,17	X	X	X	33,42	34,17	38,71
8	Lotte Huvenne	Inconnue	Seniors Femmes	600gr	30,54	30,58	31,25	29,37	X	28,60	31,25	36,56
9	Bo Rens	Artesis Plantijn Hogeschool Antwerpen	Seniors Femmes	600gr	X	28,73	X				28,73	29,62
10	Violette Ackaert	Université de Liège (site de Liège)	Seniors Femmes	600gr	23,11	24,28	26,98				26,98	31,15
11	Maëva Defosse	Université de Mons	Seniors Femmes	600gr	26,30	24,47	23,89				26,30	27,70
12	Rune Vierendeels	Hogeschool Gent	Seniors Femmes	600gr	20,54	21,11	20,69				21,11	---
13	Rachel Henno	HE Louvain en Hainaut	Seniors Femmes	600gr	16,05	X	9,90				16,05	---
14	Alessia Kairet	HE Louvain en Hainaut	Seniors Femmes	600gr	X	15,08	13,63				15,08	18,44

Hommes – Disque

#	Nom	Club	Catégorie	P...	P 1	P 2	P 3	P 4	P 5	P 6	Résu...	OBP
1	Andreas De Lathauwer	Odisee Hogeschool	Seniors Hommes	2kg	46,34	48,73	50,70	47,49	48,29	X	50,70	54,31
2	Leander Casteels	Hogeschool Gent	Seniors Hommes	2kg	46,17	46,51	49,00	48,32	47,92	47,66	49,00	48,32
3	Wietse Vander Schelde	Katholieke Universiteit Leuven	Seniors Hommes	2kg	38,99	39,50	42,60	41,79	44,14	X	44,14	41,49
4	Arnaud De Cremer	Universiteit Gent	Seniors Hommes	2kg	42,55	42,43	44,00	X	X	X	44,00	43,57
5	Stan Van wassenhove	Katholieke Universiteit Leuven	Seniors Hommes	2kg	36,07	X	36,88	X	36,55	37,90	37,90	36,33
6	Dylan Volckaert	Universiteit Gent	Seniors Hommes	2kg	X	35,47	36,43	X	35,18	X	36,43	37,10
7	Médéric Zgajewski	Université Catholique de Louvain	Seniors Hommes	2kg	32,31	X	28,77	29,43	33,23	32,33	33,23	32,44
8	Joris Willems	1 Open meeting - geen student	Juniors Hommes	2kg	29,68	33,16	29,67	X	32,87	32,37	33,16	32,22
9	Jelle Daems	Artesis Plantijn Hogeschool Antwerpen	Juniors Hommes	2kg	23,53	31,16	31,91				31,91	27,76
10	Dries Van de Vyver	Inconnue	Seniors Hommes	2kg	28,39	30,46	X				30,46	29,16
11	Riyaad El Amrani	Artesis Plantijn Hogeschool Antwerpen	Seniors Hommes	2kg	20,80	23,22	20,90				23,22	21,22
12	Robin Van Poucke	1 Open meeting - geen student	Masters Hommes	2kg	20,30	20,03	21,96				21,96	21,10
13	François De Radiguès	Université Catholique de Louvain	Seniors Hommes	2kg	19,71	20,64	X				20,64	---
	Victor Gossard	Université Catholique de Louvain	Seniors Hommes	2kg	X	X	X				NM	31,66
	Guillaume De Roover	1 Open meeting - geen student	Seniors Hommes	2kg	X	X	X				NM	39,71
	Tom Vanmarsenille	Hogeschool Gent	Seniors Hommes	2kg	-	-	-				DNS	36,20
	Arnout Schokkaert	Universiteit Gent	Seniors Hommes	2kg	-	-	-				DNS	28,43

Dames – Disque

#	Nom	Club	Catégorie	P...	P 1	P 2	P 3	P 4	P 5	P 6	Résu...	OBP
1	Sena Tay	Inconnue	Juniors Femmes	1kg	45,91	X	X	X	45,55	48,48	48,48	47,51
2	Florence Boeynaems	Artesis Plantijn Hogeschool Antwerpen	Seniors Femmes	1kg	X	41,57	38,51	47,67	48,25	47,52	48,25	46,26
3	Annelien Beelaert	Universiteit Gent	Seniors Femmes	1kg	39,61	39,43	39,09	39,39	40,14	39,97	40,14	41,83
4	Tyra Steur	Universiteit Gent	Seniors Femmes	1kg	37,38	38,24	X	38,43	X	X	38,43	40,85
5	Silke De Lathauwer	1 Open meeting - geen student	Scolaires Femmes	1kg	X	29,92	35,85	33,75	X	X	35,85	37,63
6	Phebe Vanderstraeten	1 Open meeting - geen student	Seniors Femmes	1kg	32,99	32,46	31,94	X	30,05	33,32	33,32	33,81
7	Eva Vanwesemael	Thomas More	Seniors Femmes	1kg	X	X	31,51	32,35	X	X	32,35	33,78
8	Inge Eeckhout	1 Open meeting - geen student	Scolaires Femmes	1kg	31,39	28,06	X	28,93	31,08	25,79	31,39	30,37
9	Helena Oste	Universiteit Gent	Seniors Femmes	1kg	29,94	30,27	29,88				30,27	34,65
10	Jolien Verstraeten	Arteveldehogeschool	Seniors Femmes	1kg	29,11	29,99	28,85				29,99	34,14
11	Lien Swinnen	1 Open meeting - geen student	Cadets Femmes	1kg	29,93	29,47	X				29,93	35,54
12	Elke De Vleeschauwer	1 Open meeting - geen student	Seniors Femmes	1kg	27,89	28,75	X				28,75	33,37
13	Maartje De Temmerman	1 Open meeting - geen student	Scolaires Femmes	1kg	X	X	26,21				26,21	30,89
14	Marion Philippart	Inconnue	Juniors Femmes	1kg	20,52	23,36	X				23,36	---
15	Alessia Kairet	HE Louvain en Hainaut	Seniors Femmes	1kg	22,01	22,86	22,49				22,86	23,05
16	Camille Chauvin	HE Provinciale du Hainaut-Condorcet	Seniors Femmes	1kg	22,53	20,16	20,04				22,53	22,43
17	Thais Flamand	1 Open meeting - geen student	Scolaires Femmes	1kg	22,45	19,58	22,34				22,45	22,77
18	Sarah Eeckhout	Universiteit Gent	Seniors Femmes	1kg	19,96	19,85	X				19,96	20,85

Résultats du Championnat FSUB d'Athlétisme outdoor

Oordegem

Lundi 1 mai 2023



Résultats du Championnat d'Athlétisme outdoor FSUB

Lundi 1 mai 2023

Participants par sexe, 609 au total

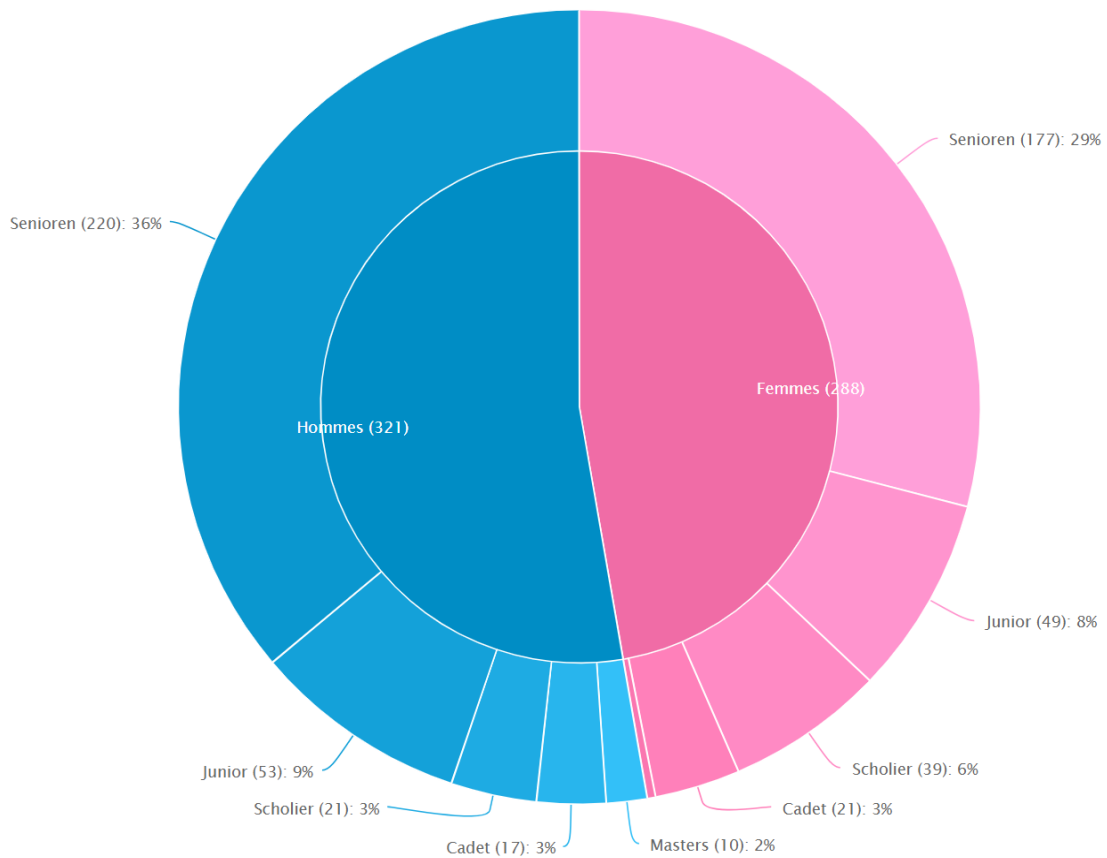

Participants par club, 609 au total

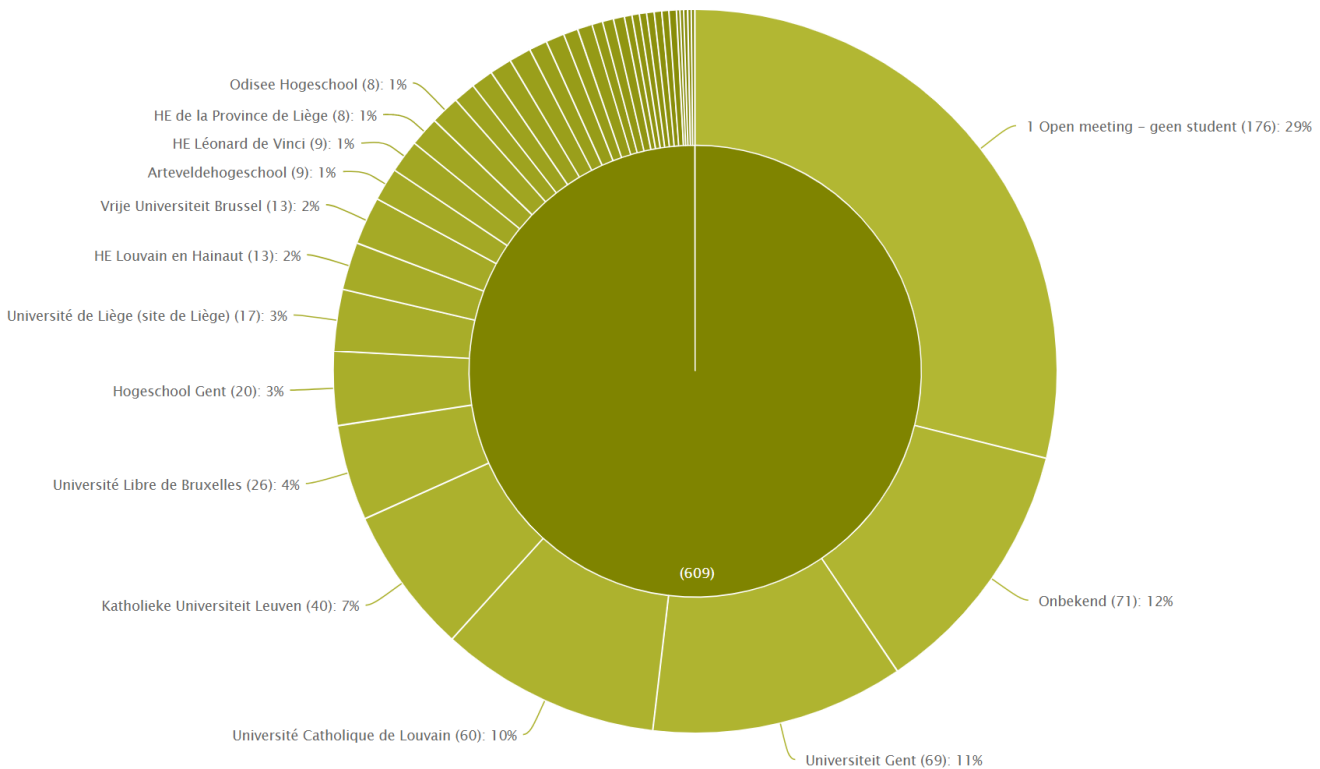

Hommes- 110m Haies

#	Nom	Club	Catégorie	Hauteur des ha...	Résultat		OBP
1	Nolan Vancauwemberghe	Université Catholique de Louvain	Seniors Hommes	106.7cm	14,02	-0.5 m/s	13,83
2	Jente Hautkeete	Arteveldehogeschool	Seniors Hommes	106.7cm	14,46	-0.5 m/s	14,50
3	Jannes Boonen	Inconnue	Seniors Hommes	106.7cm	14,70	-0.5 m/s	14,84
4	Robin Goossens	1 Open meeting - geen student	Seniors Hommes	106.7cm	14,83	-0.5 m/s	14,81
5	Senne Segers	Thomas More	Seniors Hommes	106.7cm	14,85	-0.5 m/s	14,26
6	Ewout Dumon	Inconnue	Seniors Hommes	106.7cm	14,99	-0.5 m/s	14,48
7	Maxime Debacker	HE Louvain en Hainaut	Seniors Hommes	106.7cm	15,33	-0.9 m/s	15,46
8	Wout Van Hoof	Universiteit Gent	Juniors Hommes	106.7cm	15,76	-0.9 m/s	16,22
9	Arnout Schokkaert	Universiteit Gent	Seniors Hommes	106.7cm	16,39	-0.9 m/s	16,42
10	Tom Vanmarsenille	Hogeschool Gent	Seniors Hommes	106.7cm	16,66	-0.9 m/s	17,10
11	Niels Laevens	Inconnue	Seniors Hommes	106.7cm	16,93	-0.9 m/s	16,45
12	Eduard Goffart Winkin	Katholieke Universiteit Leuven	Seniors Hommes	106.7cm	21,54	-0.9 m/s	---
	Hadrien Riga	HE de la Province de Liège	Seniors Hommes	106.7cm	DNF		15,28

Dames- 100m Haies

#	Nom	Club	Catégorie	Hauteur des ha...	Résultat		OBP
1	Angel Agwazie	Odisee Hogeschool	Seniors Femmes	83.8cm	13,66	-0.5 m/s	13,63
2	Lynn Beck	Katholieke Universiteit Leuven	Seniors Femmes	83.8cm	13,87	-0.5 m/s	13,70
3	Noor Koekelkoren	1 Open meeting - geen student	Juniors Femmes	83.8cm	14,25	-0.5 m/s	14,62
4	Zita Goossens	Universiteit Gent	Seniors Femmes	83.8cm	14,42	-0.5 m/s	14,41
5	Laures Bauwens	Universiteit Gent	Seniors Femmes	83.8cm	14,44	-0.9 m/s	---
6	Sara Roggeman	Universiteit Gent	Juniors Femmes	83.8cm	14,46	-0.5 m/s	14,40
7	Laura Van den Brande	Inconnue	Seniors Femmes	83.8cm	14,47	-0.5 m/s	14,32
8	Nina Denolf	Universiteit Gent	Seniors Femmes	83.8cm	14,83	-0.5 m/s	14,48
9	Emeline Cleymans	Université Catholique de Louvain	Seniors Femmes	83.8cm	15,18	-0.8 m/s	15,20
10	Lotte Philips	Katholieke Universiteit Leuven	Seniors Femmes	83.8cm	15,24	-0.8 m/s	14,98
11	Gretel Canters	Hogeschool PXL	Seniors Femmes	83.8cm	15,34	-0.8 m/s	15,29
12	Lolke Vierendeels	Universiteit Gent	Seniors Femmes	83.8cm	15,61	-0.8 m/s	16,40
13	Steffi De Saegher	Inconnue	Juniors Femmes	83.8cm	15,77	-0.9 m/s	19,59
14	Asgerdur Jana Agustsdottir	1 Open meeting - geen student	Seniors Femmes	83.8cm	15,86	-0.9 m/s	---
15	Caroline Bloch	HE de la Province de Liège	Seniors Femmes	83.8cm	16,31	-0.8 m/s	15,80
16	Antje De Schryver	1 Open meeting - geen student	Juniors Femmes	83.8cm	17,27	-0.9 m/s	---
17	Violette Ackaert	Université de Liège (site de Liège)	Seniors Femmes	83.8cm	18,76	-0.9 m/s	16,42
	Aurore Duchêne	Université Libre de Bruxelles	Seniors Femmes	83.8cm	DNF		---

Hommes- 3000m steeple

#	Nom	Club	Catégorie	Hauteur des ha...	Résultat		OBP
1	Lucas Lievens	Arteveldehogeschool	Seniors Hommes	91.4cm	9:39,68		9:17,72
2	Maxime Coiffé	Université Libre de Bruxelles	Seniors Hommes	91.4cm	10:27,55		---
3	Jonas Wuyts	Universiteit Antwerpen	Seniors Hommes	91.4cm	11:01,47		---
4	Tim Vandevelde	Hogeschool West-Vlaanderen	Seniors Hommes	91.4cm	11:15,24		11:01,00

Dames- 3000m steeple

#	Nom	Club	Catégorie	Hauteur des ha...	Résultat		OBP
1	Jana Spiessens	Artis Plantijn Hogeschool Antwerpen	Seniors Femmes	76.2cm	13:19,89		12:49,77
2	Tina De Leye	1 Open meeting - geen student	Seniors Femmes	76.2cm	13:27,30		---

Hommes – 5000m

#	Nom	Club	Catégorie	Résultat	OBP
1	Sébastien Fauconnier	Université Catholique de Louvain	Seniors Hommes	14:24,58	14:48,04
2	Thomas Monfils	Inconnue	Seniors Hommes	14:49,61	---
3	Thomas Van der Kaa	Université Catholique de Louvain	Seniors Hommes	15:07,79	---
4	Donald Lalmand	HE Libre de Bruxelles	Seniors Hommes	15:41,79	---
5	Artem Onyshchenko	1 Open meeting - geen student	Juniors Hommes	15:47,55	15:26,99
6	Pierre Houssiere	Université Catholique de Louvain	Seniors Hommes	15:51,30	16:27,21
7	Ghislain Deswaef	HE Léonard de Vinci	Seniors Hommes	16:04,44	16:36,67
8	Benjamin De Greef	HE Léonard de Vinci	Seniors Hommes	16:27,28	---
9	Antoine Lechat	Université Catholique de Louvain	Seniors Hommes	16:33,45	---
10	Guillaume Robert	Inconnue	Seniors Hommes	16:49,33	---
11	Ruben Vercooter	Inconnue	Seniors Hommes	17:12,58	17:21,88
12	Simon Dendas	HE de Namur Liège Luxembourg	Seniors Hommes	17:33,76	---
13	Marlen Azhigallyev	Université Catholique de Louvain	Seniors Hommes	18:42,32	---
	DORIAN TORDEUR	Université Catholique de Louvain	Seniors Hommes	DNF	---
	Pierre Vancolen	Université Catholique de Louvain	Seniors Hommes	DNF	15:21,31

Dames- 5000m

#	Nom	Club	Catégorie	Résultat	OBP
1	Valerie Rooms	1 Open meeting - geen student	Seniors Femmes	17:43,60	---
2	Elisa Vancoelen	Université Catholique de Louvain	Seniors Femmes	17:46,61	18:11,14
3	Bridey Waerzeggers	Vrije Universiteit Brussel	Seniors Femmes	19:16,27	18:25,68
4	Lynn Hübinger	Université Catholique de Louvain	Juniors Femmes	19:56,00	---
5	Bianca Hermans	Thomas More	Seniors Femmes	20:35,99	---
6	Anneleen Vancoppenolle	Katholieke Universiteit Leuven	Seniors Femmes	21:52,17	---
7	Elise Lechat	Université de Liège (site de Liège)	Seniors Femmes	21:54,57	---

Hommes- 1500m

#	Nom	Club	Catégorie	Résultat	OBP
1	Andy Keymolen	Vrije Universiteit Brussel	Seniors Hommes	4:00,42	3:57,72
2	Thibault Lelièvre	Université Catholique de Louvain	Seniors Hommes	4:01,37	4:02,62
3	Amir Sidali	Erasmus Hogeschool Brussel	Seniors Hommes	4:02,43	4:09,59
4	Nicolas Bouriez	Université Catholique de Louvain	Seniors Hommes	4:05,46	4:11,00
5	Achille Lelion	Inconnue	Juniors Hommes	4:05,81	4:11,08
6	Antoine Berti	Inconnue	Seniors Hommes	4:06,00	4:03,00
7	Louis Duyckaerts	Vrije Universiteit Brussel	Seniors Hommes	4:07,13	4:03,06
8	Loïc Delvaux	HE Charlemagne	Seniors Hommes	4:07,70	4:06,63
9	Renu De Samblancx	1 Open meeting - geen student	Cadets Hommes	4:08,02	4:17,36
10	Dylan Champenois	Inconnue	Seniors Hommes	4:10,68	4:06,50
11	Ruben Redant	Arteveldehogeschool	Seniors Hommes	4:11,22	4:12,30
12	Antoine Lengele	Université de Mons	Seniors Hommes	4:11,36	4:08,21
13	Kilani Njema	Inconnue	Cadets Hommes	4:14,28	4:07,49
14	Tristan Blommaert	Thomas More	Seniors Hommes	4:21,40	4:15,45
15	Henri Smeers	Université Catholique de Louvain	Juniors Hommes	4:22,65	4:24,75
16	Pieter Van Hoecke	Universiteit Gent	Seniors Hommes	4:23,03	4:24,88
17	Ilyas Sakouane Zaghdoud	1 Open meeting - geen student	Scolaires Hommes	4:24,27	4:35,83
18	Matthias Meert	1 Open meeting - geen student	Cadets Hommes	4:28,83	4:38,65
19	Michiel Van Durpe	Odisee Hogeschool	Seniors Hommes	4:29,44	4:28,95
20	Liam Heirman	1 Open meeting - geen student	Scolaires Hommes	4:38,00	4:55,37
21	François Clinquart	Université Catholique de Louvain	Juniors Hommes	4:39,69	---
22	Mateo Longo-Murit	1 Open meeting - geen student	Cadets Hommes	4:42,36	---
23	Kobe Dhont	Inconnue	Seniors Hommes	4:44,67	4:53,45
24	Léo Renaldi	1 Open meeting - geen student	Cadets Hommes	4:51,23	---
25	Odinn Van Damme	1 Open meeting - geen student	Cadets Hommes	5:07,81	4:53,78

Dames- 1500m

#	Nom	Club	Catégorie	Résultat	OBP
1	Emma Dubie	HE Louvain en Hainaut	Seniors Femmes	4:49,80	4:37,66
2	Eloïse LEFEVRE	Université de Liège (site de Liège)	Juniors Femmes	4:51,01	4:53,60
3	Soraya Meert	Inconnue	Seniors Femmes	4:54,01	4:37,07
4	Maximilienne Lombard	Université Libre de Bruxelles	Seniors Femmes	4:54,49	4:55,61
5	Marie Mazzoli	Université Catholique de Louvain	Seniors Femmes	5:03,56	4:51,39
6	Ambre Cogez	1 Open meeting - geen student	Scolaires Femmes	5:13,43	5:15,00
7	Iseult Salliez	1 Open meeting - geen student	Scolaires Femmes	5:18,04	5:17,82
8	Nina Richir Deville	1 Open meeting - geen student	Cadets Femmes	5:20,29	5:22,98
9	Ayco Van Raemdonck	1 Open meeting - geen student	Scolaires Femmes	5:22,45	5:21,43
10	Ine Laridon	Inconnue	Seniors Femmes	5:25,64	---
11	Joke Steurbaut	Universiteit Gent	Seniors Femmes	5:31,03	5:29,24
12	Lisa Marchant	Université Libre de Bruxelles	Seniors Femmes	5:31,87	---
13	Zehra Berlangier	1 Open meeting - geen student	Scolaires Femmes	5:37,77	5:39,68

Hommes- 100m

#	Nom	Club	Catégorie	Résultat		OBP
1	Adrien Devriendt	Inconnue	Seniors Hommes	10,76	+1.7 m/s	10,80
2	Antoine Snyders	HE Libre Mosane	Seniors Hommes	10,76	+1.7 m/s	10,54
3	Cédric Motieh	1 Open meeting - geen student	Juniors Hommes	10,89	+1.7 m/s	10,73
4	Geoffrey Jacques	HE Libre Mosane	Seniors Hommes	10,89	+1.7 m/s	10,84
5	Ibrahim Camara	1 Open meeting - geen student	Juniors Hommes	10,90	+1.7 m/s	10,83
6	Marnix De Pauw	Odisee Hogeschool	Juniors Hommes	10,95	+1.7 m/s	10,80
7	Camille Snyders	HE de la Province de Liège	Seniors Hommes	11,03	-1.1 m/s	10,92
8	Clément Brunin	1 Open meeting - geen student	Seniors Hommes	11,05	+1.7 m/s	10,81
9	Nolan Vancauwemberghe	Université Catholique de Louvain	Seniors Hommes	11,06	-1.1 m/s	11,00
10	Thomas Van Ingelgem	1 Open meeting - geen student	Masters Hommes	11,10	-0.1 m/s	11,10
11	Floran Dehout	HE Louvain en Hainaut	Seniors Hommes	11,11	-0.1 m/s	11,16
12	Florian Tshitwenu	Ecole Pratiques des Hautes études Commerciales	Seniors Hommes	11,13	+1.7 m/s	10,66
13	Guélord Kola biasu	1 Open meeting - geen student	Seniors Hommes	11,13	-1.1 m/s	10,97
14	Meindert Caudron	Inconnue	Juniors Hommes	11,17	-0.1 m/s	11,08
15	Xavier Rousseau	1 Open meeting - geen student	Scolaires Hommes	11,17	-0.1 m/s	11,05
16	Bjirsen Deherder	1 Open meeting - geen student	Seniors Hommes	11,19	-0.1 m/s	11,27
17	Hadrien Wimlot	Université Libre de Bruxelles	Seniors Hommes	11,19	-0.1 m/s	11,11
18	Enguerran Bossicard	HE Louvain en Hainaut	Seniors Hommes	11,20	-1.1 m/s	10,87
19	Gautier Brichet	HE Léonard de Vinci	Seniors Hommes	11,22	-0.1 m/s	11,23
20	Jitse Mievis	Erasmus Hogeschool Brussel	Seniors Hommes	11,22	-1.1 m/s	10,85
21	Simon Dekoninck	Katholieke Universiteit Leuven	Juniors Hommes	11,24	-0.1 m/s	11,25
22	Stijn Van der Vreken	Hogeschool Gent	Juniors Hommes	11,26	-1.1 m/s	10,89
23	Siemen Masure	Universiteit Gent	Seniors Hommes	11,27	-1.1 m/s	10,94
24	Charles Hamaide	1 Open meeting - geen student	Seniors Hommes	11,28	-0.1 m/s	11,19
25	Tibe Temmerman	Inconnue	Juniors Hommes	11,28	-0.1 m/s	11,03
26	Maxime Debacker	HE Louvain en Hainaut	Seniors Hommes	11,32	-0.1 m/s	11,12
27	Quentin Hoffken	1 Open meeting - geen student	Juniors Hommes	11,33	-0.7 m/s	11,39
28	Marko Medan	Université Libre de Bruxelles	Seniors Hommes	11,34	-1.1 m/s	10,95
29	Nicolas Léonard	HE Léonard de Vinci	Seniors Hommes	11,39	-0.1 m/s	11,16
30	Dorian André	1 Open meeting - geen student	Seniors Hommes	11,40	-0.2 m/s	11,62
31	Yannil Sampson	Université de Liège (site de Liège)	Juniors Hommes	11,41	-0.7 m/s	11,42
32	Jean-Charles Nsangolo	1 Open meeting - geen student	Seniors Hommes	11,43	-0.7 m/s	11,35
33	Reginald Beele	Inconnue	Seniors Hommes	11,44	-0.1 m/s	11,26
34	Senne Segers	Thomas More	Seniors Hommes	11,49	-0.1 m/s	11,15
34	Gertjan Demeur	1 Open meeting - geen student	Seniors Hommes	11,49	-0.7 m/s	11,40
36	Simon Cotton	HE Louvain en Hainaut	Seniors Hommes	11,49	-0.1 m/s	11,12
37	Mateo Loforte	HE Libre Mosane	Seniors Hommes	11,58	-0.7 m/s	11,44
38	Jasper Vermaelen	1 Open meeting - geen student	Juniors Hommes	11,61	-0.2 m/s	11,56
39	Alexander Van Vliet	Universiteit Gent	Juniors Hommes	11,62	+1.1 m/s	11,90
40	Storm Tuyls	Hogeschool Gent	Seniors Hommes	11,64	-0.1 m/s	11,25
41	Cedric Oum Oyono	HE en Hainaut	Seniors Hommes	11,69	-0.7 m/s	—
42	Titouan Danno	Université Libre de Bruxelles	Seniors Hommes	11,70	+1.1 m/s	11,86
43	Jarne Mariën	Universiteit Antwerpen	Juniors Hommes	11,71	-0.2 m/s	11,67
44	Jason Schollaert	Katholieke Universiteit Leuven	Seniors Hommes	11,72	+1.1 m/s	12,02
45	Melvyn Claes	Université Catholique de Louvain	Seniors Hommes	11,75	-0.2 m/s	11,74
46	Briek Ryckaert	1 Open meeting - geen student	Juniors Hommes	11,75	-0.2 m/s	11,75
47	Ludovic Fenaux	1 Open meeting - geen student	Masters Hommes	11,79	-0.7 m/s	11,33
48	Zaaquib Yunus Ahmed	1 Open meeting - geen student	Seniors Hommes	11,83	-0.7 m/s	11,51
49	Robbe Van Hoorde	1 Open meeting - geen student	Scolaires Hommes	11,85	-0.7 m/s	—
50	Noé Koch	Université Catholique de Louvain	Seniors Hommes	11,90	-0.2 m/s	11,77
51	Mathys Van Hove	1 Open meeting - geen student	Juniors Hommes	11,93	-0.7 m/s	11,39
52	Victor De Spiegeleire	1 Open meeting - geen student	Scolaires Hommes	11,96	-0.3 m/s	12,27
53	Melchizedek Agyemang	Hogeschool Gent	Seniors Hommes	11,98	-0.2 m/s	11,76





53	Victor Suy	Universiteit Gent	Juniors Hommes	11,98	+1.1 m/s	11,90
55	Gaëtan Van Buynder	Hogeschool Gent	Juniors Hommes	12,02	-0.3 m/s	---
56	Stef Wageman	1 Open meeting - geen student	Scolaires Hommes	12,03	-0.3 m/s	12,21
57	Ethan Sébastien Dumont	HE Provinciale du Hainaut-Condorcet	Seniors Hommes	12,11	-0.3 m/s	12,87
58	Wouter Vander Mijnsbrugge	1 Open meeting - geen student	Seniors Hommes	12,14	+1.1 m/s	12,10
59	Amaury Meskens	Université Libre de Bruxelles	Seniors Hommes	12,18	-0.7 m/s	---
60	Tristan Bistrussu	1 Open meeting - geen student	Juniors Hommes	12,19	-0.3 m/s	12,84
61	Ali Lachkar	Université Libre de Bruxelles	Seniors Hommes	12,25	-0.2 m/s	11,73
62	Michiel Hagen	Katholieke Universiteit Leuven	Seniors Hommes	12,34	-0.3 m/s	12,16
63	Elouan LANIER	HE Libre de Bruxelles	Seniors Hommes	12,34	-0.3 m/s	---
64	Joachim Laus	1 Open meeting - geen student	Masters Hommes	12,37	-0.3 m/s	12,21
65	Jakob Verleyen	1 Open meeting - geen student	Cadets Hommes	12,39	0.3 m/s	12,64
66	Matisse Barbio	1 Open meeting - geen student	Juniors Hommes	12,40	+1.1 m/s	12,15
67	Joppe Gutschoven	1 Open meeting - geen student	Scolaires Hommes	12,67	-0.3 m/s	12,91
68	Jesse Claus	1 Open meeting - geen student	Cadets Hommes	12,71	-0.3 m/s	13,29
69	Lucas Batlle	Université de Liège (site de Liège)	Seniors Hommes	12,91	-0.7 m/s	---
70	Pascal Rijdant	1 Open meeting - geen student	Masters Hommes	13,01	-0.3 m/s	12,73
71	MAXIME Piedboeuf	HE de la Province de Liège	Juniors Hommes	13,24	-0.7 m/s	---
72	Aurélien Belle	HE Louvain en Hainaut	Seniors Hommes	13,66	-0.3 m/s	---
73	Michaël De Prins	Karel de Grote Hogeschool	Seniors Hommes	13,75	-0.3 m/s	13,47
74	Tim De Reuse	1 Open meeting - geen student	Masters Hommes	14,15	-0.7 m/s	---
75	Siméon Collart	Inconnue	Cadets Hommes	14,46	-0.7 m/s	---
	Liam Sprangers	Universiteit Gent	Seniors Hommes	DNS		11,93

Dames- 100m





























#	Nom	Club	Catégorie	Résultat		OBP
1	Rani Vincke	Universiteit Gent	Seniors Femmes	11,72	-0.1 m/s	11,53
2	Lotte Van Lent	Katholieke Universiteit Leuven	Seniors Femmes	11,83	-0.1 m/s	11,79
3	Callie Lizzie Nzukou Wakam	Université Libre de Bruxelles	Seniors Femmes	11,84	-0.2 m/s	12,09
4	Janie De Naeyer	Universiteit Antwerpen	Seniors Femmes	11,86	-0.1 m/s	11,71
5	Nora Thiry	HE de la Province de Liège	Seniors Femmes	11,99	-0.1 m/s	11,71
6	Angel Agwazie	Odisee Hogeschool	Seniors Femmes	12,15	-0.2 m/s	12,05
7	Anouchka Kadiamba	Hogeschool Gent	Seniors Femmes	12,20	-0.2 m/s	12,02
8	Cloe CHAVEPEYER	HE Louvain en Hainaut	Seniors Femmes	12,20	-0.1 m/s	11,72
9	Camille Sonnevile	1 Open meeting - geen student	Scolaires Femmes	12,21	-0.2 m/s	12,16
10	Tinne Vertongen	1 Open meeting - geen student	Juniors Femmes	12,24	-0.1 m/s	11,89
11	Alizee Morency Poilvache	Université Libre de Bruxelles	Seniors Femmes	12,25	-0.1 m/s	11,71
12	Lynn Beck	Katholieke Universiteit Leuven	Seniors Femmes	12,26	-0.2 m/s	12,26
13	Evy Seghers	Vrije Universiteit Brussel	Seniors Femmes	12,28	-0.2 m/s	12,23
14	Sarah-Daisy Tshiamala-Bitota	HE Louvain en Hainaut	Seniors Femmes	12,34	-0.1 m/s	11,91
15	Noor Vermeiren	1 Open meeting - geen student	Juniors Femmes	12,45	-2.1 m/s	12,32
16	Libelia Vincke	Hogeschool West-Vlaanderen	Seniors Femmes	12,55	-0.2 m/s	12,01
17	Aurore Duchêne	Université Libre de Bruxelles	Seniors Femmes	12,56	-2.1 m/s	12,54
18	Zoë Willemyns	1 Open meeting - geen student	Scolaires Femmes	12,66	-0.6 m/s	12,64
19	Kyra Janssens	Vrije Universiteit Brussel	Seniors Femmes	12,66	-0.2 m/s	12,28
20	Sterre Provost	1 Open meeting - geen student	Scolaires Femmes	12,70	-2.1 m/s	12,32
21	Nona Heyvaert	1 Open meeting - geen student	Juniors Femmes	12,72	-0.6 m/s	12,65
22	Chloe Philippe	1 Open meeting - geen student	Scolaires Femmes	12,74	-2.1 m/s	12,47
23	Dora De Haseleer	Université Catholique de Louvain	Seniors Femmes	12,80	-2.1 m/s	12,45
24	Elise Léonard	Inconnue	Juniors Femmes	12,82	-2.1 m/s	12,61
25	Jutta Decock	Katholieke Universiteit Leuven	Seniors Femmes	12,88	-1.3 m/s	12,89
26	Chloé Violle	Université de Liège (site de Liège)	Seniors Femmes	12,88	-0.6 m/s	12,78

27	 Sara Roggeman	Universiteit Gent	Juniors Femmes	12,92	-1.3 m/s	12,97
28	 Chloe O'Shea	Université Catholique de Louvain	Seniors Femmes	12,93	-0.6 m/s	 12,81
29	 Lisa De Troyer	Hogeschool Gent	Juniors Femmes	12,94	-0.1 m/s	13,06
30	 Ellen Anckaert	1 Open meeting - geen student	Scolaires Femmes	 13,00	-0.1 m/s	13,08
31	 Lotte Van der Vreken	Universiteit Gent	Seniors Femmes	 13,00	-0.6 m/s	12,81
32	 Emeline Lippens	1 Open meeting - geen student	Scolaires Femmes	13,01	-0.6 m/s	13,21
33	 Nande De Kimpe	1 Open meeting - geen student	Scolaires Femmes	 13,03	-0.6 m/s	12,80
34	 Charlotte Kinable	Katholieke Universiteit Leuven	Seniors Femmes	 13,03	-2.1 m/s	12,46
35	 Emma Hiel	Arteveldehogeschool	Seniors Femmes	13,04	-1.3 m/s	12,93
36	 Valentine Anyanwu	Université Catholique de Louvain	Juniors Femmes	13,07	-0.6 m/s	12,78
37	 Bente Van Ingelgem	1 Open meeting - geen student	Cadets Femmes	13,09	-0.2 m/s	13,67
38	 Eléa Godeau	1 Open meeting - geen student	Juniors Femmes	13,10	-1.3 m/s	12,94
39	 Lore Van den Bremt	Arteveldehogeschool	Seniors Femmes	13,11	-0.1 m/s	12,97
40	 Yana Goosen	1 Open meeting - geen student	Juniors Femmes	13,12	-1.3 m/s	 12,90
41	 Iris Lefevere	1 Open meeting - geen student	Scolaires Femmes	 13,23	+0.4 m/s	13,82
42	 Estelle Jennes	Université de Liège (site de Liège)	Juniors Femmes	 13,23	-0.1 m/s	13,14
43	 Anna De Gryze	Inconnue	Scolaires Femmes	 13,25	-1.3 m/s	12,88
44	 Laureen Cugnet-Evans	Université Catholique de Louvain	Seniors Femmes	 13,25	-0.1 m/s	12,99
45	 Emma Frans	HE Libre Mosane	Seniors Femmes	13,26	-0.6 m/s	13,18
46	 Yelena Boone	1 Open meeting - geen student	Juniors Femmes	 13,27	-1.3 m/s	12,91
47	 Zina Looverle	1 Open meeting - geen student	Scolaires Femmes	 13,27	-0.6 m/s	13,29
48	 Steffi De Saegher	Inconnue	Juniors Femmes	13,28	-2.1 m/s	12,61
49	 Anaëlle Rousseau	1 Open meeting - geen student	Scolaires Femmes	13,31	-0.6 m/s	 13,30
50	 Lisa Van Renterghem	Hogeschool Gent	Seniors Femmes	13,43	-0.2 m/s	13,43
51	 Monica Peñalver Garcia	HE Léonard de Vinci	Seniors Femmes	 13,45	-0.1 m/s	13,12
52	 Julia Alegre	Université de Liège (site de Liège)	Seniors Femmes	 13,45	+0.4 m/s	13,69
53	 Riet Van Aerschot	Inconnue	Juniors Femmes	13,47	-0.6 m/s	13,23
54	 Miek Lagaeyse	Universiteit Gent	Juniors Femmes	13,49	+0.4 m/s	13,84
55	 Anne-Ramon Cole	Vrije Universiteit Brussel	Juniors Femmes	 13,55	-0.2 m/s	13,40
56	 Saartje Lansen	1 Open meeting - geen student	Scolaires Femmes	 13,55	-1.3 m/s	12,90
57	 Maimouna Cisse	Inconnue	Scolaires Femmes	13,59	-0.1 m/s	13,14
58	 Jeanne Swaelens	Inconnue	Juniors Femmes	13,63	-0.2 m/s	13,34
59	 France Vande Cavey	Inconnue	Juniors Femmes	13,65	-0.1 m/s	13,17
60	 Clara Ruzziconi	HE Libre Mosane	Seniors Femmes	13,73	-0.6 m/s	13,32
61	 Myrthe Gobert	Universiteit Antwerpen	Seniors Femmes	13,80	-0.2 m/s	13,57
62	 Camille Chauvin	HE Provinciale du Hainaut-Condorcet	Seniors Femmes	 13,82	+0.4 m/s	13,91
63	 Elise Romeyns	Inconnue	Scolaires Femmes	 13,82	+0.4 m/s	13,91
64	 Kaat Smet	1 Open meeting - geen student	Cadets Femmes	13,87	-0.4 m/s	14,46
65	 Maëva Defosse	Université de Mons	Seniors Femmes	13,90	-0.2 m/s	13,36
66	 Caitlin Verleysen	Karel de Grote Hogeschool	Juniors Femmes	13,93	-0.6 m/s	13,31
67	 Orligane Manteau	HE Provinciale du Hainaut-Condorcet	Seniors Femmes	 13,95	+0.4 m/s	14,07
68	 Paoline Debisschop	Université Catholique de Louvain	Seniors Femmes	 13,95	-0.6 m/s	13,33
69	 Rosanne Verbruggen	Katholieke Universiteit Leuven	Seniors Femmes	14,06	-0.4 m/s	14,10
70	 Jasmine Fonck	1 Open meeting - geen student	Scolaires Femmes	14,09	-0.5 m/s	---
71	 Lien Rubbrecht	Universiteit Gent	Seniors Femmes	14,14	-0.2 m/s	13,61
72	 Lucca Delos	1 Open meeting - geen student	Scolaires Femmes	 14,32	-0.4 m/s	14,37
73	 Mogan Heirman	1 Open meeting - geen student	Cadets Femmes	 14,32	-0.4 m/s	14,43
74	 Claire LE POULARD	Université de Liège (site de Liège)	Seniors Femmes	 14,32	-0.5 m/s	---
75	 Norah De Jaeger	Inconnue	Cadets Femmes	14,35	-0.4 m/s	14,39
76	 Lore REMBAUT	Inconnue	Scolaires Femmes	14,37	+0.4 m/s	14,05
77	 Elise Corthals	1 Open meeting - geen student	Cadets Femmes	14,50	-0.5 m/s	---
78	 Rose Nkake boluku	Inconnue	Scolaires Femmes	14,68	-0.5 m/s	---
79	 Ana Neckebroeck	1 Open meeting - geen student	Cadets Femmes	14,85	-0.5 m/s	14,86
80	 Nathalie Huynh	Université Catholique de Louvain	Seniors Femmes	14,88	-0.4 m/s	14,83
81	 Geike De Vriendt	1 Open meeting - geen student	Cadets Femmes	15,05	-0.5 m/s	14,89
	 Evelyn Huyghe	Universiteit Antwerpen	Seniors Femmes	DQ		14,68
	 Rachel Henno	HE Louvain en Hainaut	Seniors Femmes	DNS		---
	 May Lee Cooper	Université de Liège (site de Gembloux)	Seniors Femmes	DNS		12,77

Hommes- 800m

#	Nom	Club	Catégorie	Résultat	OBP
1	 Brent Soetens	Universiteit Gent	Seniors Hommes	1:53,02	1:53,23
2	 Victor Bettens	Hogeschool Gent	Seniors Hommes	1:53,47	1:54,75
3	 Joachim Bafort	Universiteit Gent	Seniors Hommes	1:53,72	1:54,28
4	 Korneel Weekers	Hogeschool UC Leuven	Seniors Hommes	1:54,54	1:54,80
5	 Thibau Van den Bussche	Arteveldehogeschool	Seniors Hommes	1:54,78	1:56,14
6	 Edouard Simon	Université Catholique de Louvain	Seniors Hommes	1:57,00	1:56,79
7	 Arne Boeykens	1 Open meeting - geen student	Seniors Hommes	1:57,54	1:56,54
8	 Dimitri Bertrand	HE de la Province de Liège	Seniors Hommes	1:57,76	1:56,59
9	 Reinbert Van Acker	1 Open meeting - geen student	Seniors Hommes	1:57,77	1:56,61
10	 Stanislav Driapko	1 Open meeting - geen student	Juniors Hommes	1:59,57	1:54,89
11	 Robin Soetens	1 Open meeting - geen student	Juniors Hommes	1:59,92	2:03,20
12	 Wouter Verstockt	1 Open meeting - geen student	Seniors Hommes	2:00,51	1:58,73
13	 Boris De Grelle	Université Catholique de Louvain	Seniors Hommes	2:02,16	 2:02,45
14	 Martijn Hus	Katholieke Universiteit Leuven	Seniors Hommes	2:02,49	2:01,00
15	 Bernard Laureys	Katholieke Universiteit Leuven	Seniors Hommes	2:02,52	1:59,28
16	 Jules Blanchart	1 Open meeting - geen student	Scolaires Hommes	2:02,62	2:04,60
17	 Laurens Blommaert	1 Open meeting - geen student	Scolaires Hommes	2:02,66	2:03,08
18	 Aurian Mathurin	Hogeschool West-Vlaanderen	Seniors Hommes	2:02,87	2:02,29
19	 Glen Smet	Katholieke Universiteit Leuven	Seniors Hommes	2:03,57	2:02,65
20	 Toon Vierbergen	1 Open meeting - geen student	Seniors Hommes	2:04,74	2:04,19
21	 Arjen De Meyer	Universiteit Gent	Seniors Hommes	2:05,51	2:05,39
22	 Maarten Vermaelen	Vrije Universiteit Brussel	Seniors Hommes	2:05,68	2:06,05
23	 Lucas Bastin	HE de Namur Liège Luxembourg	Seniors Hommes	2:06,67	2:09,15
24	 Corentin Beyaert	Vrije Universiteit Brussel	Seniors Hommes	2:07,17	2:07,81
25	 Nawfel Benouda	HE Léonard de Vinci	Seniors Hommes	2:07,87	2:05,19
26	 Geoffry Van De Velde	1 Open meeting - geen student	Seniors Hommes	2:08,73	2:09,73
27	 Cédric Van Den Berge	Inconnue	Masters Hommes	2:09,78	2:06,82
28	 Gabriël Lauwereys	Inconnue	Juniors Hommes	2:10,70	2:08,88
29	 Miguel Van de Sype	1 Open meeting - geen student	Seniors Hommes	2:15,25	---
30	 Arnaud Vermoesen	Inconnue	Cadets Hommes	2:15,45	2:17,16
31	 Basile De Vos	1 Open meeting - geen student	Cadets Hommes	2:16,91	2:18,75
32	 Seth Van Cauwenbergh	1 Open meeting - geen student	Cadets Hommes	2:19,35	---
33	 Ilano Broekaert	1 Open meeting - geen student	Cadets Hommes	2:22,17	2:21,70
34	 Loui De Bilde	1 Open meeting - geen student	Cadets Hommes	2:32,59	2:31,93
35	 André Goffart	HE Libre Mosane	Seniors Hommes	2:43,77	---
	 Stijn Van Nieuwenhove	Hogeschool Gent	Seniors Hommes	DNF	1:52,49

Dames- 800m

#	Nom	Club	Catégorie	Résultat	OBP
1	 Mariska Parewyck	Inconnue	Seniors Femmes	2:05,01	2:04,22
2	 Lucie Grandjean	Université Catholique de Louvain	Seniors Femmes	2:11,82	2:08,22
3	 Emma D'haene	Hogeschool Gent	Seniors Femmes	2:13,50	2:12,78
4	 Jacintha Cornelis	Universiteit Gent	Seniors Femmes	2:13,79	2:08,66
5	 Sophie Laloux	Université Catholique de Louvain -St Louis	Seniors Femmes	2:14,50	2:15,22
6	 Marine Joblin	HE Bruxelles - Brabant	Seniors Femmes	2:15,70	2:11,27
7	 Océane Kouassi Aka	Université Libre de Bruxelles	Seniors Femmes	2:17,73	2:17,52
8	 Esther Callebaut	1 Open meeting - geen student	Cadets Femmes	2:21,31	2:24,48
9	 Amélie Paulart	Université Catholique de Louvain	Juniors Femmes	2:21,79	2:20,86
10	 Josephine De Brouwer	Inconnue	Juniors Femmes	2:24,77	2:23,80
11	 Jente Van Droogenbroeck	Arteveldehogeschool	Seniors Femmes	2:29,16	2:29,14
12	 Isabelle Godefridi	1 Open meeting - geen student	Seniors Femmes	2:29,87	2:29,66
13	 Liesl Luysen	Universiteit Gent	Seniors Femmes	2:32,83	2:35,48
14	 Femke Ysewyn	Odisee Hogeschool	Seniors Femmes	2:34,92	2:25,35
15	 Ella Bauwens	1 Open meeting - geen student	Scolaires Femmes	2:36,94	2:31,44
16	 Alia Frahtia	Université Catholique de Louvain	Seniors Femmes	2:40,50	---
17	 Hanne Van de Casseye	1 Open meeting - geen student	Seniors Femmes	2:42,60	2:36,68
18	 Fran Bauwens	1 Open meeting - geen student	Cadets Femmes	2:46,92	---
19	 Samantha Geeroms	Thomas More	Seniors Femmes	2:49,10	2:45,73
20	 Alicia De Grave	1 Open meeting - geen student	Cadets Femmes	2:50,37	2:53,19
21	 Kendra Audenaert	1 Open meeting - geen student	Seniors Femmes	2:50,69	---
22	 Hasse Mertens	Universiteit Gent	Juniors Femmes	2:50,74	2:30,34
23	 Larissa Huyck	Universiteit Gent	Juniors Femmes	2:51,55	2:34,92
24	 Veerle Van Campenhout	1 Open meeting - geen student	Masters Femmes	2:52,18	2:50,45
25	 Dorien Van Doorselaere	1 Open meeting - geen student	Cadets Femmes	2:53,09	---
26	 Faustine Viart	Université de Namur	Seniors Femmes	2:56,59	2:54,82
27	 Louise Devloo	Universiteit Gent	Seniors Femmes	3:00,67	---
28	 Lutgard De Clercq	Inconnue	Seniors Femmes	3:03,38	2:55,71

Hommes- 400m

#	Nom	Club	Catégorie	Résultat	OBP
1	 Robin Vanderbemden	Université de Liège (site de Liège)	Seniors Hommes	46,68	 46,00
2	 Dylan Owusu	1 Open meeting - geen student	Seniors Hommes	48,36	48,00
3	 Ruben Verheyden	Universiteit Gent	Seniors Hommes	48,96	48,97
4	 Mathys Latinne	Université Catholique de Louvain	Seniors Hommes	48,97	49,91
5	 Gaëtan Chiroux	1 Open meeting - geen student	Seniors Hommes	49,71	49,66
6	 Clément Hendrick	Université Libre de Bruxelles	Seniors Hommes	49,74	48,38
7	 Louis Smeets	1 Open meeting - geen student	Scolaires Hommes	49,88	50,84
8	 Wout Van Hoof	Universiteit Gent	Juniors Hommes	50,33	51,10
9	 Robbert Heylen	1 Open meeting - geen student	Seniors Hommes	50,40	48,90
10	 Hugues Kabuya	HE Francisco Ferrer	Seniors Hommes	50,90	49,97
11	 Jérôme Ruth	1 Open meeting - geen student	Seniors Hommes	51,43	49,59
12	 Rob Van den Bogaert	Hogeschool Gent	Seniors Hommes	52,20	50,95
13	 Jenten Goeteyn	Inconnue	Seniors Hommes	 52,33	50,94
14	 Siebe Hauttekeete	Universiteit Gent	Juniors Hommes	 52,33	52,40
15	 Simon Dennetiere	Inconnue	Seniors Hommes	52,40	 52,65
16	 Christof Pieters	1 Open meeting - geen student	Masters Hommes	52,71	52,43
17	 Antoine Bodart	1 Open meeting - geen student	Seniors Hommes	52,78	52,75
18	 Pierre Laloux	Université Catholique de Louvain	Seniors Hommes	52,86	52,25
19	 Quentin Dujardin	1 Open meeting - geen student	Seniors Hommes	52,88	54,44
20	 Hendrik Heylen	Katholieke Universiteit Leuven	Seniors Hommes	53,09	---
21	 Emiel Dieussaert	Universiteit Gent	Seniors Hommes	53,48	53,58
22	 Lois Dejasse	Université Catholique de Louvain	Juniors Hommes	53,64	53,07
23	 Pieter Vandenborne	1 Open meeting - geen student	Seniors Hommes	53,80	52,89
24	 Luka Afschrift	1 Open meeting - geen student	Scolaires Hommes	54,02	53,12
25	 Louis Pecheur	Université Catholique de Louvain	Seniors Hommes	54,21	54,17
26	 Tiago Dekie	1 Open meeting - geen student	Cadets Hommes	54,25	53,74
27	 Jonas Huyck	Katholieke Universiteit Leuven	Seniors Hommes	54,35	54,69
28	 Luka Claeys	Inconnue	Juniors Hommes	54,38	52,47
29	 Joris Paquot	Erasmus Hogeschool Brussel	Juniors Hommes	54,62	55,88
30	 Souhaïb Azzouz	Université Catholique de Louvain	Seniors Hommes	54,64	51,73
31	 Simon Vanneste	1 Open meeting - geen student	Seniors Hommes	54,79	---
32	 Kobe Lauwereys	1 Open meeting - geen student	Juniors Hommes	55,53	57,44
33	 Tibo Verstockt	1 Open meeting - geen student	Seniors Hommes	55,64	56,34
34	 Oscar Mues	Katholieke Universiteit Leuven	Scolaires Hommes	55,72	54,72
35	 Nawfel Benouda	HE Léonard de Vinci	Seniors Hommes	56,25	54,91
36	 Antonio Jara	1 Open meeting - geen student	Masters Hommes	57,63	57,40

Dames- 400m

#	Nom	Club	Catégorie	Résultat	OBP
1	 Benedikt Tchimou	Inconnue	Seniors Femmes	55,31	55,15
2	 Geraldine Dheur	Université Catholique de Louvain	Seniors Femmes	55,43	56,56
3	 Jana Kluskens	Hogeschool Gent	Juniors Femmes	55,71	55,64
4	 Cloë Van der Meulen	Universiteit Gent	Seniors Femmes	55,76	---
5	 Marie Fickers	1 Open meeting - geen student	Seniors Femmes	56,25	56,35
6	 Jenna De Smet	Universiteit Gent	Seniors Femmes	56,92	57,44
7	 Jitse Steenmans	Katholieke Universiteit Leuven	Seniors Femmes	57,40	58,00
8	 Ine Hugaerts	Katholieke Universiteit Leuven	Seniors Femmes	57,40	57,96
9	 Claire Jacobs	Université Catholique de Louvain	Juniors Femmes	57,59	57,86
10	 Hanna Vereecke	Vrije Universiteit Brussel	Seniors Femmes	57,67	56,85
11	 Hanne Maudens	Universiteit Gent	Seniors Femmes	58,35	53,06
12	 Myrthe Baeten	1 Open meeting - geen student	Scolaires Femmes	58,51	58,47
13	 Amelie Sonneville	Universiteit Gent	Juniors Femmes	58,94	58,63
14	 Jienity De kler	Universiteit Gent	Seniors Femmes	59,05	---
15	 Ilkje De Vlieger	Vrije Universiteit Brussel	Seniors Femmes	59,09	59,40
16	 Ines Gbedassi	Hogeschool UC Leuven	Seniors Femmes	59,10	57,80
17	 Clara De Vare	Katholieke Universiteit Leuven	Juniors Femmes	59,16	58,09
18	 Janne Hermans	1 Open meeting - geen student	Scolaires Femmes	59,34	59,43
19	 Hannelore Heymans	1 Open meeting - geen student	Juniors Femmes	1:00,04	59,53
20	 Hege Michiels	Inconnue	Seniors Femmes	1:00,07	59,18
21	 Timea Huyck	Universiteit Gent	Juniors Femmes	1:00,30	1:00,19
22	 Jolein De Rocker	Hogeschool Gent	Seniors Femmes	1:00,52	1:01,54
23	 Eva Jaspers	1 Open meeting - geen student	Scolaires Femmes	1:01,00	1:03,27
24	 Sara Wyns	Vrije Universiteit Brussel	Seniors Femmes	1:01,25	59,58
25	 Elise Léonard	1 Open meeting - geen student	Scolaires Femmes	1:01,54	1:02,20
26	 Robin Degrève	Universiteit Gent	Seniors Femmes	1:02,20	57,02
27	 Anke Sirjacobs	1 Open meeting - geen student	Scolaires Femmes	1:02,29	1:02,15
28	 Anouk De Smet	1 Open meeting - geen student	Cadets Femmes	1:03,23	1:03,32
29	 Ellen Samassi Scott	1 Open meeting - geen student	Cadets Femmes	1:03,39	1:06,19
30	 Elsa De Greef	Université Catholique de Louvain	Seniors Femmes	1:03,56	1:02,22
31	 Chloë Scheirlinckx	Université Catholique de Louvain	Seniors Femmes	1:03,67	1:04,17
32	 Miet Parmentier	1 Open meeting - geen student	Seniors Femmes	1:03,93	1:04,35
33	 Line Lauwers	1 Open meeting - geen student	Cadets Femmes	1:04,27	1:06,09
34	 Clémence Colassin	Université Catholique de Louvain	Seniors Femmes	1:05,58	1:04,80
35	 Stephanie Detaellenaere	1 Open meeting - geen student	Seniors Femmes	1:05,70	1:05,65
36	 Sybil Vandamme	Ecole Pratiques des Hautes études Commerciales	Seniors Femmes	1:06,84	1:03,97
37	 Marlies Ceulemans	1 Open meeting - geen student	Seniors Femmes	1:08,09	1:06,42
38	 Nina Michiels	1 Open meeting - geen student	Cadets Femmes	1:09,99	1:08,32
39	 Cindy D'Hondt	Universiteit Gent	Seniors Femmes	1:12,50	---
	 Laure Van Den Abeele	Université Catholique de Louvain	Seniors Femmes	DNF	57,88

Hommes- 200m











#	Nom	Club	Catégorie	Résultat		OBP
1	 Adrien Devriendt	Inconnue	Seniors Hommes	21,11	-0.5 m/s	21,41
2	 Lionel Halleux	Université Catholique de Louvain	Seniors Hommes	21,63	-0.5 m/s	21,59
3	 Geoffrey Jacques	HE Libre Mosane	Seniors Hommes	21,67	-0.5 m/s	21,58
4	 Antoine Snyders	HE Libre Mosane	Seniors Hommes	21,68	-0.5 m/s	21,26
5	 Camille Snyders	HE de la Province de Liège	Seniors Hommes	21,74	-0.5 m/s	21,66
6	 Xavier Rousseau	1 Open meeting - geen student	Scolaires Hommes	22,00	-0.5 m/s	 21,98
7	 Clément Brunin	1 Open meeting - geen student	Seniors Hommes	22,03	-0.5 m/s	21,90
8	 Florian Dehout	HE Louvain en Hainaut	Seniors Hommes	22,09	-0.5 m/s	21,99
9	 Dries Van Nieuwenhove	Hogeschool Gent	Seniors Hommes	22,13	-0.5 m/s	21,73
10	 Jasper Annys	Hogeschool VIVES	Seniors Hommes	22,21	-0.5 m/s	21,93
11	 Sébastien Lins	Inconnue	Seniors Hommes	 22,31	-0.5 m/s	21,53
12	 Wout Bex	Universiteit Gent	Seniors Hommes	 22,31	-1.2 m/s	22,07
13	 Meindert Caudron	Inconnue	Juniors Hommes	22,35	-0.5 m/s	21,85
14	 Tibe Temmerman	Inconnue	Juniors Hommes	22,40	-1.2 m/s	22,47
15	 Bjirsen Deherder	1 Open meeting - geen student	Seniors Hommes	22,42	-0.7 m/s	22,66
16	 Gautier Brichet	HE Léonard de Vinci	Seniors Hommes	22,46	-0.7 m/s	22,93
17	 Marko Medan	Université Libre de Bruxelles	Seniors Hommes	22,47	-1.2 m/s	22,09
18	 Jitse Mievis	Erasmus Hogeschool Brussel	Seniors Hommes	22,50	-0.5 m/s	21,83
19	 Stijn Van der Vreken	Hogeschool Gent	Juniors Hommes	22,56	-1.2 m/s	22,02
20	 Quentin Chevallier-Appert	1 Open meeting - geen student	Scolaires Hommes	22,57	-0.7 m/s	22,76
21	 Thomas Van Ingelgem	1 Open meeting - geen student	Masters Hommes	22,66	-1.2 m/s	22,31
22	 Jordy Van Lierde	Universiteit Gent	Seniors Hommes	22,70	-0.4 m/s	23,32
23	 Quentin Hoffken	1 Open meeting - geen student	Juniors Hommes	22,74	-0.7 m/s	22,84
24	 Siemen Masure	Universiteit Gent	Seniors Hommes	22,77	-0.5 m/s	21,85
25	 Charles Hamaide	1 Open meeting - geen student	Seniors Hommes	22,88	-0.7 m/s	22,88
26	 Storm Tuyls	Hogeschool Gent	Seniors Hommes	22,92	-1.2 m/s	22,35
27	 Jarne Mariën	Universiteit Antwerpen	Juniors Hommes	23,07	-0.4 m/s	22,94
28	 Alexander Van Vliet	Universiteit Gent	Juniors Hommes	23,10	+1.3 m/s	 23,95
29	 Jean-Charles Nsangolo	1 Open meeting - geen student	Seniors Hommes	23,11	-0.4 m/s	23,38
30	 Laurens Francois	Universiteit Gent	Seniors Hommes	23,15	-0.7 m/s	22,69
31	 Jasper Vermaelen	1 Open meeting - geen student	Juniors Hommes	23,26	+1.3 m/s	23,58
32	 Simon Cotton	HE Louvain en Hainaut	Seniors Hommes	23,37	-1.2 m/s	22,53
33	 Driss Vergels	Inconnue	Juniors Hommes	23,45	+1.3 m/s	23,62
34	 Arthur Agbassa	Inconnue	Juniors Hommes	23,47	-0.4 m/s	23,12
35	 Mateo Loforte	HE Libre Mosane	Seniors Hommes	23,53	+1.3 m/s	23,77
36	 Stef Ruyssinck	1 Open meeting - geen student	Scolaires Hommes	23,67	+1.3 m/s	23,54
37	 Gertjan Demeur	1 Open meeting - geen student	Seniors Hommes	23,68	+1.3 m/s	23,58
38	 Titouan Danno	Université Libre de Bruxelles	Seniors Hommes	23,81	+0.6 m/s	---
39	 Ethan Sébastien Dumont	HE Provinciale du Hainaut-Condorcet	Seniors Hommes	24,14	+0.5 m/s	 24,73
40	 Ludovic Fenaux	1 Open meeting - geen student	Masters Hommes	24,16	-0.4 m/s	23,42
41	 Melchizedek Agyemang	Hogeschool Gent	Seniors Hommes	24,31	+1.3 m/s	24,19
42	 Jakob Verleyen	1 Open meeting - geen student	Cadets Hommes	24,56	+0.6 m/s	26,32
43	 Louis Pecheur	Université Catholique de Louvain	Seniors Hommes	24,65	+1.3 m/s	24,09
44	 Luca D'hooghe	1 Open meeting - geen student	Cadets Hommes	24,69	+0.5 m/s	24,85
45	 Jan Matthys	Universiteit Gent	Seniors Hommes	24,81	+0.5 m/s	25,51
46	 Jonas De smet	Inconnue	Seniors Hommes	24,89	-0.5 m/s	21,47
47	 Noël Ackaert	1 Open meeting - geen student	Masters Hommes	24,92	+0.5 m/s	25,24
48	 Wouter Vander Mijnsbrugge	1 Open meeting - geen student	Seniors Hommes	25,02	+0.5 m/s	25,14
49	 Benjamin Jolis	Université de Liège (site de Liège)	Seniors Hommes	25,32	+0.6 m/s	---
50	 Joppe Gutschoven	1 Open meeting - geen student	Scolaires Hommes	25,46	+0.5 m/s	26,21
51	 Tristan Bistrussu	1 Open meeting - geen student	Juniors Hommes	25,73	+0.6 m/s	26,70
52	 Pascal Rijdant	1 Open meeting - geen student	Masters Hommes	26,46	+0.5 m/s	26,07
53	 MAXIME Piedboeuf	HE de la Province de Liège	Juniors Hommes	26,95	+0.6 m/s	27,17
54	 Gil Talon	Inconnue	Seniors Hommes	27,10	+0.6 m/s	27,77
55	 Aurélien Belle	HE Louvain en Hainaut	Seniors Hommes	27,97	+0.6 m/s	---
56	 Michaël De Prins	Karel de Grote Hogeschool	Seniors Hommes	28,27	+0.6 m/s	27,84
	 Reginald Beele	Inconnue	Seniors Hommes	DNS		22,98
	 Nicolas Léonard	HE Léonard de Vinci	Seniors Hommes	DNS		22,62
	 Ali Lachkar	Université Libre de Bruxelles	Seniors Hommes	DNS		23,22
	 Matisse Barbio	1 Open meeting - geen student	Juniors Hommes	DNS		25,08
	 Enguerran Bossicard	HE Louvain en Hainaut	Seniors Hommes	DNF		21,71
	 Hadrien Wimlot	Université Libre de Bruxelles	Seniors Hommes	DNF		22,66
	 Olivier Baro	1 Open meeting - geen student	Seniors Hommes	DNF		23,24
	 Dorian André	1 Open meeting - geen student	Seniors Hommes	DNF		22,62

Dames- 200m

#	Nom	Club	Catégorie	Résultat		OBP
1	 Rani Vincke	Universiteit Gent	Seniors Femmes	23,97	-0.8 m/s	23,72
2	 Janie De Naeyer	Universiteit Antwerpen	Seniors Femmes	24,08	-0.6 m/s	 24,76
3	 Emma Broze	HE Léonard de Vinci	Seniors Femmes	24,58	-0.8 m/s	24,67
4	 Anouchka Kadiamba	Hogeschool Gent	Seniors Femmes	24,67	-0.8 m/s	24,55
5	 Cloe CHAVEPEYER	HE Louvain en Hainaut	Seniors Femmes	24,70	-0.8 m/s	24,10
6	 Sarah-Daisy Tshiamala-Bitota	HE Louvain en Hainaut	Seniors Femmes	24,77	-0.8 m/s	24,23
7	 Noor Vermeiren	1 Open meeting - geen student	Juniors Femmes	24,82	-0.6 m/s	25,12
8	 Camille Sonneville	1 Open meeting - geen student	Scolaires Femmes	24,83	-0.6 m/s	24,91
9	 Libelia Vincke	Hogeschool West-Vlaanderen	Seniors Femmes	24,93	-0.8 m/s	24,72
10	 Eline Claeys	Universiteit Gent	Seniors Femmes	25,06	-0.8 m/s	24,54
11	 Tinne Vertongen	1 Open meeting - geen student	Juniors Femmes	25,14	-0.8 m/s	24,27
12	 Manon De Marez	1 Open meeting - geen student	Seniors Femmes	25,31	+0.9 m/s	25,69
13	 Iris Bollengier	1 Open meeting - geen student	Scolaires Femmes	25,35	-0.5 m/s	26,08
14	 Zoë Willemyns	1 Open meeting - geen student	Scolaires Femmes	25,50	+0.9 m/s	25,79
15	 Nona Heyvaert	1 Open meeting - geen student	Juniors Femmes	25,80	-0.6 m/s	25,53
16	 Chloé Violle	Université de Liège (site de Liège)	Seniors Femmes	25,82	-0.5 m/s	25,88
17	 Dora De Haseleer	Université Catholique de Louvain	Seniors Femmes	25,95	-0.6 m/s	25,68
18	 Laure Van Den Abeele	Université Catholique de Louvain	Seniors Femmes	25,98	+0.9 m/s	25,73
19	 Jutta Decock	Katholieke Universiteit Leuven	Seniors Femmes	26,01	-0.2 m/s	26,32
20	 Caroline Vanhamme	Université Catholique de Louvain	Seniors Femmes	26,07	-0.5 m/s	26,00
21	 Ellen Anckaert	1 Open meeting - geen student	Scolaires Femmes	26,09	-0.2 m/s	26,34
22	 Laureen Cugnet-Evans	Université Catholique de Louvain	Seniors Femmes	26,12	+0.9 m/s	25,86
23	 Emeline Lippens	1 Open meeting - geen student	Scolaires Femmes	26,20	-0.6 m/s	25,37
24	 Chloë O'Shea	Université Catholique de Louvain	Seniors Femmes	26,21	-0.5 m/s	 26,07
25	 Bente Van Ingelgem	1 Open meeting - geen student	Cadets Femmes	 26,35	-0.5 m/s	26,79
26	 Valentine Anyanwu	Université Catholique de Louvain	Juniors Femmes	 26,35	-0.5 m/s	26,12

27	 Lisa De Troyer	Hogeschool Gent	Juniors Femmes	26,37	-0.5 m/s	26,72
28	 Emma Hiel	Arteveldehogeschool	Seniors Femmes	26,37	-0.5 m/s	26,04
29	 Lotte Van der Vreken	Universiteit Gent	Seniors Femmes	26,38	-0.2 m/s	26,37
30	 Eléa Godeau	1 Open meeting - geen student	Juniors Femmes	26,40	+0.9 m/s	25,85
31	 Zina Looverie	1 Open meeting - geen student	Scolaires Femmes	26,51	-0.2 m/s	26,63
32	 Yelena Boone	1 Open meeting - geen student	Juniors Femmes	26,54	+0.9 m/s	25,83
33	 Amélie Sonnevillie	Universiteit Gent	Juniors Femmes	26,60	-0.2 m/s	26,25
34	 Lisa Van Renterghem	Hogeschool Gent	Seniors Femmes	26,60	-0.2 m/s	26,68
35	 Anaëlle Rousseau	1 Open meeting - geen student	Scolaires Femmes	26,67	-0.2 m/s	26,42
36	 Nande De Kimpe	1 Open meeting - geen student	Scolaires Femmes	26,72	-0.5 m/s	26,21
37	 Lorien Aelbrecht	1 Open meeting - geen student	Juniors Femmes	26,76	-0.5 m/s	27,06
38	 Saartje Lansén	1 Open meeting - geen student	Scolaires Femmes	26,92	+0.9 m/s	25,71
39	 Lore Van den Bremt	Arteveldehogeschool	Seniors Femmes	26,93	-0.5 m/s	26,72
40	 Elisa Desmet	Hogeschool VIVES	Seniors Femmes	26,93	-0.2 m/s	26,66
41	 Emma Frans	HE Libre Mosane	Seniors Femmes	27,06	-0.5 m/s	27,28
42	 Yuna Hermans	Karel de Grote Hogeschool	Juniors Femmes	27,06	-0.5 m/s	27,11
43	 Estelle Jennes	Université de Liège (site de Liège)	Juniors Femmes	27,07	-0.5 m/s	27,33
44	 Anne-Ramon Cole	Vrije Universiteit Brussel	Juniors Femmes	27,31	-0.5 m/s	27,22
45	 Iris Lefevère	1 Open meeting - geen student	Scolaires Femmes	27,60	-1.0 m/s	28,66
46	 France Vande Cavey	Inconnue	Juniors Femmes	27,61	-0.5 m/s	26,84
47	 Riet Van Aerschot	Inconnue	Juniors Femmes	27,70	-0.5 m/s	27,22
48	 Miek Lagaeyse	Universiteit Gent	Juniors Femmes	27,94	-0.5 m/s	27,93
49	 Camille Chauvin	HE Provinciale du Hainaut-Condorcet	Seniors Femmes	27,97	-0.7 m/s	---
50	 Elise Romeyns	Inconnue	Scolaires Femmes	28,16	-0.5 m/s	28,31
51	 Alessia Petrella	Universiteit Gent	Seniors Femmes	28,23	-1.0 m/s	28,99
52	 Myrthe Gobert	Universiteit Antwerpen	Seniors Femmes	28,45	-0.5 m/s	27,77
53	 Clara Ruzziconi	HE Libre Mosane	Seniors Femmes	28,47	-1.0 m/s	28,49
54	 Kaat Smet	1 Open meeting - geen student	Cadets Femmes	28,58	-1.0 m/s	28,76
55	 Charlotte Kinable	Katholieke Universiteit Leuven	Seniors Femmes	28,61	-0.5 m/s	26,23
56	 Caltlin Verleysen	Karel de Grote Hogeschool	Juniors Femmes	28,64	-0.5 m/s	27,70
57	 Jasmine Fonck	1 Open meeting - geen student	Scolaires Femmes	28,87	-1.0 m/s	28,99
58	 Orligane Manteau	HE Provinciale du Hainaut-Condorcet	Seniors Femmes	28,90	-1.0 m/s	29,36
59	 Lucca Delos	1 Open meeting - geen student	Scolaires Femmes	29,30	-0.6 m/s	29,84
60	 Lore REMBAUT	Inconnue	Scolaires Femmes	29,32	-1.0 m/s	28,62
61	 Evelyne Huyghe	Universiteit Antwerpen	Seniors Femmes	29,51	-0.6 m/s	29,93
62	 Sélène Van Wijnendaele	1 Open meeting - geen student	Cadets Femmes	29,60	-0.6 m/s	29,69
63	 Rosanne Verbruggen	Katholieke Universiteit Leuven	Seniors Femmes	29,61	-0.7 m/s	30,83
64	 Julia Alegre	Université de Liège (site de Liège)	Seniors Femmes	29,74	-0.6 m/s	29,51
65	 Norah De Jaeger	Inconnue	Cadets Femmes	29,78	-0.6 m/s	29,56
66	 Elise Corthals	1 Open meeting - geen student	Cadets Femmes	30,12	-0.7 m/s	30,86
67	 Ana Neckebroeck	1 Open meeting - geen student	Cadets Femmes	30,25	-0.7 m/s	30,99
68	 Nathalie Huynh	Université Catholique de Louvain	Seniors Femmes	30,29	-0.7 m/s	30,94
69	 Ulrike Piekanowski	1 Open meeting - geen student	Scolaires Femmes	30,30	-0.6 m/s	29,94
70	 Saar Van hoof	1 Open meeting - geen student	Juniors Femmes	30,67	-0.6 m/s	30,17
71	 Geike De Vriendt	1 Open meeting - geen student	Cadets Femmes	31,15	-0.7 m/s	31,08
	 Monica Peñalver Garcia	HE Léonard de Vinci	Seniors Femmes	DNS		---
	 Kyra Janssens	Vrije Universiteit Brussel	Seniors Femmes	DNS		 25,69
	 Sterre Provost	1 Open meeting - geen student	Scolaires Femmes	DNS		24,92
	 Chloe Philippe	1 Open meeting - geen student	Scolaires Femmes	DNS		25,72

Hombres- 400m haies

Série 1							
5	 1413 Daniel Segers	Inconnue	Seniors Hommes	91.4cm	53,46	1	53,32
3	 2490 Nils Romswinkel	Universiteit Gent	Seniors Hommes	91.4cm	55,07	2	55,65
4	 1437 Simon Lavigne	HE de Namur Liège Luxembourg	Seniors Hommes	91.4cm	56,72	3	54,11
6	 3573 Richard F Mayango	Thomas More	Seniors Hommes	91.4cm	57,13	4	58,54
7	 9000 Eduard Goffart Winkin	Katholieke Universiteit Leuven	Seniors Hommes	91.4cm	1:01,40	5	---
Série 2							
6	 9010 Christopher Hassaine	HE Provinciale du Hainaut-Condorcet	Seniors Hommes	91.4cm	54,53	1	---
7	 184 Alexandre Otjacques	Université Libre de Bruxelles	Juniors Hommes	91.4cm	55,17	2	---
5	 266 Arthur Agbassa	Inconnue	Juniors Hommes	91.4cm	1:00,93	3	---
3	 830 Milan De Hertogh	Katholieke Universiteit Leuven	Juniors Hommes	91.4cm	1:03,38	4	---
4	 722 Eli Timmerman	1 Open meeting - geen student	Juniors Hommes	91.4cm	1:04,21	5	---

#	Nom	Club	Catégorie	Hauteur des...	Résultat	OBP
1	Daniel Segers	Inconnue	Seniors Hommes	91.4cm	53,46	53,32
2	Christopher Hassaine	HE Provinciale du Hainaut-Condorcet	Seniors Hommes	91.4cm	54,53	---
3	Nils Romswinkel	Universiteit Gent	Seniors Hommes	91.4cm	55,07	55,65
4	Alexandre Otjacques	Université Libre de Bruxelles	Juniors Hommes	91.4cm	55,17	---
5	Simon Lavigne	HE de Namur Liège Luxembourg	Seniors Hommes	91.4cm	56,72	54,11
6	Richard F Mayango	Thomas More	Seniors Hommes	91.4cm	57,13	58,54
7	Arthur Agbassa	Inconnue	Juniors Hommes	91.4cm	1:00,93	---
8	Eduard Goffart Winkin	Katholieke Universiteit Leuven	Seniors Hommes	91.4cm	1:01,40	---
9	Milan De Hertogh	Katholieke Universiteit Leuven	Juniors Hommes	91.4cm	1:03,38	---
10	Eli Timmerman	1 Open meeting - geen student	Juniors Hommes	91.4cm	1:04,21	---

Dames- 400m haies

Série 1						
5	Zélie Boucquey	Inconnue	Juniors Femmes	76.2cm	1:02,49	1 1:03,77
4	Loike Vierendeels	Universiteit Gent	Seniors Femmes	76.2cm	1:02,86	2 1:03,66
6	Charline LEFEVRE	Université de Liège (site de Liège)	Seniors Femmes	76.2cm	1:03,46	3 1:04,57
7	Audrey Van der Haegen	Hogeschool Gent	Seniors Femmes	76.2cm	1:06,15	4 1:06,25
3	Maya Vanhee	Arteveldehogeschool	Juniors Femmes	76.2cm	1:06,69	5 1:05,31
Série 2						
6	Allegra Gürsoy	1 Open meeting - geen student	Scolaires Femmes	76.2cm	1:05,56	1 1:08,56
3	Jade Cowie	Inconnue	Juniors Femmes	76.2cm	1:08,21	2 1:06,35
5	Anke Vermaelen	Katholieke Universiteit Leuven	Seniors Femmes	76.2cm	1:08,60	3 1:08,06
4	Eline Fauconnier	Université Catholique de Louvain	Seniors Femmes	76.2cm	1:09,06	4 1:07,44
#	Nom	Club	Catégorie	Hauteur des...	Résultat	OBP
1	Zélie Boucquey	Inconnue	Juniors Femmes	76.2cm	1:02,49	1:03,77
2	Loike Vierendeels	Universiteit Gent	Seniors Femmes	76.2cm	1:02,86	1:03,66
3	Charline LEFEVRE	Université de Liège (site de Liège)	Seniors Femmes	76.2cm	1:03,46	1:04,57
4	Allegra Gürsoy	1 Open meeting - geen student	Scolaires Femmes	76.2cm	1:05,56	1:08,56
5	Audrey Van der Haegen	Hogeschool Gent	Seniors Femmes	76.2cm	1:06,15	1:06,25
6	Maya Vanhee	Arteveldehogeschool	Juniors Femmes	76.2cm	1:06,69	1:05,31
7	Jade Cowie	Inconnue	Juniors Femmes	76.2cm	1:08,21	1:06,35
8	Anke Vermaelen	Katholieke Universiteit Leuven	Seniors Femmes	76.2cm	1:08,60	1:08,06
9	Eline Fauconnier	Université Catholique de Louvain	Seniors Femmes	76.2cm	1:09,06	1:07,44

Hommes – 4 x 100m

#	Équipe relais	Club	N...	Athlete 1	Athlete 2	Athlete 3	Athlete 4	Catégorie	Résu...	O...
1	HELHa Sport	HE Louvain en Hainaut	4	T. Rositano	E. Bossicard	F. Dehout	S. Cotton	Seniors Hommes	42,53	---
2	KAAG	1 Open meeting - geen student	4	M. Nevejans	F. Coene	L. Wauters	A. Barbio	Scolaires Hommes	43,31	---
3	UCL2	Université Catholique de Louvain	4	M. Zgajewski	L. Iker	N. Koch	F. De Radigües	Seniors Hommes	45,11	---
4	Alle Cat mannen Vlierzele	1 Open meeting - geen student	4	E. Van Bleyenbergh	J. Verschuere	S. Ruysinck	J. Schollaert	Seniors Hommes	45,27	---
5	Schol A Jongens vlierzele	1 Open meeting - geen student	4	V. De Spiegeleire	S. Wageman	J. Claus	R. Van Hoorde	Scolaires Hommes	46,57	---

Dames – 4 x 100m

#	Équipe relais	Club	N...	Athlete 1	Athlete 2	Athlete 3	Athlete 4	Catégorie	Résu...	O...
1	Schol A meisjes vlierzele	1 Open meeting - geen student	4	L. Van De Wiele	I. Bollengier	A. Sirjacobs	U. Pieknowski	Scolaires Femmes	52,13	---
2	Kad A meisjes Vlierzele	Inconnue	4	M. Van Britsom	K. Smet	M. Heirman	E. Corthals	Cadets Femmes	53,74	---
3	VUB 4x100	Vrije Universiteit Brussel	4	K. Janssens	B. Waerzeggers	H. Chiara	S. Wyns	Seniors Femmes	54,52	---
4	Alle catg vrouwen Vlierzele	1 Open meeting - geen student	4	L. REMBAUT	L. Delos	J. Fonck	H. Everaert	Seniors Femmes	55,50	---
5	Kad B meisjes vlierzele	1 Open meeting - geen student	4	G. De Vriendt	A. Everaert	A. Neckebroek	S. Van Wijnendaele	Cadets Femmes	56,59	---

Hommes – 4 x 400m

#	Équipe re...	Club	N...	Athlete 1	Athlete 2	Athlete 3	Athlete 4	Catégorie	Résultat	O...
1	UCL 1	Université Catholique de Louvain	4	M. Zgajewski	B. De Grelle	V. Mullens	L. Dejasse	Seniors Hommes	3:37,83	---
2	UCL2	Université Catholique de Louvain	4	M. Azhigaliev	L. Pecheur	S. Fauconnier	S. Azzouz	Seniors Hommes	3:41,45	---
3	ULB	Université Libre de Bruxelles	4	S. Brial	N. Zampieri	P. Kerrand	M. Coiffé	Seniors Hommes	3:49,81	---

Dames – 4 x 400m

#	Équipe re...	Club	No...	Athlete 1	Athlete 2	Athlete 3	Athlete 4	Catégorie	Résultat	OBP
1	UCL1	Université Catholique de Louvain	4	L. Hübinger	A. Frahtia	M. Mazzoli	G. Louize	Seniors Femmes	4:48,24	---

Hommes- Lancer du poids

#	Nom	Club	Catégorie	Poids	P 1	P 2	P 3	P 4	P 5	P 6	Résu...	OBP
1	Andreas De Lathauwer	Odisee Hogeschool	Seniors Hommes	7.26kg	X	15,87	16,57	X	16,82	16,80	16,82	18,02
2	Wietse Vander Schelde	Katholieke Universiteit Leuven	Seniors Hommes	7.26kg	X	13,55	14,30	14,52	15,07	X	15,07	14,52
3	Leander Casteels	Hogeschool Gent	Seniors Hommes	7.26kg	13,21	13,77	X	13,34	X	X	13,77	14,53
4	Arnaud De Cremer	Universiteit Gent	Seniors Hommes	7.26kg	13,26	13,59	X	X	X	X	13,59	14,47
5	Jannes Boonen	Inconnue	Seniors Hommes	7.26kg	12,24	12,49	X	X	X	X	12,49	13,78
6	Joris Willems	1 Open meeting - geen student	Juniors Hommes	7.26kg	10,06	10,74	10,59	11,28	11,33	11,65	11,65	11,00
7	Dylan Volckaert	Universiteit Gent	Seniors Hommes	7.26kg	11,35	11,00	10,79	X	X	X	11,35	11,50
8	Dries Van de Vyver	Inconnue	Seniors Hommes	7.26kg	9,90	9,96	10,43	10,48	10,75	10,71	10,75	10,10
9	Sven Vereecken	Universiteit Gent	Seniors Hommes	7.26kg	8,82	9,23	9,81				9,81	10,43
10	Jelle Daems	Artesis Plantijn Hogeschool Antwerpen	Juniors Hommes	7.26kg	7,31	9,49	X				9,49	---
11	Riyaad El Amrani	Artesis Plantijn Hogeschool Antwerpen	Seniors Hommes	7.26kg	7,87	7,88	7,82				7,88	7,63
12	Jens Verduyckt	Universiteit Gent	Seniors Hommes	7.26kg	7,84	7,04	7,01				7,84	---
13	Benjamin Jolis	Université de Liège (site de Liège)	Seniors Hommes	7.26kg	6,79	7,35	6,33				7,35	---

Dames- Lancer du poids

#	Nom	Club	Catégorie	P...	P 1	P 2	P 3	P 4	P 5	P 6	Résu...	OBP
1	Florence Boeynaems	Artesis Plantijn Hogeschool Antwerpen	Seniors Femmes	4kg	12,80	11,99	13,08	12,49	12,55	13,46	13,46	13,98
2	Cassandre Evans	HE de la Province de Liège	Seniors Femmes	4kg	12,55	12,23	12,09	12,35	12,30	13,13	13,13	13,65
3	Hanne Maudens	Universiteit Gent	Seniors Femmes	4kg	12,52	12,87	12,57	11,94	X	X	12,87	13,55
4	Sena Tay	Inconnue	Juniors Femmes	4kg	11,74	X	12,34	12,07	12,72	12,18	12,72	12,73
5	Kelly Van Petegem	1 Open meeting - geen student	Seniors Femmes	4kg	11,27	11,11	11,76	X	11,34	12,39	12,39	11,36
6	Tyra Steur	Universiteit Gent	Seniors Femmes	4kg	11,53	11,68	11,66	11,87	11,88	12,03	12,03	12,60
7	Sara Van Hoyweghen	Universiteit Gent	Seniors Femmes	4kg	12,02	11,56	X	X	X	11,57	12,02	12,14
8	Gretel Canters	Hogeschool PXL	Seniors Femmes	4kg	11,87	11,61	11,96	-	-	-	11,96	12,47
9	Lien Rubbrecht	Universiteit Gent	Seniors Femmes	4kg	10,93	10,49	10,61				10,93	11,83
10	Maxence Coquyt	Universiteit Gent	Seniors Femmes	4kg	9,58	9,68	10,11				10,11	11,77
11	Phebe Vanderstraeten	1 Open meeting - geen student	Seniors Femmes	4kg	9,78	9,63	9,79				9,79	10,27
12	Silke Daems	Karel de Grote Hogeschool	Seniors Femmes	4kg	9,23	9,41	8,92				9,41	10,80
13	Sara Vanhalst	Universiteit Gent	Seniors Femmes	4kg	9,03	8,93	8,76				9,03	9,29
14	Helena Oste	Universiteit Gent	Seniors Femmes	4kg	X	X	8,89				8,89	10,28
15	Rune Vierendeels	Hogeschool Gent	Seniors Femmes	4kg	8,66	8,66	8,50				8,66	---
16	Alessia Kairet	HE Louvain en Hainaut	Seniors Femmes	4kg	6,39	6,37	7,01				7,01	7,75
	Laura Van den Brande	Inconnue	Seniors Femmes	4kg	-	-	-				DNS	11,96
	Nina Denolf	Universiteit Gent	Seniors Femmes	4kg	-	-	-				DNS	11,45
	Asgerdur Jana Agustsdottir	1 Open meeting - geen student	Seniors Femmes	4kg	-	-	-				DNS	12,68

Hommes- Triple saut

#	Nom	Club	Catégorie	P 1	P 2	P 3	P 4	P 5	P 6	Résu...	OBP	
1	Gregory Geerts	1 Open meeting - geen student	Seniors Hommes	14,07	14,35	14,17	X	-	X	14,35	-0.7 m/s	14,72
2	Tommy Soumahoro	Université Libre de Bruxelles	Seniors Hommes	13,83	13,89	X	13,69	-	13,98	13,98	-0.3 m/s	14,02
3	Raphaël Ekwalla-Mathieu	Inconnue	Seniors Hommes	X	12,80	12,92	12,88	X	X	12,92	+0.0 m/s	---
4	Thibault Guineberteau	HE Bruxelles - Brabant	Seniors Hommes	12,44	12,67	12,83	12,00	12,55	12,72	12,83	-0.6 m/s	13,07
5	Elias Van Bleyenbergh	1 Open meeting - geen student	Juniors Hommes	12,56	12,61	12,49	12,69	X	X	12,69	-0.8 m/s	12,59
6	Ismaël Diamé	HE Léonard de Vinci	Seniors Hommes	11,53	12,10	X	12,45	12,56	12,57	12,57	+0.0 m/s	12,97
7	Liam Sprangers	Universiteit Gent	Seniors Hommes	X	12,32	X	X	r		12,32	-0.7 m/s	13,02
8	Alexis Van Elsuwé	Université Libre de Bruxelles	Juniors Hommes	X	X	X	11,90	X	11,74	11,90	-0.4 m/s	12,39

Dames- Triple saut

#	Nom	Club	Catégorie	P 1	P 2	P 3	P 4	P 5	P 6	Résu...	OBP	
1	Ilona Masson	HE de la Province de Liège	Seniors Femmes	12,45	X	12,65	X	X	X	12,65	-0.2 m/s	12,91
2	Florence Amon	Erasmus Hogeschool Brussel	Seniors Femmes	11,81	12,12	X	11,60	X	X	12,12	-1.2 m/s	12,07
3	Jolijn Verhaeghe	Katholieke Universiteit Leuven	Seniors Femmes	X	11,19	X	11,11	11,61	X	11,61	-0.8 m/s	11,95
4	Margot Delbare	Universiteit Hasselt	Seniors Femmes	11,29	11,47	X	11,12	11,19	11,28	11,47	+0.5 m/s	11,84
5	Jana Horemans	Universiteit Hasselt	Seniors Femmes	X	11,09	10,97	11,02	11,05	11,02	11,09	-0.1 m/s	11,43
6	Bo Rens	Artesis Plantijn Hogeschool Antwerpen	Seniors Femmes	10,80	10,84	10,95	X	10,93	X	10,95	-0.6 m/s	11,30
7	Amandine Sampson	Université de Liège (site de Liège)	Seniors Femmes	10,51	X	X	10,52	X	10,79	10,79	-0.5 m/s	10,60
8	Maimouna Cisse	Inconnue	Scolaires Femmes	10,14	10,27	10,17	10,41	X	10,33	10,41	-0.5 m/s	10,62
9	An Vannieuwenhuysse	Inconnue	Seniors Femmes	10,23	X	X				10,23	+0.1 m/s	---

Hommes- Saut en hauteur

#	Nom	Club	Catégorie	1,65	1,70	1,75	1,80	1,85	1,90	1,95	2,00	2,05	2,08	2,11	2,14	Rés...	O...
1	Sten Geenens	Universiteit Gent	Seniors Hommes	-	-	-	-	-	O	-	O	O	O	XO	Xr	2,11	2,13
2	Jos Gamuela Ngamunegueta	Université Libre de Bruxelles	Seniors Hommes	-	-	-	-	-	O	O	O	O	X-	XO	XXX	2,11	2,09
3	Lucca Goossens	1 Open meeting - geen student	Scolaires Hommes	-	-	-	-	O	XO	XXX						1,90	1,91
4	Lennert Verduyn	Katholieke Universiteit Leuven	Seniors Hommes	-	-	O	O	O	XXO	XXX						1,90	1,95
4	Médéric Zgajewski	Université Catholique de Louvain	Seniors Hommes	-	O	O	O	O	XXO	XXX						1,90	1,96
6	Chao-Yuan Liu	Katholieke Universiteit Leuven	Seniors Hommes	-	-	-	O	O	XXX							1,85	1,86
7	Romain Stieltjes	1 Open meeting - geen student	Scolaires Hommes	-	O	O	XO	O	XXX							1,85	1,88
8	Lowie Wauters	1 Open meeting - geen student	Scolaires Hommes	O	O	O	XXO	O	XXX							1,85	1,91
9	Jean-Paul Ngongo-Essomba	Université Catholique de Louvain	Seniors Hommes	-	O	O	O	XXO	XXX							1,85	---
10	Ilias Arf	Inconnue	Juniors Hommes	-	O	O	O	XXX								1,80	1,87
11	Pierre Stavart	Katholieke Universiteit Leuven	Juniors Hommes	O	O	XXX										1,70	1,75
12	Melvin LEFEBVRE	HE Louvain en Hainaut	Seniors Hommes	O	XO	XXX										1,70	---
12	Charles TOURTOIS	Université Libre de Bruxelles	Seniors Hommes		XO	XXX										1,70	1,81
	Benjamin Jolis	Université de Liège (site de Liège)	Seniors Hommes	XXX												NM	---

Dames- Saut en hauteur

#	Nom	Club	Catégorie	1,40	1,45	1,50	1,55	1,60	1,65	1,70	1,75	1,78	1,80	Rés...	OBP
1	Yorunn Ligneel	Katholieke Universiteit Leuven	Seniors Femmes	-	-	-	-	-	O	O	XO	XO	XXX	1,78	1,83
2	Lana Clippe	Université Catholique de Louvain	Juniors Femmes	-	-	-	O	O	O	XXX				1,65	1,65
3	Océane Thiebot	Université Libre de Bruxelles	Seniors Femmes	-	-	O	XO	O	O	XXX				1,65	1,65
4	Lise Braux	Université Catholique de Louvain	Seniors Femmes	-	-	O	O	O	XXX					1,60	1,67
5	Lisa Clopterop	Universiteit Gent	Seniors Femmes	-	O	O	XO	XXX						1,55	1,66
6	Alicia De Grave	1 Open meeting - geen student	Cadets Femmes	O	O	XXX								1,45	1,45

Hommes- Saut à la perche

#	Nom	Club	Catégorie	3,61	3,81	4,01	4,21	4,41	4,51	4,61	4,71	4,81	4,91	Rés...	OBP
1	Baptiste Lanotte	Université Catholique de Louvain	Seniors Hommes	-	-	-	-	O	-	XO	O	XO	XXX	4,81	4,85
2	Victor Priem	Universiteit Gent	Juniors Hommes	-	-	-	-	-	XO	-	XXO	XXO	XXX	4,81	4,80
3	Pierre Straet	Université Catholique de Louvain	Seniors Hommes	-	-	-	-	-	O	XO	XO	XXX		4,71	5,20
4	Pierre Stavart	Katholieke Universiteit Leuven	Juniors Hommes	-	-	XO	O	O	XXX					4,41	4,61
5	Loïc Joannes	Université de Liège (site de Liège)	Seniors Hommes	-	-	-	-	XO	-	XXX				4,41	4,90
6	El Hadji Magatte Sene	Inconnue	Seniors Hommes	-	O	O	O	XXO	XXX					4,41	---
7	Thomas Van der Poel	Katholieke Universiteit Leuven	Seniors Hommes	-	-	-	O	XXX						4,21	4,51
8	Maxime Nolf	1 Open meeting - geen student	Seniors Hommes	-	-	XXO	O	XXX						4,21	4,75
9	Guillaume Gobin	HE Charlemagne	Seniors Hommes	-	-	O	XO	XXX						4,21	4,85
10	Clément Lanotte	Ecole Pratiques des Hautes études Commerciales	Seniors Hommes	-	-	O	XXO	XXX						4,21	4,01
11	Florent Hervers	Université de Liège (site de Liège)	Seniors Hommes	O	O	O	XXX							4,01	4,10
12	Ilias Arf	Inconnue	Juniors Hommes	-	XXO	XO	XXX							4,01	4,21
13	Charles TOURTOIS	Université Libre de Bruxelles	Seniors Hommes	O	XXO	XXX								3,81	3,91
14	Simon François	Inconnue	Seniors Hommes	XXO	XXX									3,61	4,12

Dames- Saut à la perche

#	Nom	Club	Catégorie	2,61	2,81	3,01	3,21	3,41	3,61	3,81	3,91	Rés...	OBP
1	Fleur Hooyberghs	Universiteit Gent	Seniors Femmes	-	-	-	-	-	XO	O	XXX	3,81	4,16
2	Dag-Ferene Van Cappellen	Odisee Hogeschool	Seniors Femmes	-	-	-	O	O	XXX			3,41	3,71
3	Hanne Vandenbroucke	Katholieke Universiteit Leuven	Seniors Femmes	-	O	O	XO	XXX				3,21	3,41
4	Caroline Bloch	HE de la Province de Liège	Seniors Femmes	-	-	O	XXX					3,01	3,50
4	Norah De Bruycker	1 Open meeting - geen student	Scolaires Femmes	-	O	O	XXX					3,01	3,37
6	Chloé Van de Sype	1 Open meeting - geen student	Seniors Femmes		O	XXO	XO	XXX				3,01	3,21
7	Mathilde De Meue	Université Catholique de Louvain	Seniors Femmes		O	XXX						2,61	3,22
	Charlotte Vanlangenaker	Katholieke Universiteit Leuven	Juniors Femmes	-	XXX							NM	3,25

Hommes- Saut en longueur

#	Nom	Club	Catégorie	P 1	P 2	P 3	P 4	P 5	P 6	Rés...	OBP	
1	Yannī Sampson	Université de Liège (site de Liège)	Juniors Hommes	X	6,87	6,82	X	7,09	X	7,09	-0.4 m/s	7,19
2	Thomas Van der Poel	Katholieke Universiteit Leuven	Seniors Hommes	6,76	7,01	4,82	6,86	6,95	7,05	7,05	-0.3 m/s	7,29
3	Florent Hervers	Université de Liège (site de Liège)	Seniors Hommes	6,39	6,72	4,30	6,55	6,56	7,01	7,01	-0.7 m/s	6,82
4	Jonas Vander Avert	Artesis Plantijn Hogeschool Antwerpen	Seniors Hommes	6,64	6,75	X	X	X	6,75	6,75	-0.9 m/s	6,99
5	Melvyn Claes	Université Catholique de Louvain	Seniors Hommes	6,17	6,53	6,53	6,75	6,53	6,65	6,75	-0.7 m/s	6,88
6	Arnaud Caluwé	1 Open meeting - geen student	Seniors Hommes	6,70	X	6,74	6,74	X	X	6,74	-0.5 m/s	7,28
7	Simon Dekoninck	Katholieke Universiteit Leuven	Juniors Hommes	6,64	6,44	6,64	X	6,73	X	6,73	-0.8 m/s	6,81
8	Björn De decker	1 Open meeting - geen student	Seniors Hommes	6,44	6,54	X	6,58	X	X	6,58	-0.1 m/s	7,32
9	Rune Wyns	Katholieke Universiteit Leuven	Juniors Hommes	6,03	6,15	6,48				6,48	-0.4 m/s	6,44
10	Thibault Guineberteau	HE Bruxelles - Brabant	Seniors Hommes	6,23	6,42	6,29				6,42	-0.5 m/s	6,49
11	Lucien Iker	Université Catholique de Louvain	Seniors Hommes	6,12	6,18	6,27				6,27	-1.7 m/s	6,40
12	Eduard Goffart Winkin	Katholieke Universiteit Leuven	Seniors Hommes	6,05	5,80	X				6,05	-0.4 m/s	---
13	Lucca Goossens	1 Open meeting - geen student	Scolaires Hommes	X	X	5,97				5,97	-0.4 m/s	6,44
14	Elias Van Bleyenbergh	1 Open meeting - geen student	Juniors Hommes	5,95	X	5,65				5,95	-0.4 m/s	6,47
15	Tim Colignon	Odisee Hogeschool	Seniors Hommes	5,02	5,77	5,93				5,93	-1.0 m/s	6,08
16	Mateo Loforte	HE Libre Mosane	Seniors Hommes	5,52	5,38	4,69				5,52	-0.9 m/s	---
17	Joachim Laus	1 Open meeting - geen student	Masters Hommes	5,42	5,23	5,47				5,47	-1.9 m/s	5,85
18	Nawfel Benouda	HE Léonard de Vinci	Seniors Hommes	5,03	5,37	5,44				5,44	-0.4 m/s	---
19	Elouan LANIER	HE Libre de Bruxelles	Seniors Hommes	5,16	5,07	5,41				5,41	-1.8 m/s	5,58
20	Amaury Meskens	Université Libre de Bruxelles	Seniors Hommes	4,94	5,19	4,71				5,19	-0.8 m/s	---
21	Benjamin Jolis	Université de Liège (site de Liège)	Seniors Hommes	4,39	4,25	5,18				5,18	-1.0 m/s	---
22	Jesse Claus	1 Open meeting - geen student	Cadets Hommes	4,91	4,57	4,79				4,91	-0.5 m/s	5,01
23	Lucas Batlle	Université de Liège (site de Liège)	Seniors Hommes	4,61	4,72	4,88				4,88	-0.1 m/s	---
24	Twan Glorieux	1 Open meeting - geen student	Cadets Hommes	4,56	4,04	3,70				4,56	+0.0 m/s	4,75
25	Siméon Collart	Inconnue	Cadets Hommes	3,84	4,05	3,89				4,05	+0.1 m/s	4,21

Dames- Saut en longueur

#	Nom	Club	Catégorie	P 1	P 2	P 3	P 4	P 5	P 6	Ré...	OBP	
1	Maité Beernaert	Katholieke Universiteit Leuven	Seniors Femmes	5,71	X	5,69	5,90	5,99	X	5,99	-0.9 m/s	6,01
2	Ilona Masson	HE de la Province de Liège	Seniors Femmes	X	5,85	X	X	X	X	5,85	-0.4 m/s	6,12
3	Laura Ooghe	1 Open meeting - geen student	Scolaires Femmes	5,83	5,82	X	5,84	X	5,69	5,84	-0.4 m/s	6,13
4	Jolijn Verhaeghe	Katholieke Universiteit Leuven	Seniors Femmes	X	5,05	5,24	5,42	5,62	5,43	5,62	-0.6 m/s	5,88
5	Sara Van Hoyweghen	Universiteit Gent	Seniors Femmes	5,58	4,99	5,21	r			5,58	+0.4 m/s	5,69
6	May Lee Cooper	Université de Liège (site de Gembloux)	Seniors Femmes	5,47	5,48	5,30	X	5,27	5,54	5,54	-0.4 m/s	5,77
7	Anne-Dominique Baramoto	Vrije Universiteit Brussel	Seniors Femmes	X	5,14	5,20	5,34	5,23	5,50	5,50	-1.4 m/s	5,98
8	Soraya De Sousa Moreira	Université Libre de Bruxelles	Seniors Femmes	5,34	5,45	5,43	5,20	X	X	5,45	-1.8 m/s	---
9	Prisca Kizito	Odisee Hogeschool	Seniors Femmes	4,95	5,06	5,10				5,10	-0.2 m/s	5,58
10	Febe Ameys	Universiteit Gent	Seniors Femmes	3,71	4,93	5,05				5,05	+0.2 m/s	5,42
11	Sara Vanhalst	Universiteit Gent	Seniors Femmes	4,80	4,98	4,95				4,98	-0.2 m/s	5,45
12	Emeline Cleymans	Université Catholique de Louvain	Seniors Femmes	4,79	4,96	4,86				4,96	-0.3 m/s	5,51
13	Jade Cowie	Inconnue	Juniors Femmes	4,71	4,78	4,69				4,78	-0.4 m/s	4,97
14	Lene Barbé	Universiteit Gent	Juniors Femmes	4,67	4,68	4,52				4,68	-0.7 m/s	4,97
15	Elise Poot	Université Catholique de Louvain	Seniors Femmes	X	4,35	4,65				4,65	+0.1 m/s	5,25
16	Sephora Kana	Ecole Pratiques des Hautes études Commerciales	Seniors Femmes	3,93	3,98	3,71				3,98	+0.1 m/s	---
17	Luna Van De Wiele	Inconnue	Scolaires Femmes	2,78	X	3,68				3,68	-0.8 m/s	4,69
18	Rachel Henno	HE Louvain en Hainaut	Seniors Femmes	3,47	X	X				3,47	-0.2 m/s	---
	Eve Willems	Universiteit Gent	Seniors Femmes	X	X	X				NM		5,54

Hommes – Javelot

#	Nom	Club	Catégorie	Poids	P 1	P 2	P 3	P 4	P 5	P 6	Résul...	OBP
1	Cedric Sorgeloos	Universiteit Gent	Seniors Hommes	800gr	66,71	67,33	62,72	64,41	63,68	62,45	67,33	72,92
2	Victor Suy	Universiteit Gent	Juniors Hommes	800gr	49,67	50,21	47,09	52,22	51,68	46,64	52,22	54,46
3	Lukas Deroo	Universiteit Gent	Seniors Hommes	800gr	49,97	50,33	48,88	44,85	48,88	46,25	50,33	51,63
4	Sven Vereecken	Universiteit Gent	Seniors Hommes	800gr	37,96	38,93	39,65	39,32	40,36	43,70	43,70	---
5	Melvin LEFEBVRE	HE Louvain en Hainaut	Seniors Hommes	800gr	X	32,94	32,85	31,40	37,82	X	37,82	---
6	Ismaël Diamé	HE Léonard de Vinci	Seniors Hommes	800gr	34,50	34,88	36,16	r			36,16	41,01
7	Robin Van Poucke	1 Open meeting - geen student	Masters Hommes	800gr	31,00	35,57	X	31,48	34,78	30,82	35,57	32,64

Dames – Javelot

#	Nom	Club	Catégorie	Poids	P 1	P 2	P 3	P 4	P 5	P 6	Résu...	OBP
1	Cassandre Evans	HE de la Province de Liège	Seniors Femmes	600gr	35,35	36,96	35,24	37,52	36,18	40,20	40,20	45,84
2	Kayla Iven	HE Léonard de Vinci	Seniors Femmes	600gr	39,61	X	37,50	39,96	39,97	39,24	39,97	45,14
3	Fleur Verstraete	Universiteit Gent	Seniors Femmes	600gr	37,59	39,32	39,59	39,48	37,53	38,93	39,59	43,71
4	Caroline Vanhamme	Université Catholique de Louvain	Seniors Femmes	600gr	35,93	38,15	X	36,35	32,52	35,66	38,15	39,78
5	Annelien Beelaert	Universiteit Gent	Seniors Femmes	600gr	34,29	35,53	35,35	34,56	36,69	35,55	36,69	38,84
6	Linde Breban	Universiteit Hasselt	Juniors Femmes	600gr	34,80	35,41	34,07	33,83	35,95	35,74	35,95	38,46
7	Britt Rens	Karel de Grote Hogeschool	Seniors Femmes	600gr	31,64	34,17	X	X	X	33,42	34,17	38,71
8	Lotte Huvenne	Inconnue	Seniors Femmes	600gr	30,54	30,58	31,25	29,37	X	28,60	31,25	36,56
9	Bo Rens	Artesis Plantijn Hogeschool Antwerpen	Seniors Femmes	600gr	X	28,73	X				28,73	29,62
10	Violette Ackaert	Université de Liège (site de Liège)	Seniors Femmes	600gr	23,11	24,28	26,98				26,98	31,15
11	Maëva Defosse	Université de Mons	Seniors Femmes	600gr	26,30	24,47	23,89				26,30	27,70
12	Rune Vierendeels	Hogeschool Gent	Seniors Femmes	600gr	20,54	21,11	20,69				21,11	---
13	Rachel Henno	HE Louvain en Hainaut	Seniors Femmes	600gr	16,05	X	9,90				16,05	---
14	Alessia Kairet	HE Louvain en Hainaut	Seniors Femmes	600gr	X	15,08	13,63				15,08	18,44

Hommes – Disque

#	Nom	Club	Catégorie	P...	P 1	P 2	P 3	P 4	P 5	P 6	Résu...	OBP
1	Andreas De Lathauwer	Odisee Hogeschool	Seniors Hommes	2kg	46,34	48,73	50,70	47,49	48,29	X	50,70	54,31
2	Leander Casteels	Hogeschool Gent	Seniors Hommes	2kg	46,17	46,51	49,00	48,32	47,92	47,66	49,00	48,32
3	Wietse Vander Schelde	Katholieke Universiteit Leuven	Seniors Hommes	2kg	38,99	39,50	42,60	41,79	44,14	X	44,14	41,49
4	Arnaud De Cremer	Universiteit Gent	Seniors Hommes	2kg	42,55	42,43	44,00	X	X	X	44,00	43,57
5	Stan Van wassenhove	Katholieke Universiteit Leuven	Seniors Hommes	2kg	36,07	X	36,88	X	36,55	37,90	37,90	36,33
6	Dylan Volckaert	Universiteit Gent	Seniors Hommes	2kg	X	35,47	36,43	X	35,18	X	36,43	37,10
7	Médéric Zgajewski	Université Catholique de Louvain	Seniors Hommes	2kg	32,31	X	28,77	29,43	33,23	32,33	33,23	32,44
8	Joris Willems	1 Open meeting - geen student	Juniors Hommes	2kg	29,68	33,16	29,67	X	32,87	32,37	33,16	32,22
9	Jelle Daems	Artesis Plantijn Hogeschool Antwerpen	Juniors Hommes	2kg	23,53	31,16	31,91				31,91	27,76
10	Dries Van de Vyver	Inconnue	Seniors Hommes	2kg	28,39	30,46	X				30,46	29,16
11	Riyaad El Amrani	Artesis Plantijn Hogeschool Antwerpen	Seniors Hommes	2kg	20,80	23,22	20,90				23,22	21,22
12	Robin Van Poucke	1 Open meeting - geen student	Masters Hommes	2kg	20,30	20,03	21,96				21,96	21,10
13	François De Radiguès	Université Catholique de Louvain	Seniors Hommes	2kg	19,71	20,64	X				20,64	---
	Victor Gossard	Université Catholique de Louvain	Seniors Hommes	2kg	X	X	X				NM	31,66
	Guillaume De Roover	1 Open meeting - geen student	Seniors Hommes	2kg	X	X	X				NM	39,71
	Tom Vanmarsenille	Hogeschool Gent	Seniors Hommes	2kg	-	-	-				DNS	36,20
	Arnout Schokkaert	Universiteit Gent	Seniors Hommes	2kg	-	-	-				DNS	28,43

Dames – Disque

#	Nom	Club	Catégorie	P...	P 1	P 2	P 3	P 4	P 5	P 6	Résu...	OBP
1	Sena Tay	Inconnue	Juniors Femmes	1kg	45,91	X	X	X	45,55	48,48	48,48	47,51
2	Florence Boeynaems	Artesis Plantijn Hogeschool Antwerpen	Seniors Femmes	1kg	X	41,57	38,51	47,67	48,25	47,52	48,25	46,26
3	Annelien Beelaert	Universiteit Gent	Seniors Femmes	1kg	39,61	39,43	39,09	39,39	40,14	39,97	40,14	41,83
4	Tyra Steur	Universiteit Gent	Seniors Femmes	1kg	37,38	38,24	X	38,43	X	X	38,43	40,85
5	Silke De Lathauwer	1 Open meeting - geen student	Scolaires Femmes	1kg	X	29,92	35,85	33,75	X	X	35,85	37,63
6	Phebe Vanderstraeten	1 Open meeting - geen student	Seniors Femmes	1kg	32,99	32,46	31,94	X	30,05	33,32	33,32	33,81
7	Eva Vanwesemael	Thomas More	Seniors Femmes	1kg	X	X	31,51	32,35	X	X	32,35	33,78
8	Inge Eeckhout	1 Open meeting - geen student	Scolaires Femmes	1kg	31,39	28,06	X	28,93	31,08	25,79	31,39	30,37
9	Helena Oste	Universiteit Gent	Seniors Femmes	1kg	29,94	30,27	29,88				30,27	34,65
10	Jolien Verstraeten	Arteveldehogeschool	Seniors Femmes	1kg	29,11	29,99	28,85				29,99	34,14
11	Lien Swinnen	1 Open meeting - geen student	Cadets Femmes	1kg	29,93	29,47	X				29,93	35,54
12	Elke De Vleeschauwer	1 Open meeting - geen student	Seniors Femmes	1kg	27,89	28,75	X				28,75	33,37
13	Maartje De Temmerman	1 Open meeting - geen student	Scolaires Femmes	1kg	X	X	26,21				26,21	30,89
14	Marion Philippart	Inconnue	Juniors Femmes	1kg	20,52	23,36	X				23,36	---
15	Alessia Kairet	HE Louvain en Hainaut	Seniors Femmes	1kg	22,01	22,86	22,49				22,86	23,05
16	Camille Chauvin	HE Provinciale du Hainaut-Condorcet	Seniors Femmes	1kg	22,53	20,16	20,04				22,53	22,43
17	Thais Flamand	1 Open meeting - geen student	Scolaires Femmes	1kg	22,45	19,58	22,34				22,45	22,77
18	Sarah Eeckhout	Universiteit Gent	Seniors Femmes	1kg	19,96	19,85	X				19,96	20,85

Résultats du Championnat FSUB de Badminton

Arteveldehogeschool
Campus Watersportbaan- Gent

Mercredi 1 mars 2023



denk. doe. word.

Résultats du Championnat FSUB de Badminton

Mercredi 1 mars 2023- GENT

Podiums

Simple Messieurs (1-2-3)

1. Noa Swinnen (UGent)
2. Glaziou Antoine (HELB)
3. Van Britsom Michiel (UGent) & Mas Seppe (ULB Owls)

Simple Dames (1-2-3)

1. Lassaux Clara (ULiège)
2. Henry Karla (ULiège)
3. Van Wouwe Ine (VUB) & Lanckriet Ine (UGent)

Simple Messieurs (4-5-6)

1. Vandenberghe Aaron (KU Leuven)
2. Trappeniers Max (Hogeschool UCLL)
3. Spede Tom (UCLouvain Wolves) & Martens Yoeri (KU Leuven)

Simple Dames (4-5-6)

1. Delforge Rachel (UCLouvain Wolves)
2. Careelmont Sara (UGent)
3. Gekiere Saskia (UGent) & Prooth Irina (KU Leuven)

Double Mixte (1-2-3)

1. Seppe Mas (ULB Owls)
Kaat Van Wouwe (VUB)
2. Stein Bondroit (HoGent)
Evy Taveirne (UGent)
3. Kilaim Panggih Purwoko (KU Leuven)
Soetkin Dewit (KU Leuven)
3. Elias Van Haevermaet (UGent)
Ine Lanckriet (UGent)

Double Mixte (4-5-6)

1. Gust Maekelberg (UGent)
Lotte Bultynck (HoGent)
 2. Liam Bauwens (UC Leuven)
Elke Barbier (KU Leuven)
 3. Wout Maes (KU Leuven)
Sarah Eggermont (HoGent)
 4. Simon Krols (UGent)
Manou Debruyckere (UGent)
 4. Diede Peeters (KU Leuven)
Irina Prooth (KU Leuven)
 4. Martin Budin (UCLouvain Wolves)
Yseult Canautte (UCLouvain Wolves)
-

BK Studenten - CB Etudiants 2023 Gent

Inschrijvingen

Badminton Toernooi Planner - www.toernooi.nl

Nr.	Naam compleet	Instituut	Winnaar single d 123	Winnaar single d 456	Winnaar single h 123	Winnaar single h456	Winnaar mixed dubbels 123	Winnaar dubbel mixed 456
1	Albers Milan	UGent			9			
2	Anil Khurana Divyansh	KU Leuven						
3	Barbier Elke	KU Leuven						2
4	Bauwens Liam	UCLouven			9			2
5	Bertholet Nathan	UCLouvain Wolves				5		
6	Bhatia Jeet Singh	KU Leuven			9			
7	Bondroit Stein	HOGENT					2	
8	Bonte Joachim	UGent						
9	Bossuwé Eloïme	UGENT			9			
10	Bouchez Quentin	UGent			5			
11	Budin Martin	UCLouvain Wolves						
12	Bultynck Lotte	HOGENT						1
13	Canautte Yseult	UCLouvain Wolves						
14	Careelmont Sara	UGENT	2					
15	Cignarella Pauline	ULB OWLS						
16	Daneels Lode	KU Leuven						
17	De Backer Niel	UGENT				9		
18	De Fraye Matthias	UC Leuven						
19	Debruyckere Manou	UGENT						
20	Decubber Sander	AP hogeschool				9		
21	Deleu Wout	KU Leuven - Technologie				9		
22	Delforge Rachel	UCLouvain Wolves	1					
23	Dermaux Wobbe	KULAK				5		
24	Dewit Soetkin	KU Leuven					3	
25	Diederich-Amand Martin	ULB OWLS				5		
26	Eggermont Sarah	HOGENT						3
27	Geenen Youri	Arteveldehogeschool				5		
28	Geerts Lotte	VUB	Ziek					
29	Gekiere Saskia	UGent		3				
30	Glaziou Antoine	HELB			2			
31	Henry Karla	Ullège	2					
32	Ishika Jain	KU Leuven						
33	Jigjinni Sarvesh	KU Leuven				9		
34	Krols Simon	UGent						
35	Lakshminarasimhan Kartik	UGent						
36	Lanckriet Ine	UGent	3				3	
37	Lassaux Clara	Ullège	1					
38	Lejeune Louis	UCLouvain Wolves			5			
39	Liu Qiuping	KU Leuven						1
40	Liu Yongcheng	KU Leuven				9		
41	Maekelberg Gust	UGent			9			1
42	Maes Wout	KU Leuven				9		3
43	Martens Yoeri	KU LEUVEN				3		
44	Martinet Benjamin	ULB						
45	Mas Seppe	ULB			3		1	
46	Nevens Ruben	Arteveldehogeschool						
47	Panggih Purwoko Rifaim	KU Leuven			5		3	
48	Parès Julie	ULB						
49	Peeters Diede	KU Leuven						
50	Pham Timmy	ULB						
51	Pijl Jonathan	KU Leuven				9		
52	Prooth Irina	KU Leuven sint Lucas		3				
53	Rongione Charles	UCLouvain Wolves						
54	Sabareesh Murugan	KU Leuven						
55	Soenen Wannes	UGent			9			
56	Spede Tom	UCLouvain Wolves				3		
57	Struvay Ben	UCLouvain Wolves				9		
58	Swinen Niel	KU LEUVEN						
59	Swinen Noa	UGent			1			
60	Taveirne Evy	UGent					2	
61	Trappeniers Max	Hogeschool UCLL-heverl				2		
62	Van Britsom Mare	UGent						
63	Van Britsom Michiel	UGent			3			
64	Van Den Berg Lobke	KU LEUVEN						
65	Van Gysegem Thomas	Arteveldehogeschool			5			
66	Van Haevermaet Elias	UGent			9		3	
67	Van Parys Mirthe	UGent						
68	Van Wouwe Ine	VUB	3					
69	Van Wouwe Kaat	VUB					1	
70	Vandenberghie Aaron	KU Leuven				1		
71	Venkataramana Rishikesan	KU Leuven						
72	Wenzlawski Lindsey	KdG Hogeschool	Ziek					
73	Zhang Rui	UGent						

Résultats compétition

Simple Messieurs (1-2-3)

MS 1-2-3

	1e Ronde	Kwart	Halve	Finale	Winnaar
1	Louls Lejeune [1] <i>UCL W</i>	Louls Lejeune [1]			
2	Bye		Michiel Van Britsom		
3	Michiel Van Britsom <i>UGENT</i>	Michiel Van Britsom	17-21 21-12 21-13		
4	Milan Albers <i>UGENT</i>	25-23 21-12		Antoine Glaziou [4]	
5	Antoine Glaziou [4] <i>HELB</i>	Antoine Glaziou [4]		17-21 21-13 21-17	
6	Wannes Soenen <i>UGENT</i>	21-19 21-18	Antoine Glaziou [4]		
7	Quentin Bouchez [5] <i>UGENT</i>	Quentin Bouchez [5]	21-17 19-21 21-14		
8	Jeet Singh Bhatia <i>KUL</i>	19-21 21-12 21-19			Noa Swinnen [3]
9	Gust Maekelberg <i>UGENT</i>				20-22 21-8 21-6
10	<i>ARTEVELDE HG</i> Thomas Van Gysegem	Thomas Van Gysegem 21-17 17-21 21-18			
11	Liam Bauwens <i>UC LEUVEN</i>		Noa Swinnen [3]		
12	Noa Swinnen [3] <i>UGENT</i>	19-21 21-16 21-10	21-5 21-15		
13	Elias Van Haevermaet <i>UGENT</i>			Noa Swinnen [3]	
14	<i>KUL</i> Kilaim Panggih Purwoko	Kilaim Panggih Purwoko 21-14 17-21 21-13		21-8 21-18	
15	Seppe Mas <i>ULB OWLS</i>		Seppe Mas		
16	Eloime Bossuwé [2] <i>UGENT</i>	21-15 21-15	21-15 21-17		

Simple Dames (1-2-3)

WS 1-2-3 - Groep A

	1	2	3
1 Clara Lassaux [1]		21-12 21-5 Gewonnen	
2 Kaat Van Wouwe	12-21 5-21 Verloren		
3 Bye			

Ulg (lg)
VUB

Poulestand van WS 1-2-3 - Groep A

	Punten	Gespeeld	Wedstrijden	Games	Punten
1 Clara Lassaux	1	1	1 - 0	2 - 0	42 - 17
2 Kaat Van Wouwe	0	1	0 - 1	0 - 2	17 - 42

WS 1-2-3 - Groep B

	1	2	3
1 Karla Henry [2]		21-17 21-23 21-9 Gewonnen	21-12 21-10 Gewonnen
2 Soetkin Dewit	17-21 23-21 9-21 Verloren		20-22 28-26 21-16 Gewonnen
3 Lobke Van Den Berg	12-21 10-21 Verloren	22-20 26-28 16-21 Verloren	

Poulestand van WS 1-2-3 - Groep B

	Punten	Gespeeld	Wedstrijden	Games	Punten
1 Karla Henry	2	2	2 - 0	4 - 1	105 - 71
2 Soetkin Dewit	1	2	1 - 1	3 - 3	118 - 127
3 Lobke Van Den Berg	0	2	0 - 2	1 - 4	86 - 111

WS 1-2-3 - Groep C

	1	2	3
1 Lotte Geerts [3, WDN]		Walkover Verloren	Walkover Verloren
2 Evy Taveirne	Walkover Gewonnen		7-21 12-21 Verloren
3 Ine Van Wouwe	Walkover Gewonnen	21-7 21-12 Gewonnen	

Poulestand van WS 1-2-3 - Groep C

	Punten	Gespeeld	Wedstrijden	Games	Punten
1 Ine Van Wouwe	1	1	1 - 0	2 - 0	42 - 19
2 Evy Taveirne	0	1	0 - 1	0 - 2	19 - 42
3 Lotte Geerts	0	0	0 - 0	0 - 0	0 - 0

WS 1-2-3 - Groep D

	1	2	3
1 Ine Lanckriet [4]		21-12 21-14 Gewonnen	21-13 21-14 Gewonnen
2 Mirthe Van Parys	12-21 14-21 Verloren		21-15 21-14 Gewonnen
3 Mare Van Britsom	13-21 14-21 Verloren	15-21 14-21 Verloren	

Poulestand van WS 1-2-3 - Groep D

	Punten	Gespeeld	Wedstrijden	Games	Punten
1 Ine Lanckriet	2	2	2 - 0	4 - 0	84 - 53
2 Mirthe Van Parys	1	2	1 - 1	2 - 2	68 - 71
3 Mare Van Britsom	0	2	0 - 2	0 - 4	56 - 84

Tableau final Simple Dames (1-2-3)

WS 1-2-3

	Halve	Finale	Winnaar
1 Clara Lassaux		Clara Lassaux	
2 Ine Lanckriet		21-18 21-17	
3 Ine Van Wouwe			Clara Lassaux 21-12 21-12
4 Karla Henry		Karla Henry 21-12 21-10	

Ulg (lg)
KUL
KUL

VUB
UGENT
VUB

UGENT
UGENT
UGENT

Simple Messieurs (4-5-6)

MS 4-5-6

	1e Ronde	2e Ronde	Kwart	Halve	Finale	Winnaar
1	Qiuping Liu [1] KUL					
2	Yongcheng Liu KUL	Yongcheng Liu 21-13 21-8				
3	Diede Peeters KUL		Yoeri Martens 18-21 21-14 21-14			
4	Yoeri Martens KUL	Yoeri Martens 19-21 23-21 21-13			Yoeri Martens 21-13 21-16	
5	Rishikesan Venkataramana KUL	Niel De Backer 21-9 21-18				
6	Niel De Backer UGENT		Wobbe Dermaux 21-13 21-15			
7	Martin Budin UCL W	Wobbe Dermaux 27-25 21-16				
8	Wobbe Dermaux KULAK					
9	Jonathan Pijl [3/4] KUL	Jonathan Pijl [3/4] 21-15 21-18			Aaron Vandenberghe 24-22 13-21 21-13	
10	Lode Daneels KUL		Nathan Bertholet 8-21 21-15 24-22			
11	Kartik Lakshminarasimhan UGENT	Nathan Bertholet 21-17 19-21 21-12			Aaron Vandenberghe 21-10 21-11	
12	Nathan Bertholet UCL W					
13	Sander Decubber AP	Sander Decubber 21-14 21-17				
14	Simon Kruls UGENT		Aaron Vandenberghe 21-10 21-12			
15	Aaron Vandenberghe KUL	Aaron Vandenberghe 19-21 21-15 21-16				
16	Charles Rongione UCL W				Aaron Vandenberghe 21-10 11-21 21-16	
17	Wout Deleu KUL	Wout Deleu 21-17 21-19				
18	Rui Zhang UGENT		Youri Geenen 21-19 21-16			
19	Divyansh Anil Khurana KUL	Youri Geenen 21-10 21-17				
20	Youri Geenen ARTEVELDE				Max Trappeniers [3/4] 21-12 17-21 21-15	
21	Wout Maes KUL	Wout Maes 22-24 21-12 21-14				
22	Benjamin Martinet ULB		Max Trappeniers [3/4] 21-13 21-9			
23	Mattias De Fraye UC LEUVEN	Max Trappeniers [3/4] 21-12 21-8				
24	Max Trappeniers [3/4] UCL LEUVEN				Max Trappeniers [3/4] 21-12 20-22 21-10	
25	Sarvesh Jigjinni KUL	Sarvesh Jigjinni 21-12 16-21 23-21				
26	Joachim Borte UGENT		Martin Diederich-Amand 21-13 11-21 21-13			
27	Martin Diederich-Amand ULB	Martin Diederich-Amand 21-16 14-21 21-15				
28	Ruben Nevens ARTEVELDE				Tom Spede [2] 21-19 21-11	
29	Timmy Pham ULB	Ben Struvay 19-21 21-14 21-17				
30	Ben Struvay UCL W		Tom Spede [2] 21-16 21-17			
31	Niel Swinnen KUL	Tom Spede [2] 18-21 21-16 21-16				
32	Tom Spede [2] UCL W					

Simple Dames (4-5-6)

WS 4-5-6 - Groep A

	1	2	3
1 Irina Prooth [1]		18-21 21-19 21-13 Gewonnen	
2 Julie Parès	21-18 19-21 13-21 Verloren		
3 Bye			

Poulestand van WS 4-5-6 - Groep A

	Punten	Gespeeld	Wedstrijden	Games	Punten
1 Irina Prooth	1	1	1 - 0	2 - 1	60 - 53
2 Julie Parès	0	1	0 - 1	1 - 2	53 - 60

WS 4-5-6 - Groep B

	1	2	3
1 Saskia Gekiere [2]		21-11 21-15 Gewonnen	21-18 21-13 Gewonnen
2 Elke Barbier	11-21 15-21 Verloren		21-10 16-21 18-21 Verloren
3 Manou Debruyckere	18-21 13-21 Verloren	10-21 21-16 21-18 Gewonnen	

Poulestand van WS 4-5-6 - Groep B

	Punten	Gespeeld	Wedstrijden	Games	Punten
1 Saskia Gekiere	2	2	2 - 0	4 - 0	84 - 57
2 Manou Debruyckere	1	2	1 - 1	2 - 3	83 - 97
3 Elke Barbier	0	2	0 - 2	1 - 4	81 - 94

WS 4-5-6 - Groep C

	1	2	3
1 Rachel Delforge [3]		21-18 21-12 Gewonnen	Walkover Gewonnen
2 Pauline Cignarella	18-21 12-21 Verloren		Walkover Gewonnen
3 Lindsey Wenzlawski [WDN]	Walkover Verloren	Walkover Verloren	

Poulestand van WS 4-5-6 - Groep C

	Punten	Gespeeld	Wedstrijden	Games	Punten
1 Rachel Delforge	1	1	1 - 0	2 - 0	42 - 30
2 Pauline Cignarella	0	1	0 - 1	0 - 2	30 - 42
3 Lindsey Wenzlawski	0	0	0 - 0	0 - 0	0 - 0

WS 4-5-6 - Groep D

	1	2	3
1 Sara Careelmont [4]		21-11 21-10 Gewonnen	21-11 21-11 Gewonnen
2 Jain Ishka	11-21 10-21 Verloren		21-18 19-21 21-12 Gewonnen
3 Sarah Eggermont	11-21 11-21 Verloren	18-21 21-19 12-21 Verloren	

Poulestand van WS 4-5-6 - Groep D

	Punten	Gespeeld	Wedstrijden	Games	Punten
1 Sara Careelmont	2	2	2 - 0	4 - 0	84 - 43
2 Jain Ishka	1	2	1 - 1	2 - 3	82 - 93
3 Sarah Eggermont	0	2	0 - 2	1 - 4	73 - 103

Tableau final Simple Dames (4-5-6)

WS 4-5-6

	Halve	Finale	Winnaar
1 Irina Prooth			
2 Sara Careelmont		Sara Careelmont 21-11 21-12	
3 Rachel Delforge			Rachel Delforge 17-21 21-13 21-15
4 Saskia Gekiere		Rachel Delforge 21-17 21-19	

KUL

ULB OWLS

UGENT

KUL

UGENT

UCL W

ULB OWLS

KDG

UGENT

KUL

HO GENT

Double Mixte (1-2-3)

KUL
UGENT

XD 1-2-3 - Groep A		1	2	3
1	Kilain Panggih Purwoko (1) Soetkin Dewit		19-21 21-12 21-14 Gewonnen	
2	Milan Albers Mirthe Van Parys	21-19 12-21 14-21 Verloren		
3	Bye			

Poulestand van XD 1-2-3 - Groep A

	Punten	Gespeeld	Wedstrijden	Games	Punten
1 Kilain Panggih Purwoko Soetkin Dewit	1	1	1 - 0	2 - 1	61 - 47
2 Milan Albers Mirthe Van Parys	0	1	0 - 1	1 - 2	47 - 61

UGENT
UGENT
UGENT

XD 1-2-3 - Groep B		1	2	3
1	Wannes Soenen (2) Mare Van Britsom		21-18 19-21 22-20 Gewonnen	9-21 17-21 Verloren
2	Eloime Bossuwé Sara Careelmont	18-21 21-19 20-22 Verloren		18-21 18-21 Verloren
3	Elias Van Haevermaet Ine Lanckriet	21-9 21-17 Gewonnen	21-18 21-18 Gewonnen	

Poulestand van XD 1-2-3 - Groep B

	Punten	Gespeeld	Wedstrijden	Games	Punten
1 Elias Van Haevermaet Ine Lanckriet	2	2	2 - 0	4 - 0	84 - 62
2 Wannes Soenen Mare Van Britsom	1	2	1 - 1	2 - 3	88 - 101
3 Eloime Bossuwé Sara Careelmont	0	2	0 - 2	1 - 4	95 - 104

UGENT
KUL
HO GENT
UGENT
UCL W

XD 1-2-3 - Groep C		1	2	3
1	Quentin Bouchez (3) Lobke Van Den Berg		19-21 18-21 Verloren	19-21 19-21 Verloren
2	Stein Bondroit Evy Taveirne	21-19 21-18 Gewonnen		21-19 22-20 Gewonnen
3	Louis Lejeune Rachel Delforge	21-19 21-19 Gewonnen	19-21 20-22 Verloren	

Poulestand van XD 1-2-3 - Groep C

	Punten	Gespeeld	Wedstrijden	Games	Punten
1 Stein Bondroit Evy Taveirne	2	2	2 - 0	4 - 0	85 - 76
2 Louis Lejeune Rachel Delforge	1	2	1 - 1	2 - 2	81 - 81
3 Quentin Bouchez Lobke Van Den Berg	0	2	0 - 2	0 - 4	75 - 84

ULB
VUB
ARTEVELDE
VUB
UGENT
VUB

XD 1-2-3 - Groep D		1	2	3
1	Seppe Mas (4) Kaat Van Wouwe		21-16 21-19 Gewonnen	Walkover Gewonnen
2	Thomas Van Gyssegem Ine Van Wouwe	16-21 19-21 Verloren		Walkover Gewonnen
3	Michiel Van Britsom (WDM) Lotte Geerts	Walkover Verloren	Walkover Verloren	

Poulestand van XD 1-2-3 - Groep D

	Punten	Gespeeld	Wedstrijden	Games	Punten
1 Seppe Mas Kaat Van Wouwe	1	1	1 - 0	2 - 0	42 - 35
2 Thomas Van Gyssegem Ine Van Wouwe	0	1	0 - 1	0 - 2	35 - 42
3 Michiel Van Britsom Lotte Geerts	0	0	0 - 0	0 - 0	0 - 0

Tableau final Double Mixte (1-2-3)

XD 1-2-3

	Halve	Finale	Winnaar
1	Kilain Panggih Purwoko Soetkin Dewit	Seppe Mas Kaat Van Wouwe	Seppe Mas Kaat Van Wouwe
2	Seppe Mas Kaat Van Wouwe	22-20 21-17	Seppe Mas Kaat Van Wouwe
3	Stein Bondroit Evy Taveirne	Stein Bondroit Evy Taveirne	19-21 21-18 21-19
4	Elias Van Haevermaet Ine Lanckriet	21-18 21-16	

Double Mixte (4-5-6)

XD 4-5-6 - Groep A

	1	2	3
1 Liam Bauwens [1] Elke Barblier		21-13 21-9 Gewonnen	21-6 21-14 Gewonnen
2 Murugan Sabareesh Jain Ishika	13-21 9-21 Verloren		20-22 17-21 Verloren
3 Simon Kroels Manou Debruyckere	6-21 14-21 Verloren	22-20 21-17 Gewonnen	

Poulestand van XD 4-5-6 - Groep A

	Punten	Gespeeld	Wedstrijden	Games	Punten
1 Liam Bauwens Elke Barblier	2	2	2 - 0	4 - 0	84 - 42
2 Simon Kroels Manou Debruyckere	1	2	1 - 1	2 - 2	63 - 79
3 Murugan Sabareesh Jain Ishika	0	2	0 - 2	0 - 4	59 - 85

XD 4-5-6 - Groep B

	1	2	3
1 Martin Budin [2] Yseult Canautte		21-15 16-21 17-21 Verloren	19-21 21-19 21-16 Gewonnen
2 Wout Maes Sarah Eggermont	15-21 21-16 21-17 Gewonnen		21-19 10-21 21-18 Gewonnen
3 Benjamin Martinet Julie Parès	21-19 19-21 16-21 Verloren	19-21 21-10 18-21 Verloren	

Poulestand van XD 4-5-6 - Groep B

	Punten	Gespeeld	Wedstrijden	Games	Punten
1 Wout Maes Sarah Eggermont	2	2	2 - 0	4 - 2	109 - 112
2 Martin Budin Yseult Canautte	1	2	1 - 1	3 - 3	115 - 113
3 Benjamin Martinet Julie Parès	0	2	0 - 2	2 - 4	114 - 113

XD 4-5-6 - Groep C

	1	2	3	4
1 Gust Maekelberg [3] Lotte Bultynck		21-15 21-11 Gewonnen	21-11 21-7 Gewonnen	Walkover Gewonnen
2 Diede Peeters Irina Prooth	15-21 11-21 Verloren		21-19 15-21 23-21 Gewonnen	Walkover Gewonnen
3 Martin Diederich-Amand Pauline Cignarella	11-21 7-21 Verloren	19-21 21-15 21-23 Verloren		Walkover Gewonnen
4 Sander Decubber [WDN] Lindsey Wenzlowski	Walkover Verloren	Walkover Verloren	Walkover Verloren	

Poulestand van XD 4-5-6 - Groep C

	Punten	Gespeeld	Wedstrijden	Games	Punten
1 Gust Maekelberg Lotte Bultynck	2	2	2 - 0	4 - 0	84 - 44
2 Diede Peeters Irina Prooth	1	2	1 - 1	2 - 3	85 - 103
3 Martin Diederich-Amand Pauline Cignarella	0	2	0 - 2	1 - 4	79 - 101
4 Sander Decubber Lindsey Wenzlowski	0	0	0 - 0	0 - 0	0 - 0

Tableau final Double Mixte (4-5-6)

XD 4-5-6

	Halve	Finale	Winnaar
1	Liam Bauwens Elke Barblier	Liam Bauwens Elke Barblier	Gust Maekelberg Lotte Bultynck 21-16 15-21 23-21
2	Bye		
3	Gust Maekelberg Lotte Bultynck	Gust Maekelberg Lotte Bultynck	
4	Wout Maes Sarah Eggermont	21-19 21-11	

OC LEUVEN
KUL
KUL
KUL
UGENT

OC W
OC W
KUL
HO GENT
ULB OWLS
ULB OWLS

UGENT
HO GENT
KUL
OWLS
AP
KDG

Résultats du Championnat FSUB de Course d'Orientation

Lommel

(Thomas More)

Dimanche 12 février 2023



www.kempen-ol.be



THOMAS
MORE



BSK ORIËNTATIELOPEN – 12 FEBRUARI 2023 – LOMMELSE SAHARA

BUSF DAMES 7010m (11)						[H:]M:S	min/km	
1.		Ems DE SMUL	BEL	D21	KU Leuven	44:06	6'17"	
2.		Julia KREKELS	BEL	D21	KU Leuven	46:01	6'34"	+1:55
3.		Sarah ROOMAN	BEL	D-18	KU Leuven	46:27	6'38"	+2:21
4.		Claudia ROOMAN	BEL	D21	UGENT	49:19	7'02"	+5:13
5.		Laurence DEFRAIGNE	BEL	D21	UCL Louvain	55:00	7'51"	+10:54
6.		Gaëlle FRONHOFFS	BEL	D21	VUB	56:00	7'59"	+11:54
7.		Emma WILLEMSSENS	BEL	D21	ULiège	1:02:37	8'56"	+18:31
8.		Lisa ELSEN	BEL	D21	KU Leuven	1:24:25	12'03"	+40:19
9.		Mathilde DE HEMPTINNE	BEL	D21	UCL Louvain	2:00:13	17'09"	+1:16:07
NCL		Emma FAUVILLION	BEL	D21	HELHa			
NCL		Léonie PFISTER	BEL	D-20	HELHa			





BUSF HEREN  8830m (18)						[H:]M:S	min/km		
1.		Liam THIELS		BEL	H21	KU Leuven	44:38	5'03"	
2.		Simon KREKELS		BEL	H21	KU Leuven	46:05	5'13"	+1:27
3.		Rune DE CLERCQ		BEL	H-18	UGENT	49:53	5'39"	+5:15
4.		Corneel CASIER		BEL	H21	UGENT	50:47	5'45"	+6:09
5.		Willem BAKELANTS		BEL	H-20	KU Leuven	51:27	5'50"	+6:49
6.		Cédric AMERIJCKX		BEL	H21	UCL Louvain	52:29	5'57"	+7:51
7.		Joris SMET		BEL	H-20	UGENT	55:32	6'17"	+10:54
8.		François DE RADIGUES		BEL	H21	UCL Louvain	1:09:57	7'55"	+25:19
9.		Tibo GILLET		BEL	H21	KU Leuven	1:10:16	7'57"	+25:38
10.		Thibe VAN ZEEBROECK		BEL	H21	UCL Louvain	1:11:03	8'03"	+26:25
11.		Wolf DE MITS		BEL	H-20	UGENT	1:14:06	8'24"	+29:28
12.		Thiran GREGOIRE		BEL	H21	HEVinci	1:17:01	8'43"	+32:23
13.		Noam LEMY STORME		BEL	H-20	UCL Louvain	1:20:52	9'09"	+36:14
14.		Thomas VAN DYCK		BEL	H21	UCL Louvain	1:22:55	9'23"	+38:17
15.		Colin FERRIER		BEL	H21	UCL Louvain	1:25:10	9'39"	+40:32
16.		Pierre FRYs		BEL	H21	UCL Louvain	1:33:03	10'32"	+48:25
NCL		Adrien MORTIER		BEL	H21	HELHa			

NCL		Alexandre GROUX		BEL	H21	HELHa			
-----	---	-----------------	--	-----	-----	-------	--	--	--

Dames:08 2180m (6)

						[H:]M:S	min/km		
1.		Ninthe WOLLES		BEL	D-12	hamok	16:43	7'40"	
2.		Noore SELS		BEL	D-12	hamok	20:29	9'24"	+3:46
3.		Merel KEYSERS		BEL	D-10	K.O.L.	26:00	11'56"	+9:17
4.		Mirjam CALLAERT		BEL	D45	TROL	33:24	15'19"	+16:41
--		Marie QUISTHOUDT		BEL	D70	Omega	29:59	13'45"	+13:16
--		Jelinka VAN DAMME		BEL	D21	KU Leuven	33:48	15'30"	+17:05

Heren:08 2180m (5)

						[H:]M:S	min/km		
1.		Jens DEFERM		BEL	H-10	hamok	15:41	7'12"	
2.		Rune SELS		BEL	H-12	hamok	15:43	7'13"	+0:02
3.		Witse BOECKX		BEL	H-12	Omega	30:19	13'54"	+14:38
--		Peter GEBOERS		BEL	H65	K.O.L.	24:33	11'16"	+8:52
--		Mathias VANWINKEL		BEL	H21	KU Leuven	33:47	15'30"	+18:06

Résultats du Championnat FSUB de Course d'Orientation

Malonne

(Thor et Pégase)

Samedi 22 avril 2023













Fédération Régionale des Sports d'Orientation

rue de la Pêcherie, 180
1180 Bruxelles
02 640 69 22
jnd@frso.be

www.frso.be







Résultats Course d'Orientation urbaine FSUB du Samedi 22/04/23

U - Men 2400m 85m (8)

					[H:]M:S	min/km	
1.	 Simon KREKELS 	BEL	H21	KU Leuven	14:17	5'57"	
2.	 Antoine MATTART	BEL	H-20	Haute Ecole de la Province de Liège	15:00	6'15"	+0:43
3.	 Rune DE CLERCQ 	BEL	H-18	Universiteit Gent	15:13	6'20"	+0:56
4.	 Marcell SZABO	HUN	H21	UCLouvain	16:28	6'52"	+2:11
5.	 Nicolas TRIFFAUX	BEL	H21	UCLouvain	16:38	6'56"	+2:21
6.	 François DE RADIGUES	BEL	H21	UCLouvain	18:54	7'53"	+4:37
7.	 Thibe VAN ZEEBROECK	BEL	H21	UCLouvain	25:16	10'32"	+10:59
NCL	 Willem BAKELANTS	BEL	H-20	KU Leuven			

[Top](#)

U - Women 2100m 75m (7)

					[H:]M:S	min/km	
1.	 Marine SILLIEN	BEL	D21	UCLouvain	14:45	7'01"	
2.	 Ems DE SMUL	BEL	D21	KU Leuven	15:50	7'32"	+1:05
3.	 Julia KREKELS	BEL	D21	KU Leuven	15:55	7'35"	+1:10
4.	 Sarah ROOMAN	BEL	D-18	KU Leuven	16:04	7'39"	+1:19
5.	 Claudia ROOMAN	BEL	D21	Universiteit Gent	17:23	8'17"	+2:38
6.	 Laurence DEFRAIGNE	BEL	D21	UCLouvain	18:38	8'52"	+3:53
7.	 Salomé SINTY	BEL	D21	UCLouvain	25:04	11'56"	+10:19

Résultats du Championnat FSUB
de Cross Country
Braine l'Alleud
Samedi 12 novembre 2022





Toitures Plasman - 47e G.P. Gaston Reiff de Cross-country - Braine-l'Alleud

RESULTATS

Samedi 12 Novembre 2022

Parc du Cheneau

Braine-l'Alleud

Un grand merci à l'Administration Communale et à la Police de Braine l Alleud, à « Toitures Plasman » sponsor principal de l'évènement, à InBW, à la Province du Brabant Wallon, à AG Insurance, à tous les sponsors de l'USBW, à tous les bénévoles sans qui l'organisation ne pourrait exister ainsi qu'à tous les athlètes présents.

Dank aan de Nederlandstalige clubs voor hun aanwezigheid en deelname



Cross Court Dames- Résultats (1.470 m)

<u>Rang</u>	<u>Numero de dossard</u>	<u>Nom</u>	<u>Cercle</u>
1	2163	Collin, Amélie (HENALLUX)	UAC
2	2359	Kouassi Aka, Oceane (ULB Owls)	OSGA
3	2586	Bonin, Clarisse (HE Vinci)	WS
4	595	Troussart, Noémie (HENALLUX)	SMAC
5	574	Francois, Eva (HELHA)	OSGA
6	184	Haouari, Farah (He Vinci)	NA
7	2255	Mazzoli, Marie (UCL Wolves)	DAMP
8	570	Gonne, Sarah (UMONS Dragons)	OSGA
9	178	Evrard, Jeanne (HE Vinci)	NA
10	164	Dassonville, Nina (HE Vinci)	NA
11	225	Surquin, Mégane (He Vinci)	NA
12	154	Boubnane, Amel (HE Vinci)	NA
13	152	Boquet, Alienor (HE Vinci)	NA
14	161	Capelle, Marie (HE Vinci)	NA
15	170	Doehaerd, Yula (HE Vinci)	NA
16	196	Lemaitre, Eva (HE Vinci)	NA
17	158	Bruyere, Léonie (HE Vinci)	NA
18	167	Dekeyzer, Tiffany (He Vinci)	NA
19	171	Dorchy, Louise (HE Vinci)	NA
20	229	Tomas Delhaye, Valentina (HE Vinci)	NA
21	140	Aarab, Salma (HE Vinci)	NA
22	172	Dubois, Elise (HE Vinci)	NA
23	182	Guclu, Selenay (He Vinci)	NA
24	192	Kyzilas, Helena (He Vinci)	NA
25	228	Thomas, Elisa (He Vinci)	NA
26	188	Hourman, Louise (He Vinci)	NA
27	232	Van Wynsberghe, Laly (HE Vinci)	NA
28	207	Mpimpikas, Christina (HE Vinci)	NA
29	160	Buys, Estelle (HE Vinci)	NA
30	186	Hoang, Anh-Christina (He Vinci)	NA
31	189	Hudzik, Lea (He Vinci)	NA
32	240	Zimmermann, Nina (HE Vinci)	NA

Cross Court Hommes- Résultats (2.300 m)

<u>Rang</u>	<u>Numéro de dossard</u>	<u>Nom</u>	<u>Cercle</u>
1	3329	Delvoie, Maxime (UCL Wolves)	CSDY
2	3629	Dardenne, Théodore (HERS)	BBS
3	831	Lelievre, Thibault (UCL Wolves)	WS
4	3031	Simon, Edouard (UCL Wolves)	SMAC
5	1806	Lalmand, Donald	CSF
6	854	Noppe, Arthur (HE Vinci)	USBW
7	2800	Mathurin, Aurian (HS West-Vlaanderen)	GOSP
8	2920	Van Hammee, Simon (He Vinci)	RIWA
9	622	Hecquet, Lilian (HEPH Condorcet)	OSGA
10	630	Mullens, Victor (UCL Wolves)	HUY
11	657	Turpyn, Edgard (He Vinci)	JSMC
12	243	Benouda, Nawfel (He Vinci)	NA
13	190	Ingels, Tanguy (He Vinci)	NA
14	620	Vanthournout, Camile (HELHA)	OSGA
15	195	Legrand, Benjamin (HE Vinci)	NA
16	150	Bobiana, Melvin (HE Vinci)	NA
17	177	Ettaf, Amine (HE Vinci)	NA
18	264	Muneza, Bienvenu (HELMO)	NA
19	199	Lespagne, Sasha (He Vinci)	NA
20	226	Tarfi, Amin (HE Vinci)	NA
21	156	Bourguignon, Marius (HE Vinci)	NA
22	173	El Assiri, Souleimane (HE Vinci)	NA
23	266	Peronnet, Mathias (HELHA)	NA
24	151	Boon, Thomas (HE Vinci)	NA
25	181	Fievet, Samuel (HE Vinci)	NA
26	238	Waldbillig, Mathieu (HE Vinci)	NA
27	201	Looze, Thomas (He Vinci)	NA
28	235	Verwilghen, Antoine (HE Vinci)	NA
29	165	De Smet, Grégory (HE Vinci)	NA
30	185	Herlem, Thomas (He Vinci)	NA
31	231	Vanabelle, Julien (He Vinci)	NA
32	227	Thirionet, Robinson (He Vinci)	NA
33	159	Butera, Enzo (HE Vinci)	NA
34	200	Lodomez, Guillaume (He Vinci)	NA
35	203	Mees, Jean (He Vinci)	NA
36	249	de Neuville, Emmanuel (HO Gent)	NA
37	144	Antoniou, Athanassios (HE Vinci)	NA
38	604	Thys, Maxime (HE2B)	ACLO
39	146	Belchior, Noé (HE Vinci)	NA
40	222	Sekik, Mohamed (HE Vinci)	NA
41	219	Russi, Matteo (HE Vinci)	NA
42	214	Pauwels, Sacha (HE Vinci)	NA
43	147	Bellante, Gaeta (HE Vinci)	NA
44	205	Milandu Mpezo, Yoshiya (He Vinci)	NA
45	223	Simon, Alexandre (He Vinci)	NA
46	143	Alexandre, James (HE Vinci)	NA

47	157	Boutekhrit, Mohammed (He Vinci)	NA
48	236	Vivier, Pol (HE Vinci)	NA
49	217	Riestra, Raphael (HE Vinci)	NA
50	204	Merepesa, Brendon (He Vinci)	NA
51	215	Ramazani, Geoffrey (HE Vinci)	NA
52	198	Lepre Capron, Ugo (He Vinci)	NA
53	209	Musikami Ntububa, Victorin (He Vinci)	NA
54	224	Spillebeem, Clement (HE Vinci)	NA
55	197	Leonardo, Hugo (He Vinci)	NA
56	187	Holleville, Nicolas (He Vinvi)	NA
57	194	Langlet, Max (HE Vinci)	NA
58	230	Turneer, Aurélien (He Vinci)	NA
59	168	Desmedt, Natan (HE Vinci)	NA
60	166	Defrecheux, Arthur (He Vinci)	NA
61	212	Nimpa, Etienne (He Vinci)	NA
62	162	Cudicio, Matteo (HE Vinci)	NA
63	237	Vreux, Noan (HE Vinci)	NA
64	163	Czerwinski, Valentin (HE Vinci)	NA
65	169	Di Paolo, Luigi (HE Vinci)	NA
66	175	El Merzouki, Ilias (HE Vinci)	NA
67	145	Bakioui, Mehdi (HE Vinci)	NA
68	221	Sakindi, Emmanuel-Celestin (He Vinci)	NA
69	210	Mylle, Louis (HE Vinci)	NA
70	216	Renard, Gilles (HE Vinci)	NA
71	183	Hadit, Mustapha (HE Vinci)	NA
72	218	Rorsvort, David (He Vinci)	NA
73	174	El Faguirich, Khalil (HE Vinci)	NA
74	180	Feyereisen, Julien (He Vinci)	NA
75	142	Agustin, Niko (HE Vinci)	NA
76	202	Lovenweent, Maxim (HE Vinci)	NA
77	149	Berisha, Youssouf (HE Vinci)	NA
78	176	Ernotte, Antoine (HE Vinci)	NA
79	155	Boumghait, Youssef (HE Vinci)	NA
80	233	Vanden Brempt, Matthieu (He Vinci)	NA
81	208	Muhadri, Driton (He Vinci)	NA
82	206	Minichello, Carmelo (He Vinci)	NA
83	153	Boualala Zaouagai, Hamza (HE Vinci)	NA

Cross Long Dames- Résultats (5.300 m)

<u>Rang</u>	<u>Numero de dossard</u>	<u>Nom</u>	<u>Cercle</u>
1	665	Laloux, Sophie (USLB Dragons)	CSDY
2	227	Pauwelyn, Yana (KUL)	OEH
3	2480	Vancolen, Elisa (UCL Wolves)	CSDY
4	596	Lombard, Maximilienne (ULB Owls)	OSGA
5	2401	Suermondt, Lili (HE Vinci)	CSDY
6	263	Martin, Ophélie (UCL Wolves)	NA
7	254	Ernst, Ilaria (UCL Wolves)	NA
8	265	Nierenberger, Heloise (UCL Wolves)	NA
9	1140	Van Breusegem, Nikita (UGENT)	ZA
10	268	Sneessens, Eve-Marie (HELHa)	NA
11	2620	Bournel, Lou (HE Vinci)	WS

Cross Long Hommes- Résultats (6.900 m)

<u>Rang</u>	<u>Numéro de dossard</u>	<u>Nom</u>	<u>Cercle</u>
1	1432	Simons, Wouter (HS PXL)	ATLA
2	680	Oldenhove, Martin (UCL Wolves)	CSDY
3	273	Van der Kaa, Thomas (UCL Wolves)	NA
4	3528	Vancolen, Pierre (UCL Wolves)	CSDY
5	3062	Martin, Simon (UCL Wolves)	RIWA
6	2891	Delvoie, Basile (UCL Wolves)	CSDY
7	619	Lengelé, Antoine (Umons Dragons)	OSGA
8	272	Van Camp, Siemen (KUL)	NA
9	834	Vandermunter, Bastien (HE2B)	USBW
10	2876	Willems, Oskar (UCL Wolves)	RIWA
11	1749	Duyckaerts, Louis	CSF
12	3657	Lechat, Antoine (UCL Wolves)	MOHA
13	270	Thiebaut, Lucien (HERS)	NA
14	2895	Heroufosse, Baptiste (UCL Wolves)	CSDY
15	247	Cherouvrier, Théo (HE Vinci)	NA
16	259	Jullien, Justin (UCL Wolves)	NA
17	2936	Hautefin, Silvain (UCL Wolves)	CABW
18	3278	Snyers, Charles (VUB)	WS
19	2896	Houssiere, Pierre (UCL Wolves)	CSDY
20	241	Agrell, Oscar (UCL Wolves)	NA
21	261	Lourtie, Martin (HELHA)	NA
22	260	Lecocq, Florian (HEPH Condorcet)	NA
23	253	Enfert, Paul (HELHA)	NA
24	271	Van Aerschot, Aurélien (HELHA)	NA
25	267	Ricard, Colomé Jimenez (KUL)	NA
26	274	Zentgraf, Andrew (KUL)	NA
27	258	Jacobs, Elias (KUL)	NA
28	245	Bouamrane, Marwane (HELHA)	NA
29	248	Coppieters, Thomas (UCL Wolves)	NA
30	255	Fougère, Fabien (HE Vinci)	NA

Résultats du Championnat FSUB de Cyclisme Dames

Sinaii

Dimanche 7 mai 2023



HoGent



EIND KLASSEMENT	NAAM	ONDERWIJNSINSTELLING	RUG NUMMER
1	Poppe Febe	UGent	21
2	Michotte Maëlle	HEPL	89
3	De Vos Nele	KU Leuven	87
4	Sadoine Perrine	HEPH- Condorcet	83
5	Huvenne Marie	KU Leuven	33
6	Van Baelen Nele	UCLL	81
7	De Mits Maaïke	UGent	74
8	Galle Vicky	UGent	69
9	De Prijck Shania	Artevelde	17
10	De Meester Margot	KU Leuven	59
11	Van Den Eede Chloë	Odisee	26
12	Baute Morgane	Howest	50
13	Roes Maxime	UGent	70
DNF	Ströker Anaëlle	KU Leuven	95
DNF	Verhaeghe Marthe	Artevelde	75
DNF	Marien An-Sofie	AP Hogeschool	82
DNF	Deneef Naika	Vives	51
DNF	Fierens Estée	HoGent	62
DNF	Dhont Kiona	Odisee	37
DNF	Heytens Renée	UGent	76
DNF	Uyttenhove Aiko	UGent	30
DNF	D'Hauwe Silke	UGent	12
DNF	De Zutter Hanne	Artevelde	15
DNF	De Schoenmaeker Sam	UAntwerpen	38
DNF	Van Elsacker Floor	Thomas More	39

Résultats du Championnat FSUB de Cyclisme Hommes

Zomergem

Mardi 27 juin 2023



HoGent



Plaats	RUG	Naam	Voornaam	Instelling	Tijd
1	16	BONTINCK	Jarne	UGent	02:15:24
2	49	DEKONING	Fabrizio	UGent	02:15:24
3	6	VAN SPEYBROEK	Matti	KU Leuven	02:15:24
4	107	VAN DEN BRANDEN	Rune	UGent	02:15:24
5	110	MAES	Alec	Odisee	02:15:24
6	10	VAN DE VELDE	Senne	UGent	02:15:24
7	8	HEYMAN	Jasper	Howest	02:15:24
8	108	GALLE	Senne	HOGENT	02:15:24
9	55	BOLLENGIER	Andreas	UGent	02:15:24
10	74	LONGUEVILLE	Kiran	Howest	02:15:24
11	106	REYNS	Elias	HOGENT	02:15:24
12	11	DEWINTER	Gerben	UGent	02:15:24
13	85	MAHY	Théo	UCL	02:15:24
14	83	WILLEMSSENS	Robbe	Thomas More	02:15:24
15	125	BEECKMAN	Gauthier	HOGENT	02:15:24
16	99	VAN DUYSEN	Robbe	HOGENT	02:15:24
17	65	CALLEBAUT	Lenny	HOGENT	02:15:24
18	70	DEVISCH	Lennert	Howest	02:15:24
19	73	STRAGIER	Emiel	HOGENT	02:15:24
20	119	DE GROOTE	Dries	AP	02:15:24
21	57	NOTEBAERT	Kamiel	HOGENT	02:15:24
22	135	VAN KERCKVOORDE	Gilles	UGent	02:15:24
23	59	BRESSELEERS	Jonas	AP	02:15:24
24	114	MARTENS	Michiel	UGent	02:15:24
25	138	MOERMAN	Stijn	VIVES	02:15:24
26	18	GYSELINCK	Lennert	UGent	02:15:24
	38	BASSEZ	Yoran	HOGENT	DNF
	136	PLOVIE	Tom	UGent	DNF
	155	VERNAILLEN	Jonas	KU Leuven	DNF

Résultats du championnat FSUB d'Échecs
Odisee Hogeschool (Campus Brussel)
Mercredi 15 février 2023





Championnat déchechs des étudiants de Belgique à Odisee KU Leuven campus de Bruxelles



Organisateur: **Baptist Bosmans**
 Arbitre(s): **Scaillet Timothé**
 Tournoi: **Suisse Rapide (7 Rondes)**
 Cadence: **15 min. QPF**
 Dates: **du 15/02/2023 au 15/02/2023**
 Départages: **B Cut1, Buch, S.B, Cum., R.Mut**



R1 R2 R3 R4 R5 R6 R7 Fiches Grille Amér caine

Classement final

	Cl.	Pr.	Nom Prénom	U Elo	Part.	Pts	XtPts	P.Tot.	Perf	B Cut1	Buch	S.B	Cum.	R.Mut
Arteveldehogeschool	1		Boudry, William	2128	7	6.0	0.0	6.0	2128	27.00	30.00	25.00	23.0	-
UAntwerpen	2		Tikranian, Alik	2303	7	6.0	0.0	6.0	2258	26.50	28.50	23.25	24.5	-
Arteveldehogeschool	3		De Block, Yordi	2119	7	6.0	0.0	6.0	2091	24.00	26.50	22.25	23.5	-
UCLouvain Wolves	4		Dallemagne, Maximilien	2106	7	5.5	0.0	5.5	2150	29.50	32.50	23.50	26.0	-
UAntwerpen	5		Van Dijck, Bjarne	2119	7	5.5	0.0	5.5	1989	26.00	28.00	21.25	20.5	-
KU Leuven	6		Melkonyan, Gor	1971	7	5.0	0.0	5.0	1993	29.50	32.50	21.00	24.0	-
Hogeschool VIVES	7		Da Silva Heleno, Jorit	1904	7	5.0	0.0	5.0	1939	28.50	30.00	19.00	21.5	-
KU Leuven	8		Najar, Nima	1763	7	5.0	0.0	5.0	1833	27.50	30.50	20.00	22.0	-
AP Hogeschool Antwerpen	9		Lascar, Radoslawa	1771	7	5.0	0.0	5.0	1690	25.00	27.00	16.50	21.0	-
KU Leuven	10		Smets, Remy	1478	7	5.0	0.0	5.0	1303	22.00	24.50	16.50	19.0	-
Thomas More	11		Motmans, Matthias	1615	7	5.0	0.0	5.0	1381	21.50	23.50	15.00	17.0	-
UCLouvain Wolves	12		Vernimmen, Pierre	1952	7	4.5	0.0	4.5	1933	30.50	34.50	19.75	22.5	-
UC Leuven	13		Rotaru, Teodor	1922	7	4.5	0.0	4.5	1801	27.50	30.00	16.25	21.5	-
UGent	14		Vanbeselaere, Victor	0	7	4.5	0.0	4.5	1497	27.50	29.50	17.75	20.0	-
KU Leuven	15		De Schoutheete, Manuel	1452	7	4.5	0.0	4.5	1505	27.50	29.50	15.75	18.5	-
ULB Owls	16		Deneuille, Walter	0	7	4.5	0.0	4.5	1599	26.50	29.50	18.75	18.0	-
KU Leuven	17		De Praitere, Hannes	1408	7	4.5	0.0	4.5	1329	21.50	22.00	10.75	16.0	-
UC Limburg	18		Nishat, Huseynli	0	7	4.5	0.0	4.5	528	20.00	22.00	13.00	13.0	-
UGent	19		Debaere, Thomas	0	7	4.0	0.0	4.0	1359	28.00	31.00	14.50	15.0	-
UGent	20		Dieleman, Lucas	0	7	4.0	0.0	4.0	1261	26.00	29.00	15.00	15.0	-
UGent	21		Rycx, Maarten	0	7	4.0	0.0	4.0	1254	25.00	28.00	13.50	19.0	-
KU Leuven	22		Meersman, Nicolas	0	7	4.0	0.0	4.0	1270	24.00	26.00	13.50	17.0	-
UAntwerpen	23		Van Dromme, Alex	0	6	4.0	0.0	4.0	294	22.50	24.00	12.00	16.0	-
UCLouvain Wolves	24		Cailteux, Thomas	0	7	4.0	0.0	4.0	785	22.00	24.00	12.00	17.0	-
Hogeschool Gent	25		Demey, Lotte	1616	7	4.0	0.0	4.0	1380	22.00	24.00	10.50	16.0	-
UCLouvain Wolves	26		Standaert, Matias	0	7	4.0	0.0	4.0	425	22.00	23.50	11.50	14.0	-
UCLouvain Wolves	27		Charon, Louis	0	7	4.0	0.0	4.0	322	21.50	23.00	10.50	15.0	-
KU Leuven	28		Dewijngaert, Lukas	0	7	4.0	0.0	4.0	351	20.50	22.50	11.00	11.0	-
KU Leuven	29		De Briey, Aurian	1697	7	3.5	0.0	3.5	1593	28.00	29.50	11.00	18.5	-
UAntwerpen	30		Pouliart, Sander	1494	7	3.5	0.0	3.5	1263	26.00	28.50	12.50	17.0	-
UGent	31		De Keyser, Renaat	0	6	3.5	0.0	3.5	622	24.50	26.50	9.75	11.0	-
KU Leuven	32		van Betsbrugge, Ewout	0	7	3.5	0.0	3.5	678	24.00	26.00	10.00	14.0	-
UAntwerpen	33		Witters, Michael	1435	7	3.5	0.0	3.5	1149	23.50	25.00	8.25	16.0	-
KU Leuven	34		Biltjes, Miguel	0	7	3.0	0.0	3.0	554	27.00	29.50	10.00	16.0	-
VUB	35	A	Bouakhounov, Amal	0	4	3.0	0.0	3.0	964	24.00	27.00	9.00	16.0	-
KU Leuven	36		Coenen, Jonah	1687	7	3.0	0.0	3.0	1254	23.00	25.00	8.50	13.0	-
Odisee Hogeschool	37		Craninx-Lamotte, Oisín	0	7	3.0	0.0	3.0	254	22.50	24.00	6.50	13.0	-
KU Leuven	38		Ali, Zia	0	7	3.0	0.0	3.0	253	22.00	24.00	6.50	14.0	-
KU Leuven	39		Willems, Cisse	0	7	3.0	0.0	3.0	595	21.00	22.50	7.00	14.0	-
KU Leuven	40		Ooghe, Rune	0	7	3.0	0.0	3.0	325	19.50	21.00	5.00	9.0	-
KU Leuven	41		Orshybek, Alzhan	0	4	3.0	0.0	3.0	202	19.00	20.50	6.00	9.0	-
UCLouvain Wolves	42		Servais, Arnaud	0	7	3.0	0.0	3.0	202	18.00	20.00	6.50	11.0	-
KU Leuven	43		Sanzhar, Bolatov	0	6	3.0	0.0	3.0	75	17.50	19.50	6.50	10.0	-
KU Leuven	44	A	Skup, Antoni	0	5	2.5	0.0	2.5	626	22.50	24.00	6.25	13.5	-
Odisee Hogeschool	45		Acke, Pierre	0	7	2.5	0.0	2.5	109	22.00	24.00	6.75	9.5	-
KU Leuven	46		Shamardan, Zhanibek	0	6	2.5	0.0	2.5	-193	20.50	22.00	6.75	8.5	-
KU Leuven	47		Ost, Emanuel	0	7	2.5	0.0	2.5	371	19.50	20.00	3.50	9.5	-
UAntwerpen	48		Kempka, Oskar	0	7	2.0	0.0	2.0	629	24.50	25.00	3.50	7.0	-
KU Leuven	49		Naudts, Ruben	0	7	2.0	0.0	2.0	442	21.00	23.00	4.50	11.0	-
UCLouvain Wolves	50		Deltenre, Guillaume	1150	7	2.0	0.0	2.0	706	21.00	21.50	3.00	11.0	-
KU Leuven	51		El Mohor, Bassel	0	6	2.0	0.0	2.0	993	20.50	21.00	2.00	10.0	-
	52		Daniel, Massoud	0	6	2.0	0.0	2.0	132	18.50	20.00	3.50	9.0	-
KU Leuven	53		Murrath, Timon	0	7	2.0	0.0	2.0	314	18.50	19.00	3.00	6.0	-
KU Leuven	54	A	Froyen, Arno	0	4	1.0	0.0	1.0	-201	20.00	21.00	1.00	3.0	-

KU Leuven	55	A	Kochetkov, Ivan	0	3	1.0	0.0	1.0	478	18.50	20.50	2.00	5.0	-
KU Leuven	56	A	Madwanna, Rishabh	0	5	1.0	0.0	1.0	342	18.50	20.00	1.50	6.0	-
ULB Owls	57	A	Deneuille, Elisabeth	0	4	1.0	0.0	1.0	346	18.00	19.50	1.50	4.0	-
Odisee Hogeschool	58	A	Vo, Cindy	0	4	1.0	0.0	1.0	-677	17.50	19.50	2.50	6.0	-
Thomas More	59	A	Kumar, Aryan	0	4	1.0	0.0	1.0	106	16.50	17.50	1.00	3.0	-
Odisee	60		Santiago Solaro, Morrison	0	6	1.0	0.0	1.0	-374	15.50	17.50	2.00	5.0	-
KU Leuven	61	A	Chalienko, Polina	0	3	0.0	0.0	0.0	-677	17.50	18.50	0.00	0.0	-
KU Leuven	62	A	Diana, Ashim	0	1	0.0	0.0	0.0	1501	17.50	18.50	0.00	0.0	-
KU Leuven	63	A	Roshaanay, Ali	0	1	0.0	0.0	0.0	982	17.00	18.00	0.00	0.0	-
KU Leuven	64	A	Baeke, Elgeo	0	4	0.0	0.0	0.0	-677	16.50	17.50	0.00	0.0	-
UGent	65	A	Thong, Wei Jeun	0	0	0.0	0.0	0.0	0	16.50	17.50	0.00	0.0	-
Haut de p ge														

Ronde 1 (15/02/2023) Résultats

Tbl	Nom Prénom	Points	N Elo	Res.	Nom Prénom	Points	N Elo
1	Tikranian, Alik	0.0	(2303)	1-0	De Keyser, Renaat	0.0	(0)
2	Debaere, Thomas	0.0	(0)	0-1	Boudry, William	0.0	(2128)
3	De Block, Yordi	0.0	(2119)	1-0	Deneuille, Elisabeth	0.0	(0)
4	Deneuille, Walter	0.0	(0)	1-0	Van Dijck, Bjarne	0.0	(2119)
5	Dallemagne, Maximilien	0.0	(2106)	1-0	Dewijngaert, Lukas	0.0	(0)
6	Diana, Ashim	0.0	(0)	0-1	Melkonyan, Gor	0.0	(1971)
7	Vernimmen, Pierre	0.0	(1952)	1-0	Dieleman, Lucas	0.0	(0)
8	El Mohor, Bassel	0.0	(0)	0-1	Rotaru, Teodor	0.0	(1922)
9	Da Silva Heleno, Jorit	0.0	(1904)	1-0	Froyen, Arno	0.0	(0)
10	Kempka, Oskar	0.0	(0)	0-1	Laszar, Radoslawa	0.0	(1771)
11	Najar, Nima	0.0	(1763)	1-0	Kochetkov, Ivan	0.0	(0)
12	Kumar, Aryan	0.0	(0)	0-1	De Briey, Aurian	0.0	(1697)
13	Ost, Emanuel	0.0	(0)	1-0	Madwanna, Rishabh	0.0	(0)
14	Meersman, Nicolas	0.0	(0)	0-1	Coenen, Jonah	0.0	(1687)
15	Demey, Lotte	0.0	(1616)	1-0	Murrath, Timon	0.0	(0)
16	Naudts, Ruben	0.0	(0)	0-1	Motmans, Matthias	0.0	(1615)
17	Pouliart, Sander	0.0	(1494)	1-0	Nishat, Huseynli	0.0	(0)
18	Ooghe, Rune	0.0	(0)	0-1	Smets, Remy	0.0	(1478)
19	De Schoutheete, Manuel	0.0	(1452)	1-0	Roshaanay, Ali	0.0	(0)
20	Rycx, Maarten	0.0	(0)	1-0	Witters, Michael	0.0	(1435)
21	De Praitere, Hannes	0.0	(1408)	1-0	Santiago Solaro, Morrison	0.0	(0)
22	Sanzhar, Bolatov	0.0	(0)	0-1	Deltenre, Guillaume	0.0	(1150)
23	Acke, Pierre	0.0	(0)	0-1	Servais, Arnaud	0.0	(0)
24	Shamardan, Zhanibek	0.0	(0)	0-1	Ali, Zia	0.0	(0)
25	Baeke, Elgeo	0.0	(0)	0-1	Skup, Antoni	0.0	(0)
26	Standaert, Matias	0.0	(0)	0-1	Biltjes, Miguel	0.0	(0)
27	Bouakhounov, Amal	0.0	(0)	1ff-0	Thong, Wei Jeun	0.0	(0)
28	Van Dromme, Alex	0.0	(0)	0-1	Cailteux, Thomas	0.0	(0)
29	Chalienko, Polina	0.0	(0)	0-1	Vanbeselaere, Victor	0.0	(0)
30	Vo, Cindy	0.0	(0)	0-1	Charon, Louis	0.0	(0)
31	Craninx-Lamotte, Oisin	0.0	(0)	0-1	Willems, Cisse	0.0	(0)
32	van Betsbrugge, Ewout	0.0	(0)	1-0	Daniel, Massoud	0.0	(0)
	Orshybek, Alzhan	0.0	(0)	0	Absent		
Haut de page							

Ronde 2 (15/02/2023) Résultats

Tbl	Nom Prénom	Points	N Elo	Res.	Nom Prénom	Points	N Elo
1	Deltenre, Guillaume	1.0	(1150)	0-1	Tikranian, Alik	1.0	(2303)
2	Boudry, William	1.0	(2128)	1-0	De Schoutheete, Manuel	1.0	(1452)
3	Ali, Zia	1.0	(0)	0-1	De Block, Yordi	1.0	(2119)
4	Biltjes, Miguel	1.0	(0)	0-1	Dallemagne, Maximilien	1.0	(2106)
5	Melkonyan, Gor	1.0	(1971)	1-0	De Praitere, Hannes	1.0	(1408)
6	Cailteux, Thomas	1.0	(0)	0-1	Vernimmen, Pierre	1.0	(1952)
7	Rotaru, Teodor	1.0	(1922)	1-0	Bouakhounov, Amal	1.0	(0)
8	Charon, Louis	1.0	(0)	0-1	Da Silva Heleno, Jorit	1.0	(1904)
9	Lascar, Radoslawa	1.0	(1771)	0-1	Deneuille, Walter	1.0	(0)
10	Servais, Arnaud	1.0	(0)	0-1	Najar, Nima	1.0	(1763)
11	De Briey, Aurian	1.0	(1697)	1-0	Ost, Emanuel	1.0	(0)
12	Coenen, Jonah	1.0	(1687)	0-1	Rycx, Maarten	1.0	(0)
13	Skup, Antoni	1.0	(0)	0-1	Demey, Lotte	1.0	(1616)
14	Motmans, Matthias	1.0	(1615)	0-1	Vanbeselaere, Victor	1.0	(0)
15	Willems, Cisse	1.0	(0)	0-1	Pouliart, Sander	1.0	(1494)
16	Smets, Remy	1.0	(1478)	½-½	van Betsbrugge, Ewout	1.0	(0)
17	Van Dijck, Bjarne	0.0	(2119)	1-0	Kempka, Oskar	0.0	(0)
18	Witters, Michael	0.0	(1435)	1-0	Kumar, Aryan	0.0	(0)
19	Kochetkov, Ivan	0.0	(0)	0-1	Acke, Pierre	0.0	(0)
20	Madwanna, Rishabh	0.0	(0)	1-0	Baeke, Elgeo	0.0	(0)
21	Meersman, Nicolas	0.0	(0)	1-0	Chalienko, Polina	0.0	(0)
22	Murrath, Timon	0.0	(0)	0-1	Craninx-Lamotte, Oisín	0.0	(0)
23	Daniel, Massoud	0.0	(0)	0-1	Naudts, Ruben	0.0	(0)
24	De Keyser, Renaat	0.0	(0)	1-0	Ooghe, Rune	0.0	(0)
25	Nishat, Huseynli	0.0	(0)	0-1	Debaere, Thomas	0.0	(0)
26	Deneuille, Elisabeth	0.0	(0)	0-1	Sanzhar, Bolatov	0.0	(0)
27	Dewijngaert, Lukas	0.0	(0)	0-1	Shamardan, Zhanibek	0.0	(0)
28	Roshaanay, Ali	0.0	(0)	Off-Off	Diana, Ashim	0.0	(0)
29	Dieleman, Lucas	0.0	(0)	1-0	Standaert, Matias	0.0	(0)
30	Santiago Solaro, Morrison	0.0	(0)	0-1	El Mohor, Bassel	0.0	(0)
31	Froyen, Arno	0.0	(0)	0-1	Van Dromme, Alex	0.0	(0)
	Vo, Cindy	0.0	(0)	1	Bye		
	Orshybek, Alzhan	0.0	(0)	0	Absent		
	Thong, Wei Jeun	0.0	(0)	0	Absent		

Haut de page

Ronde 3 (15/02/2023) Résultats							
Tbl	Nom Prénom	Points	N Elo	Res.	Nom Prénom	Points	N Elo
1	Tikranian, Alik	2.0	(2303)	½-½	Da Silva Heleno, Jorit	2.0	(1904)
2	Najar, Nima	2.0	(1763)	1-0	Boudry, William	2.0	(2128)
3	De Block, Yordi	2.0	(2119)	½-½	De Briey, Aurian	2.0	(1697)
4	Dallemagne, Maximilien	2.0	(2106)	1-0	Demey, Lotte	2.0	(1616)
5	Pouliart, Sander	2.0	(1494)	0-1	Melkonyan, Gor	2.0	(1971)
6	Vernimmen, Pierre	2.0	(1952)	1-0	Deneuille, Walter	2.0	(0)
7	Rycx, Maarten	2.0	(0)	0-1	Rotaru, Teodor	2.0	(1922)
8	Vanbeselaere, Victor	2.0	(0)	1-0	Smets, Remy	1.5	(1478)
9	van Betsbrugge, Ewout	1.5	(0)	0-1	Van Dijck, Bjarne	1.0	(2119)
10	De Keyser, Renaat	1.0	(0)	0-1	Lascar, Radoslaw	1.0	(1771)
11	Debaere, Thomas	1.0	(0)	1-0	Coenen, Jonah	1.0	(1687)
12	Dieleman, Lucas	1.0	(0)	1-0	Motmans, Matthias	1.0	(1615)
13	De Schoutheete, Manuel	1.0	(1452)	1-0	Madwanna, Rishabh	1.0	(0)
14	El Mohor, Bassel	1.0	(0)	0-1	Witters, Michael	1.0	(1435)
15	De Praitere, Hannes	1.0	(1408)	0-1	Meersman, Nicolas	1.0	(0)
16	Naudts, Ruben	1.0	(0)	1-0	Deltenre, Guillaume	1.0	(1150)
17	Acke, Pierre	1.0	(0)	½-½	Skup, Antoni	1.0	(0)
18	Ost, Emanuel	1.0	(0)	0-1	Ali, Zia	1.0	(0)
19	Sanzhar, Bolatov	1.0	(0)	0-1	Biltjes, Miguel	1.0	(0)
20	Bouakhounov, Amal	1.0	(0)	1-0	Servais, Arnaud	1.0	(0)
21	Shamardan, Zhanibek	1.0	(0)	0-1	Cailteux, Thomas	1.0	(0)
22	Van Dromme, Alex	1.0	(0)	1-0	Charon, Louis	1.0	(0)
23	Craninx-Lamotte, Oisín	1.0	(0)	1-0	Vo, Cindy	1.0	(0)
24	Baeke, Elgeo	0.0	(0)	0-1	Willems, Cisse	1.0	(0)
25	Chalienko, Polina	0.0	(0)	0-1	Kochetkov, Ivan	0.0	(0)
26	Kumar, Aryan	0.0	(0)	0-1	Daniel, Massoud	0.0	(0)
27	Murrath, Timon	0.0	(0)	1-0	Deneuille, Elisabeth	0.0	(0)
28	Ooghe, Rune	0.0	(0)	0-1	Dewijngaert, Lukas	0.0	(0)
29	Roshaanay, Ali	0.0	(0)	Off-Off	Diana, Ashim	0.0	(0)
30	Standaert, Matias	0.0	(0)	1-0	Froyen, Arno	0.0	(0)
31	Kempka, Oskar	0.0	(0)	0-1	Nishat, Huseynli	0.0	(0)
	Santiago Solaro, Morrison	0.0	(0)	1	Bye		
	Orshybek, Alzhan	0.0	(0)	0	Absent		
	Thong, Wei Jeun	0.0	(0)	0	Absent		

Haut de page

Ronde 4 (15/02/2023) Résultats

Tbl	Nom Prénom	Points	N Elo	Res.	Nom Prénom	Points	N Elo
1	Rotaru, Teodor	3.0	(1922)	0-1	Dallemagne, Maximilien	3.0	(2106)
2	Melkonyan, Gor	3.0	(1971)	1-0	Najar, Nima	3.0	(1763)
3	Vanbeselaere, Victor	3.0	(0)	0-1	Vernimmen, Pierre	3.0	(1952)
4	De Briey, Aurian	2.5	(1697)	0-1	Tikranian, Alik	2.5	(2303)
5	Da Silva Heleno, Jorit	2.5	(1904)	½-½	De Block, Yordi	2.5	(2119)
6	Boudry, William	2.0	(2128)	1-0	Craninx-Lamotte, Oisin	2.0	(0)
7	Van Dijck, Bjarne	2.0	(2119)	1-0	Debaere, Thomas	2.0	(0)
8	Lascar, Radoslaw	2.0	(1771)	1-0	Dieleman, Lucas	2.0	(0)
9	Demey, Lotte	2.0	(1616)	0-1	Meersman, Nicolas	2.0	(0)
10	Cailteux, Thomas	2.0	(0)	1-0	Pouliart, Sander	2.0	(1494)
11	Deneuville, Walter	2.0	(0)	0-1	De Schoutheete, Manuel	2.0	(1452)
12	Witters, Michael	2.0	(1435)	1-0	Naudts, Ruben	2.0	(0)
13	Ali, Zia	2.0	(0)	0-1	Rycx, Maarten	2.0	(0)
14	Biltjes, Miguel	2.0	(0)	1-0	Van Dromme, Alex	2.0	(0)
15	Willems, Cisse	2.0	(0)	0-1	Bouakhounov, Amal	2.0	(0)
16	Smets, Remy	1.5	(1478)	1-0	Acke, Pierre	1.5	(0)
17	Skup, Antoni	1.5	(0)	1-0	van Betsbrugge, Ewout	1.5	(0)
18	Coenen, Jonah	1.0	(1687)	1-0	Murrath, Timon	1.0	(0)
19	Motmans, Matthias	1.0	(1615)	1-0	Ost, Emanuel	1.0	(0)
20	Madwanna, Rishabh	1.0	(0)	0-1	De Praitere, Hannes	1.0	(1408)
21	Deltenre, Guillaume	1.0	(1150)	1-0	Santiago Solaro, Morrison	1.0	(0)
22	Charon, Louis	1.0	(0)	1-0	Sanzhar, Bolatov	1.0	(0)
23	Daniel, Massoud	1.0	(0)	1-0	Shamardan, Zhanibek	1.0	(0)
24	Nishat, Huseynli	1.0	(0)	½-½	De Keyser, Renaat	1.0	(0)
25	Dewijngaert, Lukas	1.0	(0)	0-1	Standaert, Matias	1.0	(0)
26	Vo, Cindy	1.0	(0)	0-1	El Mohor, Bassel	1.0	(0)
27	Servais, Arnaud	1.0	(0)	0-1	Kempka, Oskar	0.0	(0)
28	Orshybek, Alzhan	0.0	(0)	1-0	Baeke, Elgeo	0.0	(0)
29	Deneuville, Elisabeth	0.0	(0)	1-0	Kumar, Aryan	0.0	(0)
30	Froyen, Arno	0.0	(0)	0-1	Ooghe, Rune	0.0	(0)
	Chalienko, Polina	0.0	(0)	0	Absent		
	Diana, Ashim	0.0	(0)	0	Absent		
	Kochetkov, Ivan	1.0	(0)	0	Absent		
	Roshaanay, Ali	0.0	(0)	0	Absent		
	Thong, Wei Jeun	0.0	(0)	0	Absent		

Haut de page

Ronde 5 (15/02/2023) Résultats

Tbl	Nom Prénom	Points	N Elo	Res.	Nom Prénom	Points	N Elo
1	Dallemagne, Maximilien	4.0	(2106)	1-0	Melkonyan, Gor	4.0	(1971)
2	Vernimmen, Pierre	4.0	(1952)	0-1	Tikranian, Alik	3.5	(2303)
3	Witters, Michael	3.0	(1435)	0-1	Boudry, William	3.0	(2128)
4	De Block, Yordi	3.0	(2119)	1-0	Biltjes, Miguel	3.0	(0)
5	De Schoutheete, Manuel	3.0	(1452)	0-1	Van Dijck, Bjarne	3.0	(2119)
6	Meersman, Nicolas	3.0	(0)	0-1	Rotaru, Teodor	3.0	(1922)
7	Bouakhounov, Amal	3.0	(0)	0-1	Da Silva Heleno, Jorit	3.0	(1904)
8	Rycx, Maarten	3.0	(0)	0-1	Lascar, Radoslawa	3.0	(1771)
9	Najar, Nima	3.0	(1763)	1-0	Vanbeselaere, Victor	3.0	(0)
10	De Briey, Aurian	2.5	(1697)	1-0	Cailteux, Thomas	3.0	(0)
11	Skup, Antoni	2.5	(0)	0-1	Smets, Remy	2.5	(1478)
12	Dieleman, Lucas	2.0	(0)	1-0	Coenen, Jonah	2.0	(1687)
13	Debaere, Thomas	2.0	(0)	1-0	Demey, Lotte	2.0	(1616)
14	El Mohor, Bassel	2.0	(0)	0-1	Motmans, Matthias	2.0	(1615)
15	Pouliart, Sander	2.0	(1494)	1-0	Daniel, Massoud	2.0	(0)
16	De Praitere, Hannes	2.0	(1408)	1-0	Willems, Cisse	2.0	(0)
17	Standaert, Matias	2.0	(0)	1-0	Deltenre, Guillaume	2.0	(1150)
18	Van Dromme, Alex	2.0	(0)	1-0	Ali, Zia	2.0	(0)
19	Naudts, Ruben	2.0	(0)	0-1	Charon, Louis	2.0	(0)
20	Craninx-Lamotte, Oisin	2.0	(0)	0-1	Deneuille, Walter	2.0	(0)
21	Acke, Pierre	1.5	(0)	0-1	Nishat, Huseynli	1.5	(0)
22	van Betsbrugge, Ewout	1.5	(0)	1-0	De Keyser, Renaat	1.5	(0)
23	Ost, Emanuel	1.0	(0)	0-1	Dewijngaert, Lukas	1.0	(0)
24	Santiago Solaro, Morrison	1.0	(0)	0-1	Kempka, Oskar	1.0	(0)
25	Sanzhar, Bolatov	1.0	(0)	1-0	Madwanna, Rishabh	1.0	(0)
26	Murrath, Timon	1.0	(0)	0-1	Servais, Arnaud	1.0	(0)
27	Ooghe, Rune	1.0	(0)	1-0	Vo, Cindy	1.0	(0)
28	Shamardan, Zhanibek	1.0	(0)	0-1	Orshybek, Alzhan	1.0	(0)
29	Baeke, Elgeo	0.0	(0)	0-1ff	Froyen, Arno	0.0	(0)
	Kumar, Aryan	0.0	(0)	1	Bye		
	Chalienko, Polina	0.0	(0)	0	Absent		
	Deneuille, Elisabeth	1.0	(0)	0	Absent		
	Diana, Ashim	0.0	(0)	0	Absent		
	Kochetkov, Ivan	1.0	(0)	0	Absent		
	Roshaanay, Ali	0.0	(0)	0	Absent		
	Thong, Wei Jeun	0.0	(0)	0	Absent		

Haut de page

Ronde 6 (15/02/2023) Résultats

Tbl	Nom Prénom	Points	N Elo	Res.	Nom Prénom	Points	N Elo
1	Tikranian, Alik	4.5	(2303)	½-½	Dallemagne, Maximilien	5.0	(2106)
2	Boudry, William	4.0	(2128)	1-0	Vernimmen, Pierre	4.0	(1952)
3	Rotaru, Teodor	4.0	(1922)	0-1	De Block, Yordi	4.0	(2119)
4	Van Dijck, Bjarne	4.0	(2119)	1-0	Najar, Nima	4.0	(1763)
5	Da Silva Heleno, Jorit	4.0	(1904)	0-1	Melkonyan, Gor	4.0	(1971)
6	Lascar, Radoslawa	4.0	(1771)	1-0	De Briey, Aurian	3.5	(1697)
7	Smets, Remy	3.5	(1478)	½-½	Pouliart, Sander	3.0	(1494)
8	Motmans, Matthias	3.0	(1615)	1-0	Debaere, Thomas	3.0	(0)
9	De Schoutheete, Manuel	3.0	(1452)	1-0	Dieleman, Lucas	3.0	(0)
10	Deneuville, Walter	3.0	(0)	½-½	Witters, Michael	3.0	(1435)
11	Vanbeselaere, Victor	3.0	(0)	½-½	De Praitere, Hannes	3.0	(1408)
12	Biltjes, Miguel	3.0	(0)	0-1	Meersman, Nicolas	3.0	(0)
13	Cailteux, Thomas	3.0	(0)	0-1	Rycx, Maarten	3.0	(0)
14	Charon, Louis	3.0	(0)	0-1	Standaert, Matias	3.0	(0)
15	Van Dromme, Alex	3.0	(0)	1ff-0	Skup, Antoni	2.5	(0)
16	Nishat, Huseynli	2.5	(0)	1-0	van Betsbrugge, Ewout	2.5	(0)
17	Coenen, Jonah	2.0	(1687)	1-0	El Mohor, Bassel	2.0	(0)
18	Kempka, Oskar	2.0	(0)	0-1	Demey, Lotte	2.0	(1616)
19	Deltenre, Guillaume	2.0	(1150)	0-1	Ooghe, Rune	2.0	(0)
20	Ali, Zia	2.0	(0)	1-0	Naudts, Ruben	2.0	(0)
21	Servais, Arnaud	2.0	(0)	0-1	Craninx-Lamotte, Oisin	2.0	(0)
22	Daniel, Massoud	2.0	(0)	0-1	Orshybek, Alzhan	2.0	(0)
23	Dewijngaert, Lukas	2.0	(0)	1-0	Sanzhar, Bolatov	2.0	(0)
24	Willems, Cisse	2.0	(0)	1-0	Acke, Pierre	1.5	(0)
25	De Keyser, Renaat	1.5	(0)	1-0	Murrath, Timon	1.0	(0)
26	Madwannan, Rishabh	1.0	(0)	0-1ff	Shamardan, Zhanibek	1.0	(0)
27	Santiago Solaro, Morrison	1.0	(0)	0-1	Ost, Emanuel	1.0	(0)
	Baeke, Elgeo	0.0	(0)	0	Absent		
	Bouakhounov, Amal	3.0	(0)	0	Absent		
	Chalienko, Polina	0.0	(0)	0	Absent		
	Deneuville, Elisabeth	1.0	(0)	0	Absent		
	Diana, Ashim	0.0	(0)	0	Absent		
	Froyen, Arno	1.0	(0)	0	Absent		
	Kochetkov, Ivan	1.0	(0)	0	Absent		
	Kumar, Aryan	1.0	(0)	0	Absent		
	Roshaanay, Ali	0.0	(0)	0	Absent		
	Thong, Wei Jeun	0.0	(0)	0	Absent		
	Vo, Cindy	1.0	(0)	0	Absent		

Haut de page

Ronde 7 (15/02/2023) Résultats							
Tbl	Nom Prénom	Points	N Elo	Res.	Nom Prénom	Points	N Elo
1	Dallemagne, Maximilien	5.5	(2106)	0-1	Boudry, William	5.0	(2128)
2	Melkonyan, Gor	5.0	(1971)	0-1	Tikranian, Alik	5.0	(2303)
3	De Block, Yordi	5.0	(2119)	1-0	Lascar, Radoslaw	5.0	(1771)
4	Vernimmen, Pierre	4.0	(1952)	½-½	Van Dijck, Bjarne	5.0	(2119)
5	Rotaru, Teodor	4.0	(1922)	½-½	De Schoutheete, Manuel	4.0	(1452)
6	Meersman, Nicolas	4.0	(0)	0-1	Da Silva Heleno, Jorit	4.0	(1904)
7	Najar, Nima	4.0	(1763)	1-0	Van Dromme, Alex	4.0	(0)
8	Rycx, Maarten	4.0	(0)	0-1	Motmans, Matthias	4.0	(1615)
9	Standaert, Matias	4.0	(0)	0-1	Smets, Remy	4.0	(1478)
10	De Briey, Aurian	3.5	(1697)	0-1	Deneuille, Walter	3.5	(0)
11	Pouliart, Sander	3.5	(1494)	0-1	Vanbeselaere, Victor	3.5	(0)
12	Witters, Michael	3.5	(1435)	0-1	Nishat, Huseynli	3.5	(0)
13	De Praitere, Hannes	3.5	(1408)	1-0	Coenen, Jonah	3.0	(1687)
14	Demey, Lotte	3.0	(1616)	1-0	Willems, Cisse	3.0	(0)
15	Debaere, Thomas	3.0	(0)	1-0	Ali, Zia	3.0	(0)
16	Dieleman, Lucas	3.0	(0)	1-0	Biltjes, Miguel	3.0	(0)
17	Ooghe, Rune	3.0	(0)	0-1	Cailteux, Thomas	3.0	(0)
18	Orshybek, Alzhan	3.0	(0)	0-1	Charon, Louis	3.0	(0)
19	Craninx-Lamotte, Oisin	3.0	(0)	0-1	Dewijngaert, Lukas	3.0	(0)
20	El Mohor, Bassel	2.0	(0)	0-1ff	De Keyser, Renaat	2.5	(0)
21	van Betsbrugge, Ewout	2.5	(0)	1-0	Deltenre, Guillaume	2.0	(1150)
22	Sanzhar, Bolatov	2.0	(0)	1ff-0	Daniel, Massoud	2.0	(0)
23	Naudts, Ruben	2.0	(0)	0-1	Servais, Arnaud	2.0	(0)
24	Ost, Emanuel	2.0	(0)	½-½	Shamardan, Zhanibek	2.0	(0)
25	Acke, Pierre	1.5	(0)	1-0	Kempka, Oskar	2.0	(0)
26	Murrath, Timon	1.0	(0)	1-0	Santiago Solaro, Morrison	1.0	(0)
	Baeke, Elgeo	0.0	(0)	0	Absent		
	Bouakhounov, Amal	3.0	(0)	0	Absent		
	Chalienko, Polina	0.0	(0)	0	Absent		
	Deneuille, Elisabeth	1.0	(0)	0	Absent		
	Diana, Ashim	0.0	(0)	0	Absent		
	Froyen, Arno	1.0	(0)	0	Absent		
	Kochetkov, Ivan	1.0	(0)	0	Absent		
	Kumar, Aryan	1.0	(0)	0	Absent		
	Madwanna, Rishabh	1.0	(0)	0	Absent		
	Roshaanay, Ali	0.0	(0)	0	Absent		
	Skup, Antoni	2.5	(0)	0	Absent		
	Thong, Wei Jeun	0.0	(0)	0	Absent		
	Vo, Cindy	1.0	(0)	0	Absent		

Haut de page

Grille Américaine

Cl.	Tit.	Nom	Rnk	N Elo	Perf.	Pts	R1	R2	R3	R4	R5	R6	R7	B Cut1	Buch	S.B	Cum.	R.Mut
1		Boudry, William	2	2128	2128	6.0	19 N 1	15 B 1	8 N 0	37 B 1	33 N 1	12 B 1	4 N 1	27.00	30.00	25.00	23.0	-
2	FM	Tikranian, Alik	1	2303	2258	6.0	31 B 1	50 N 1	7 B ½	29 N 1	12 N 1	4 B ½	6 N 1	26.50	28.50	23.25	24.5	-
3		De Block, Yordi	3	2119	2091	6.0	57 B 1	38 N 1	29 B ½	7 N ½	34 B 1	13 N 1	9 B 1	24.00	26.50	22.25	23.5	-
4		Dallemagne, Maximilien	5	2106	2150	5.5	28 B 1	34 N 1	25 B 1	13 N 1	6 B 1	2 N ½	1 B 0	29.50	32.50	23.50	26.0	-
5		Van Dijck, Bjarne	4	2119	1989	5.5	16 N 0	48 B 1	32 N 1	19 B 1	15 N 1	8 B 1	12 N ½	26.00	28.00	21.25	20.5	-
6		Melkonyan, Gor	6	1971	1993	5.0	62 N 1	17 B 1	30 N 1	8 B 1	4 N 0	7 N 1	2 B 0	29.50	32.50	21.00	24.0	-
7		Da Silva Heleno, Jorit	9	1904	1939	5.0	54 B 1	27 N 1	2 N ½	3 B ½	35 N 1	6 B 0	22 N 1	28.50	30.00	19.00	21.5	-
8		Najar, Nima	11	1763	1833	5.0	55 B 1	42 N 1	1 B 1	6 N 0	14 B 1	5 N 0	23 B 1	27.50	30.50	20.00	22.0	-
9		Lascar, Radoslaw	10	1771	1690	5.0	48 N 1	16 B 0	31 N 1	20 B 1	21 N 1	29 B 1	3 N 0	25.00	27.00	16.50	21.0	-
10		Smets, Remy	17	1478	1303	5.0	40 N 1	32 B ½	14 N 0	45 B 1	44 N 1	30 B ½	26 N 1	22.00	24.50	16.50	19.0	-
11		Motmans, Matthias	15	1615	1381	5.0	49 N 1	14 B 0	20 N 0	47 B 1	51 N 1	19 B 1	21 N 1	21.50	23.50	15.00	17.0	-
12		Vernimmen, Pierre	7	1952	1933	4.5	20 B 1	24 N 1	16 B 1	14 N 1	2 B 0	1 N 0	5 B ½	30.50	34.50	19.75	22.5	-
13		Rotaru, Teodor	8	1922	1801	4.5	51 N 1	35 B 1	21 N 1	4 B 0	22 N 1	3 B 0	15 B ½	27.50	30.00	16.25	21.5	-
14		Vanbeselaere, Victor	62	0	1497	4.5	61 N 1	11 N 1	10 B 1	12 B 0	8 N 0	17 B ½	30 N 1	27.50	29.50	17.75	20.0	-
15		De Schoutheete, Manuel	18	1452	1505	4.5	63 B 1	1 N 0	56 B 1	16 N 1	5 B 0	20 B 1	13 N ½	27.50	29.50	15.75	18.5	-
16		Deneuille, Walter	35	0	1599	4.5	5 B 1	9 N 1	12 N 0	15 B 0	37 N 1	33 B ½	29 N 1	26.50	29.50	18.75	18.0	-
17		De Praitere, Hannes	20	1408	1329	4.5	60 B 1	6 N 0	22 B 0	56 N 1	39 B 1	14 N ½	36 B 1	21.50	22.00	10.75	16.0	-
18		Nishat, Huseynli	48	0	528	4.5	30 N 0	19 B 0	48 N 1	31 B ½	45 N 1	32 B 1	33 N 1	20.00	22.00	13.00	13.0	-
19		Debaere, Thomas	33	0	1359	4.0	1 B 0	18 N 1	36 B 1	5 N 0	25 B 1	11 N 0	38 B 1	28.00	31.00	14.50	15.0	-
20		Dieleman, Lucas	38	0	1261	4.0	12 N 0	26 B 1	11 B 1	9 N 0	36 B 1	15 N 0	34 B 1	26.00	29.00	15.00	15.0	-
21		Rycx, Maarten	53	0	1254	4.0	33 B 1	36 N 1	13 B 0	38 N 1	9 B 0	24 N 1	11 B 0	25.00	28.00	13.50	19.0	-
22		Meersman, Nicolas	45	0	1270	4.0	36 B 0	61 B 1	17 N 1	25 N 1	13 B 0	34 N 1	7 B 0	24.00	26.00	13.50	17.0	-
23		Van Dromme, Alex	61	0	294	4.0	24 B 0	54 N 1	27 B 1	34 N 0	38 B 1	44 B 1FF	8 N 0	22.50	24.00	12.00	16.0	-
24		Cailteux, Thomas	27	0	785	4.0	23 N 1	12 B 0	46 N 1	30 B 1	29 N 0	21 B 0	40 N 1	22.00	24.00	12.00	17.0	-
25		Demey, Lotte	14	1616	1380	4.0	53 B 1	44 N 1	4 N 0	22 B 0	19 N 0	48 N 1	39 B 1	22.00	24.00	10.50	16.0	-
26		Standaert, Matias	59	0	425	4.0	34 B 0	20 N 0	54 B 1	28 N 1	50 B 1	27 N 1	10 B 0	22.00	23.50	11.50	14.0	-
27		Charon, Louis	29	0	322	4.0	58 N 1	7 B 0	23 N 0	43 B 1	49 N 1	26 B 0	41 N 1	21.50	23.00	10.50	15.0	-
28		Dewijngaert, Lukas	36	0	351	4.0	4 N 0	46 B 0	40 N 1	26 B 0	47 N 1	43 B 1	37 N 1	20.50	22.50	11.00	11.0	-
29		De Briey, Aurian	12	1697	1593	3.5	59 N 1	47 B 1	3 N ½	2 B 0	24 B 1	9 N 0	16 B 0	28.00	29.50	11.00	18.5	-
30		Pouliart, Sander	16	1494	1263	3.5	18 B 1	39 N 1	6 B 0	24 N 0	52 B 1	10 N ½	14 B 0	26.00	28.50	12.50	17.0	-
31		De Keyser, Renaat	32	0	622	3.5	2 N 0	40 B 1	9 B 0	18 N ½	32 N 0	53 B 1	51 N 1FF	24.50	26.50	9.75	11.0	-
32		van Betsbrugge, Ewout	65	0	678	3.5	52 B 1	10 N ½	5 B 0	44 N 0	31 B 1	18 N 0	50 B 1	24.00	26.00	10.00	14.0	-
33		Witters, Michael	19	1435	1149	3.5	21 N 0	59 B 1	51 N 1	49 B 1	1 B 0	16 N ½	18 B 0	23.50	25.00	8.25	16.0	-
34		Biltjes, Miguel	25	0	554	3.0	26 N 1	4 B 0	43 N 1	23 B 1	3 N 0	22 B 0	20 N 0	27.00	29.50	10.00	16.0	-
35		Bouakhounov, Amal	26	0	964	3.0	65 B 1FF	13 N 0	42 B 1	39 N 1	7 B 0	A	A	24.00	27.00	9.00	16.0	-
36		Coenen, Jonah	13	1687	1254	3.0	22 N 1	21 B 0	19 N 0	53 B 1	20 N 0	51 B 1	17 N 0	23.00	25.00	8.50	13.0	-
37		Craninx-Lamotte, Oisin	30	0	254	3.0	39 B 0	53 N 1	58 B 1	1 N 0	16 B 0	42 N 1	28 B 0	22.50	24.00	6.50	13.0	-

38	Ali, Zia	23 0	253	3.0	46 N 1	3 B 0	47 N 1	21 B 0	23 N 0	49 B 1	19 N 0	22.00	24.00	6.50	14.0	-
39	Willems, Cisse	64 0	595	3.0	37 N 1	30 B 0	64 N 1	35 B 0	17 N 0	45 B 1	25 N 0	21.00	22.50	7.00	14.0	-
40	Ooghe, Rune	49 0	325	3.0	10 B 0	31 N 0	28 B 0	54 N 1	58 B 1	50 N 1	24 B 0	19.50	21.00	5.00	9.0	-
41	Orshybek, Alzhan	50 0	202	3.0	A	A	A	64 B 1	46 N 1	52 N 1	27 B 0	19.00	20.50	6.00	9.0	-
42	Servais, Arnaud	56 0	202	3.0	45 N 1	8 B 0	35 N 0	48 B 0	53 N 1	37 B 0	49 N 1	18.00	20.00	6.50	11.0	-
43	Sanzhar, Bolatov	55 0	75	3.0	50 B 0	57 N 1	34 B 0	27 N 0	56 B 1	28 N 0	52 B 1FF	17.50	19.50	6.50	10.0	-
44	Skup, Antoni	58 0	626	2.5	64 N 1	25 B 0	45 N ½	32 B 1	10 B 0	23 N Off	A	22.50	24.00	6.25	13.5	-
45	Acke, Pierre	22 0	109	2.5	42 B 0	55 N 1	44 B ½	10 N 0	18 B 0	39 N 0	48 B 1	22.00	24.00	6.75	9.5	-
46	Shamardan, Zhanibek	57 0	-193	2.5	38 B 0	28 N 1	24 B 0	52 N 0	41 B 0	56 N 1FF	47 N ½	20.50	22.00	6.75	8.5	-
47	Ost, Emanuel	51 0	371	2.5	56 B 1	29 N 0	38 B 0	11 N 0	28 B 0	60 N 1	46 B ½	19.50	20.00	3.50	9.5	-
48	Kempka, Oskar	41 0	629	2.0	9 B 0	5 N 0	18 B 0	42 N 1	60 N 1	25 B 0	45 N 0	24.50	25.00	3.50	7.0	-
49	Naudts, Ruben	47 0	442	2.0	11 B 0	52 N 1	50 B 1	33 N 0	27 B 0	38 N 0	42 B 0	21.00	23.00	4.50	11.0	-
50	Deltenre, Guillaume	21 1150	706	2.0	43 N 1	2 B 0	49 N 0	60 B 1	26 N 0	40 B 0	32 N 0	21.00	21.50	3.00	11.0	-
51	El Mohor, Bassel	39 0	993	2.0	13 B 0	60 N 1	33 B 0	58 N 1	11 B 0	36 N 0	31 B Off	20.50	21.00	2.00	10.0	-
52	Daniel, Massoud	31 0	132	2.0	32 N 0	49 B 0	59 N 1	46 B 1	30 N 0	41 B 0	43 N Off	18.50	20.00	3.50	9.0	-
53	Murrath, Timon	46 0	314	2.0	25 N 0	37 B 0	57 B 1	36 N 0	42 B 0	31 N 0	60 B 1	18.50	19.00	3.00	6.0	-
54	Froyen, Arno	40 0	-201	1.0	7 N 0	23 B 0	26 N 0	40 B 0	64 N 1FF	A	A	20.00	21.00	1.00	3.0	-
55	Kochetkov, Ivan	42 0	478	1.0	8 N 0	45 B 0	61 N 1	A	A	A	A	18.50	20.50	2.00	5.0	-
56	Madwana, Rishabh	44 0	342	1.0	47 N 0	64 B 1	15 N 0	17 B 0	43 N 0	46 B Off	A	18.50	20.00	1.50	6.0	-
57	Deneuille, Elisabeth	34 0	346	1.0	3 N 0	43 B 0	53 N 0	59 B 1	A	A	A	18.00	19.50	1.50	4.0	-
58	Vo, Cindy	63 0	-677	1.0	27 B 0	B1	37 N 0	51 B 0	40 N 0	A	A	17.50	19.50	2.50	6.0	-
59	Kumar, Aryan	43 0	106	1.0	29 B 0	33 N 0	52 B 0	57 N 0	B1	A	A	16.50	17.50	1.00	3.0	-
60	Santiago Solaro, Morrison	54 0	-374	1.0	17 N 0	51 B 0	B1	50 N 0	48 B 0	47 B 0	53 N 0	15.50	17.50	2.00	5.0	-
61	Chalienko, Polina	28 0	-677	0.0	14 B 0	22 N 0	55 B 0	A	A	A	A	17.50	18.50	0.00	0.0	-
62	Diana, Ashim	37 0	1501	0.0	6 B 0	63 N Off	63 N Off	A	A	A	A	17.50	18.50	0.00	0.0	-
63	Roshaanay, Ali	52 0	982	0.0	15 N 0	62 B Off	62 B Off	A	A	A	A	17.00	18.00	0.00	0.0	-
64	Baeke, Elgeo	24 0	-677	0.0	44 B 0	56 N 0	39 B 0	41 N 0	54 B Off	A	A	16.50	17.50	0.00	0.0	-
65	Thong, Wei Jeun	60 0	0	0.0	35 N Off	A	A	A	A	A	A	16.50	17.50	0.00	0.0	-

Résultats du Championnat FSUB d'Escalade (voies)

Entre Ciel & Terre -BLOCRY –
UCLouvain

Samedi 25 mars 2023



Entre Ciel & Terre

OPEN VERTIK TRIP : Classement hommes 16+ (avant la finale)

Championnat FSUB Escalade Lead - Classement surligné en jaune

Classement	Points	Nom/Prenom	Salle/ ecole	Nbre voie
1	2 162	du Bois Simon	UCLouvain Wolves - Université catholique de Louvain	16
2	1 603	BAUDUIN Lionel	UCLouvain Wolves - Université catholique de Louvain	10
3	1 528	ZAFFUTO Hugo	Team camp 4	17
4	1 520	Lempereur Sven	UCLouvain Wolves - Université catholique de Louvain	8
5	1 453	ZEIMES Jim	Escal'pades Arlon	15
6	1 104	Foret Félix	UCLouvain Wolves - Université catholique de Louvain	16
7	972	Quatresooz Sébastien	UCLouvain Wolves - Université catholique de Louvain	12
8	964	LEGAT Antoine	ECT	14
9	958	NEUSER Laurent	GAL	10
10	945	VANDER MEULEN José	ect	15
11	936	Markovsky Stefan	KU Leuven	13
12	926	PRINZ Leopold	Escal pades	12
13	863	ARNOULD Florian	ECT	11
14	768	GENIN Corentin	ECT	15
15	689	Letraublou Hektor	KU Leuven	11
16	672	GUYAUX Pierre	BeBloc	17
17	653	SERRUYS Loïc	ECT	18
18	617	Uyttebroeck Julien	ECT	24
19	607	SAM moray	area escalade	10
20	598	ORVAL Rik	ECT	7
21	549	GUYAUX Jonas	Camp de base	15
22	503	NOIRHOMME laurent	Bebloc	24
23	473	BONNEU Timmie	Gecko tank	16
24	463	CHEVALIER Pierre-Yves	ECT	26
25	443	CARESTIA Gabriel	ETC	13
26	443	caulier Camille	ECT	14
27	428	VAN CALCK Didier	Ect	9
28	421	OLDENHOVE Emmanuel	ECT	8
29	420	Mathieu Nicolas		7
30	417	MASQUELIER Robert	ECT	26
31	384	VANDERHAEGEN Martin Philippe	ECT	9
32	375	HENRARD Arnaud	ECT	16
33	368	Oger Mathéo		10
34	336	CAUDRON Augustin	Abloc	8
35	328	DIENST Vincent	Les potte zoeiper	21
36	300	TURBANG Loïc		22
36	300	VERBEKE Olivier	ECT	22
38	292	VAN LAREBEKE Gauvain	Ect	14
39	290	GALLEZ Xavier	BeBloc	15
40	265	CHUNG Anthony	À BLOC	15
41	239	MANSENS Christophe	ECT	18
42	229	RAMBOUX Arnaud	ECT	13
43	220	JADOT Guillaume		11
44	216	RATEAU Lucas	Salle habituelle	16
45	205	GODFRAIND Nicolas	ECT	18
46	195	HENIN François-Xavier	ECT	12
47	182	MOULAERT Jean-Charles	Terres Neuves	15
48	175	GALLEZ Thomas	ECT	13
49	172	DU BOIS Mathieu	ECT	15
50	171	Mortier Adrien	HELHa - Haute Ecole Louvain en Hainaut	16
51	164	DE WAELE Antonin	ECT	9
52	163	VAN MEERBECK Nicolas	ECT	16
53	148	Laroy Ovidiu	HEPL - Haute Ecole de la Province de Liège	13
54	147	SERVAIS Matéo	ECT	14
55	141	Quentin Rius	HEPL - Haute Ecole de la Province de Liège	12
56	129	OGER Raphaël	Gecko Tank Liège	8
57	123	GUERRY Emilien	ECT	11
58	115	DONNET Aimé	HELHa - Haute Ecole Louvain en Hainaut	11
59	106	PYPART joachim	eski'libre	9
60	106	SOLIS Jorges		11
61	104	ROBILLARD Romuald	Maniak	8
62	104	DUMONT Mathias	ECT	7
63	87	Grosfils Néo	HELHa - Haute Ecole Louvain en Hainaut	8
64	83	Heylen Thomas		8

OPEN VERTIK TRIP : Classement femmes 16+ (avant la finale)

Championnat FSUB Escalade Lead - Classement surligné en jaune

Classement	Points	Nom / Prenom	Salle / Ecole	Nbre voie
1	3 291	KREUSCH Jeanne	ECT	14
2	2 702	SARKANY Muriel		7
3	2 347	GUÉRIT Émilie	ECT	17
4	2 329	de Fays Lorraine Charlotte	ECT	17
5	1 788	PHILIPPART Marie	ECT	14
6	1 555	DE LEUS Siri	ECT	24
7	1 211	Allard Océane Dominique	ECT	8
8	1 148	Desmaré Maëlle	UCLouvain Wolves - Université catholique de Louvain	20
9	1 077	Paque Ysaline	UCLouvain Wolves - Université catholique de Louvain	24
10	1 024	CUIGNET Laure	Stone age	11
11	862	DELSAUX Claudine	Gecko tank	16
12	756	VANDERPYPEN Leila	ECT	16
13	737	Dossogne Agathe	UCLouvain Wolves - Université catholique de Louvain	14
14	690	Roevens Febe	KU Leuven	15
15	679	Deruwe Liedewij	KU Leuven	12
16	452	SAMSON Charlotte	ECT	6
17	446	LAURENT HIMMER Maricielo	HELHa - Haute Ecole Louvain en Hainaut	17
17	446	LAURENT HIMMER Marisol	HELHa - Haute Ecole Louvain en Hainaut	17
19	405	MARCHAND Margot	Eskilibre	11
20	352	VAN DYCK Dorine	Terres Neuves	15
21	332	RATEAU Emilie	Salle habituelle	14
22	303	MATTHEWS Victoria	ECT	16
23	269	Fauvillon Emma	HELHa - Haute Ecole Louvain en Hainaut	14
24	258	Charlotte rodriguez		10
25	232	Hainaut Clara	HEPH-Condorcet - Haute Ecole Provinciale du Hainaut - Condorcet	9
26	222	METTLER Marie	ECT	13
27	204	FUNCKEN Laura Marie		10
28	201	Aubert Clara	HEPL - Haute Ecole de la Province de Liège	10
29	138	Ribot Chloé	HEPL - Haute Ecole de la Province de Liège	9
30	130	FOIDART Valentine Caroline	Eskilibre	6
31	130	Everaert Célia		6
32	116	HANSSENS Maya		7
33	103	DETHIER Lucie	ECT	6
34	99	Pfister Léonie	HELHa - Haute Ecole Louvain en Hainaut	7
35	97	WELSBY Emily	ECT	7
36	86	Van der Heiden Edwige	ECT	7
37	85	Renault Delescluse Valentine	HEPL - Haute Ecole de la Province de Liège	7

PODIUM Femmes Vertik Trip (après la finale)

1	KREUSCH Jeanne		
2	SARKANY Muriel		
3	DE LEUS Siri		

PODIUM Femmes Championnat universitaire

1	Desmaré Maëlle	UCLouvain Wolves - Université catholique de Louvain	
2	Paque Ysaline	UCLouvain Wolves - Université catholique de Louvain	
3	Dossogne Agathe	UCLouvain Wolves - Université catholique de Louvain	

Résultats du Championnat FSUB d'Escrime

Club des « 3 armes » à Gembloux

Salle des Sports de l'Ecole Horticole

Samedi 11 février 2023

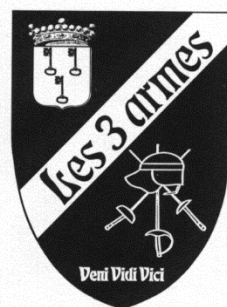

Résultats du championnat FSUB d'Écime

Samedi 11 février 2023 à Gembloux

Épée Hommes

Overall ranking

Rank		Club	Nation
1)	HANSENNE Arian	U.GENT	BEL
2)	BAUWELINCK Briecq	U.GENT	BEL
3)	VANDENHAUTE Lars	U.GENT	BEL
4)	FRANCOTTE Maxime	V.U.BRUSSEL	BEL
5)	VANHASSEL Andre	THOMAS MORE KEMPEN	BEL
6)	BOITTE Loic	U.MONS	BEL
7)	ROESBEKE Steffen	E.R.M. K.M.S	BEL
8)	GASI Albrin	U.ANTWERPEN	BEL
9)	CORDIER Brice	U.MONS	BEL
10)	ABADJENE Kossi	U.MONS	BEL
11)	PIERLOT Alexandre	U.C.LOUVAIN	BEL
12)	GHISLAIN Maxime	E.R.M. K.M.S	BEL
13)	RAZANAJAO Aina	U.MONS	BEL
14)	GILLET Antoine	U.NAMUR	BEL
15)	MARICHAL Gaetan	U.LIEGE	BEL

Sabre Hommes

Overall ranking

Rank		Club	Nation
1)	JACQUES Philippe	U.C.LOUVAIN	BEL
2)	POIZAT Adrien	U.LIÈGE	BEL
3)	VANQUAETHOVEN Brecht	HOEGESCHOO LPXL	BEL
4)	THIELEMANS Alain	V.U.BRUSSEL	BEL
5)	STEINFORT Jules	U.C.LOUVAIN	BEL
6)	VAN HECKE Duarte	ODISEE HOGESCHOOL	BEL
7)	DANIILS SIDOROV'S Iva.	K.U.LEUVEN	BEL
8)	SCHREIDEN Noé	U.LIÈGE	BEL
9)	DAUCHAT Liam	U.C.LOUVAIN	BEL
10)	BERTELOOT Brecht	K.U.LEUVEN	BEL

Fleuret Hommes

Overall ranking

Rank		Club	Nation
1)	LEONARD Alexandre	H.E.PLIÈGE	BEL
2)	FAUCONNIER Basile	U.LIEGE	BEL
3)	GASPERINI Loïc	H.E.PLIÈGE	BEL
4)	VANDER ELST Julien	U.SAINT LOUIS BRUXE.	BEL
5)	LAGUNA AGUIREZ Vince.	U.C.LOUVAIN	BEL
6)	COPPIETERS Thomas	U.C.LOUVAIN	BEL
7)	VERSTEGEN Zeger	E.R.M. K.M.S.	BEL

Épée Dames

Overall ranking

Rank		Club	Nation
1)	DE CLERCK Noa	U.GENT	BEL
2)	HABRAN Emeline	H.E.VINCI	BEL
3)	LABRO Emma1	K.U.LEUVEN	BEL
4)	VERCAUTEREN Bieke	K.U.LEUVEN	BEL
5)	STEURBAUT Romane	K.U.LEUVEN	BEL
6)	LELEU Margaux	U.NAMUR	BEL
7)	LENSSENS Anke	U.GENT	BEL

Tous les résultats disponibles sur :

<https://engarde-service.com/siteTemplate.php?lang=fr&Organisme=les3armes&Event=cbu23&page=competitions.php>

Sabre Dames

Overall ranking

Rank		Club	Nation
1)	FONDEUR Apolline	U.C.LOUVAIN	BEL
2)	NAPOLITANO Lucie	U.LIÈGE	BEL
3)	AELVOET Floriane	ARTEVELEHOGESCHOOL	BEL
4)	PONCIN Auriane	U.LIÈGE	BEL
5)	DERDE Helene	U.GENT	BEL
6)	MINNE Romane	U.LIÈGE	BEL
7)	SONDERVORST Kaat	K.U.LEUVEN	BEL
8)	DE PAEPE Olivia	K.U.LEUVEN	BEL

Fleuret Dames

Overall ranking

Rank		Club	Nation
1)	CHARLIER Amandine	H.Z.ANTWERPEN	BEL
2)	REINBOLD Mahaut	U.C.LOUVAIN	BEL
3)	JORDENS Heloise	U.NAMUR	BEL
4)	GORNY Raphelle	U.LIEGE	BEL
5)	DRYBOOMS Manon	HENALLUX	BEL
6)	DACO Sophie	U.C.LOUVAIN	BEL
7)	DUPONT Appoline	U.C.LOUVAIN	BEL
8)	SION Marie	U.C.LOUVAIN	BEL
9)	COLIGNON Marie	U.C.LOUVAIN	BEL
10)	GOHIER Emerance	U.C.LOUVAIN	BEL

Résultats du Championnat FSUB de Gymnastique

BLOCRY – UCLouvain

Lundi 13 mars 2023



Résultats concours individuel

Place	Dos	Nom	Unif	Saut	Barres	Poutre	Sol	Total
1	11	Kohnenmergem Emma	UCLouvain1	12,200	12,533	12,767	12,967	50,467
2	28	Milioto Ilona	HeVINC11	12,250	11,400	12,533	12,833	49,017
3	34	Goffard Célia	HEPL	11,800	12,033	11,433	11,733	47,000
4	41	Palermi Sarah	ULiège	11,550	12,267	11,267	11,333	46,417
5	20	Grommech Manon	Helmo	12,000	11,233	11,267	11,833	46,333
6	42	Sturbois Emelyne	ULiège	11,800	10,700	12,767	10,733	46,000
7	10	Dumont Elise	UCLouvain1	11,400	11,667	10,133	12,467	45,667
8	5	Renaud Laura	UCLouvain2	10,400	11,033	12,333	11,633	45,400
9	12	Renders Wendy	UCLouvain1	11,600	8,900	12,000	12,200	44,700
10	13	Simon Charlotte	UCLouvain1	11,650	9,967	11,033	11,900	44,550
11	7	Van Caenegem Elise	UCLouvain2	12,250	9,700	11,033	10,933	43,917
12	19	Van Deyck Meredith	KULeuven	11,500	10,233	9,033	11,267	42,033
13	29	Thomas Elisa	HeVINC11	11,850	9,267	8,267	11,633	41,017
14	30	Jadot Emilie	HeVINC12	11,300	8,233	10,067	10,833	40,433
15	27	Leyder Juliette	HeVINC11	10,550	9,600	8,600	10,900	39,650
16	23	Thyssens Morgane	ULB Owls	10,400	9,800	9,067	10,067	39,333
17	40	Odobescu Odile	ULiège	10,450	8,567	10,167	10,133	39,317
18	25	Bruyeer Sabine	HeVINC11	10,450	8,767	8,933	11,067	39,217
19	16	Lecomte Adélaïde	KULeuven	10,550	7,200	9,833	9,900	37,483
20	22	Van Caenegem Maëlle	UCLouv. Ind	10,200	6,933	9,733	10,100	36,967
21	31	Legrand Clémence	HeVINC12	11,100	6,567	8,067	10,833	36,567
22	33	Belche Otilie	HEPL	10,550	6,900	7,633	9,967	35,050
23	39	Maurel Solenne	ULiège	11,700	12,200	10,700	0,000	34,600
24	9	Damri Neïla	UCLouvain1	0,000	9,000	12,533	12,300	33,833
25	3	Michiels Sophie	UCLouvain2	11,950	9,733	0,000	11,633	33,317
26	35	Patry Camille	HEPL	9,700	6,467	7,700	8,333	32,200
27	21	Aulotte Enola	UCLouv. Ind	10,650	6,200	0,000	9,633	26,483
28	32	Rodriguez Laura	HeVINC12	9,950	0,000	6,467	8,567	24,983
29	2	Gronemberger Eléa	UCLouvain2	11,750	11,033	0,000	0,000	22,783
30	4	Nachtergaele Marie	UCLouvain2	0,000	0,000	10,133	11,000	21,133
31	6	Tasiaux Laurine	UCLouvain2	0,000	9,600	9,767	0,000	19,367
32	1	Back Natalia	UCLouvain2	10,400	0,000	8,367	0,000	18,767
33	15	Ghys Fran	KULeuven	0,000	7,833	10,700	0,000	18,533
34	18	Van Deyck Emoa	KULeuven	0,000	0,000	6,833	7,867	14,700
35	26	Jacqmin Camille	HeVINC11	0,000	12,800	0,000	0,000	12,800
36	8	Crefcoeur Leslie	UCLouvain1	11,950	0,000	0,000	0,000	11,950
37	38	Jacques Marie	ULiège	0,000	0,000	0,000	10,333	10,333
38	36	Gendebien Charlotte	ULiège	0,000	0,000	0,000	10,233	10,233
39	37	Grondal Zoé	ULiège	0,000	7,200	0,000	0,000	7,200
40	24	Rommers Hannah	Arteveldehoges	0,000	0,000	0,000	0,000	0,000
41	17	Neyrinck Margot	KULeuven	0,000	0,000	0,000	0,000	0,000
42	14	Aerts Mia	KULeuven	0,000	0,000	0,000	0,000	0,000

Résultats concours par équipe

1	Dos	Nom	Unif	Saut	Barres	Poutre	Sol	
	8	Crefcoeur Leslie	UCLouvain1	11,950	0,000	0,000	0,000	
	9	Damri Neïla	UCLouvain1	0,000	9,000	12,533	12,300	
	10	Dumont Elise	UCLouvain1	11,400	11,667	10,133	12,467	
	11	Kohnenmergem Emma	UCLouvain1	12,200	12,533	12,767	12,967	
	12	Renders Wendy	UCLouvain1	11,600	8,900	12,000	12,200	
	13	Simon Charlotte	UCLouvain1	11,650	9,967	11,033	11,900	
				35,800	34,167	37,300	37,733	145

2	Dos	Nom	Unif	Saut	Barres	Poutre	Sol	
	36	Gendebien Charlotte	ULiège	0,000	0,000	0,000	10,233	
	37	Grondal Zoé	ULiège	0,000	7,200	0,000	0,000	
	38	Jacques Marie	ULiège	0,000	0,000	0,000	10,333	
	39	Maurel Solenne	ULiège	11,700	12,200	10,700	0,000	
	40	Odobescu Odile	ULiège	10,450	8,567	10,167	10,133	
	41	Palermi Sarah	ULiège	11,550	12,267	11,267	11,333	
	42	Sturbois Emelyne	ULiège	11,800	10,700	12,767	10,733	
				35,050	35,167	34,733	32,400	137,350

3	Dos	Nom	Unif	Saut	Barres	Poutre	Sol	
	1	Back Natalia	UCLouvain2	10,400	0,000	8,367	0,000	
	2	Gronemberger Eléa	UCLouvain2	11,750	11,033	0,000	0,000	
	3	Michiels Sophie	UCLouvain2	11,950	9,733	0,000	11,633	
	4	Nachtergaele Marie	UCLouvain2	0,000	0,000	10,133	11,000	
	5	Renaud Laura	UCLouvain2	10,400	11,033	12,333	11,633	
	6	Tasiaux Laurine	UCLouvain2	0,000	9,600	9,767	0,000	
	7	Van Caenegem Elise	UCLouvain2	12,250	9,700	11,033	10,933	
				35,950	31,800	33,500	34,267	135,517

4	Dos	Nom	Unif	Saut	Barres	Poutre	Sol	
	25	Bruyeer Sabine	HeVINC11	10,450	8,767	8,933	11,067	
	26	Jacqmin Camille	HeVINC11	0,000	12,800	0,000	0,000	
	27	Leyder Juliette	HeVINC11	10,550	9,600	8,600	10,900	
	28	Milioto Ilona	HeVINC11	12,250	11,400	12,533	12,833	
	29	Thomas Elisa	HeVINC11	11,850	9,267	8,267	11,633	
				34,650	33,800	30,067	35,533	134,050

5	Dos	Nom	Unif	Saut	Barres	Poutre	Sol	
	33	Belche Otilie	HEPL	10,550	6,900	7,633	9,967	
	34	Goffard Célia	HEPL	11,800	12,033	11,433	11,733	
	35	Patry Camille	HEPL	9,700	6,467	7,700	8,333	
				32,050	25,400	26,767	30,033	114,250

6	Dos	Nom	Unif	Saut	Barres	Poutre	Sol	
	14	Aerts Mia	KULeuven	10,6	7,433333	0	0	
	15	Ghys Fran	KULeuven	0	7,833333	10,7	0	
	16	Lecomte Adélaïde	KULeuven	10,55	7,2	9,833333	9,9	
	17	Neyrinck Margot	KULeuven	0	0	0	0	
	18	Van Deyck Emoa	KULeuven	0	0	6,833333	7,866667	
	19	Van Deyck Meredith	KULeuven	11,5	10,23333	9,033333	11,26667	
				32,65	25,5	29,56667	17,76667	105,4833

7	Dos	Nom	Unif	Saut	Barres	Poutre	Sol	
	30	Jadot Emilie	HeVINC12	11,300	8,233	10,067	10,833	
	31	Legrand Clémence	HeVINC12	11,100	6,567	8,067	10,833	
	32	Rodriguez Laura	HeVINC12	9,950	0,000	6,467	8,567	
				32,350	14,800	24,600	30,233	101,983

Place	Dos	Nom	Unif	Saut
1	7	Van Caenegem Elise	UCLouvain2	12,250
1	28	Milioto Ilona	HeVINC11	12,250
3	11	Kohnenmergem Emma	UCLouvain1	12,200
4	20	Grommech Manon	Helmo	12,000
5	3	Michiels Sophie	UCLouvain2	11,950
5	8	Crefcoeur Leslie	UCLouvain1	11,950
7	29	Thomas Elisa	HeVINC11	11,850
8	34	Goffard Célia	HEPL	11,800
8	42	Sturbois Emelyne	ULiège	11,800
10	2	Gronemberger Eléa	UCLouvain2	11,750
11	39	Maurel Solenne	ULiège	11,700
12	13	Simon Charlotte	UCLouvain1	11,650
13	12	Renders Wendy	UCLouvain1	11,600
14	41	Palermi Sarah	ULiège	11,550
15	19	Van Deyck Meredith	KULeuven	11,500
16	10	Dumont Elise	UCLouvain1	11,400
17	30	Jadot Emilie	HeVINC12	11,300
18	31	Legrand Clémence	HeVINC12	11,100
19	21	Aulotte Enola	UCLouv. Ind	10,650
20	14	Aerts Mia	KULeuven	10,600
21	33	Belche Otilie	HEPL	10,550
21	16	Lecomte Adélaïde	KULeuven	10,550
21	27	Leyder Juliette	HeVINC11	10,550
24	25	Bruyeer Sabine	HeVINC11	10,450
24	40	Odobescu Odile	ULiège	10,450
26	5	Renaud Laura	UCLouvain2	10,400
26	1	Back Natalia	UCLouvain2	10,400
28	23	Thyssens Morgane	ULB Owls	10,400
29	22	Van Caenegem Maëlle	UCLouv. Ind	10,200
30	32	Rodriguez Laura	HeVINC12	9,950
31	35	Patry Camille	HEPL	9,700
32	4	Nachtergaele Marie	UCLouvain2	0,000
33	6	Tasiaux Laurine	UCLouvain2	0,000
34	9	Damri Neïla	UCLouvain1	0,000
35	15	Ghys Fran	KULeuven	0,000
36	17	Neyrinck Margot	KULeuven	0,000
37	18	Van Deyck Emoa	KULeuven	0,000
38	24	Rommers Hannah	Arteveldehoges	0,000
39	26	Jacqmin Camille	HeVINC11	0,000
40	36	Gendebien Charlotte	ULiège	0,000
41	37	Grondal Zoé	ULiège	0,000
42	38	Jacques Marie	ULiège	0,000

Place	Dos	Nom	Unif	Barres
1	26	Jacqmin Camille	HeVINC11	12,800
2	11	Kohnenmergem Emma	UCLouvain1	12,533
3	41	Palermi Sarah	ULiège	12,267
4	39	Maurel Solenne	ULiège	12,200
5	34	Goffard Célia	HEPL	12,033
6	10	Dumont Elise	UCLouvain1	11,667
7	28	Milioto Ilona	HeVINC11	11,400
8	20	Grommech Manon	Helmo	11,233
9	2	Gronemberger Eléa	UCLouvain2	11,033
9	5	Renaud Laura	UCLouvain2	11,033
11	42	Sturbois Emelyne	ULiège	10,700
12	19	Van Deyck Meredith	KULeuven	10,233
13	13	Simon Charlotte	UCLouvain1	9,967
14	23	Thyssens Morgane	ULB Owls	9,800
15	3	Michiels Sophie	UCLouvain2	9,733
16	7	Van Caenegem Elise	UCLouvain2	9,700
17	6	Tasiaux Laurine	UCLouvain2	9,600
17	27	Leyder Juliette	HeVINC11	9,600
19	29	Thomas Elisa	HeVINC11	9,267
20	9	Damri Neïla	UCLouvain1	9,000
21	12	Renders Wendy	UCLouvain1	8,900
22	25	Bruyeer Sabine	HeVINC11	8,767
23	40	Odobescu Odile	ULiège	8,567
24	30	Jadot Emilie	HeVINC12	8,233
25	15	Ghys Fran	KULeuven	7,833
26	14	Aerts Mia	KULeuven	7,433
27	16	Lecomte Adélaïde	KULeuven	7,200
27	37	Grondal Zoé	ULiège	7,200
29	22	Van Caenegem Maëlle	UCLouv. Ind	6,933
30	33	Belche Otilie	HEPL	6,900
31	31	Legrand Clémence	HeVINC12	6,567
32	35	Patry Camille	HEPL	6,467
33	21	Aulotte Enola	UCLouv. Ind	6,200
34	1	Back Natalia	UCLouvain2	0,000
35	4	Nachtergaele Marie	UCLouvain2	0,000
36	8	Crefcoeur Leslie	UCLouvain1	0,000
37	17	Neyrinck Margot	KULeuven	0,000
38	18	Van Deyck Emoa	KULeuven	0,000
39	24	Rommers Hannah	Arteveldehoges	0,000
40	32	Rodriguez Laura	HeVINC12	0,000
41	36	Gendebien Charlotte	ULiège	0,000
42	38	Jacques Marie	ULiège	0,000

Place	Dos	Nom	Unif	Poutre
1	11	Kohnenmergem Emma	UCLouvain1	12,767
1	42	Sturbois Emelyne	ULiège	12,767
3	9	Damri Neïla	UCLouvain1	12,533
3	28	Milioto Ilona	HeVINC1	12,533
5	5	Renaud Laura	UCLouvain2	12,333
6	12	Renders Wendy	UCLouvain1	12,000
7	34	Goffard Célia	HEPL	11,433
8	20	Grommech Manon	Helmo	11,267
8	41	Palermi Sarah	ULiège	11,267
10	7	Van Caenegem Elise	UCLouvain2	11,033
10	13	Simon Charlotte	UCLouvain1	11,033
12	15	Ghys Fran	KULeuven	10,700
12	39	Maurel Solenne	ULiège	10,700
14	40	Odobescu Odile	ULiège	10,167
15	4	Nachtergaele Marie	UCLouvain2	10,133
15	10	Dumont Elise	UCLouvain1	10,133
17	30	Jadot Emilie	HeVINC12	10,067
18	16	Lecomte Adélaïde	KULeuven	9,833
19	6	Tasiaux Laurine	UCLouvain2	9,767
20	22	Van Caenegem Maëlle	UCLouv. Ind	9,733
21	23	Thyssens Morgane	ULB Ows	9,067
22	19	Van Deyck Meredith	KULeuven	9,033
23	25	Bruyeer Sabine	HeVINC1	8,933
24	27	Leyder Juliette	HeVINC1	8,600
25	1	Back Natalia	UCLouvain2	8,367
26	29	Thomas Elisa	HeVINC1	8,267
27	31	Legrand Clémence	HeVINC12	8,067
28	35	Patry Camille	HEPL	7,700
29	33	Belche Otilie	HEPL	7,633
30	18	Van Deyck Emoa	KULeuven	6,833
31	32	Rodriguez Laura	HeVINC12	6,467
32	2	Gronemberger Eléa	UCLouvain2	0,000
33	3	Michiels Sophie	UCLouvain2	0,000
34	8	Crefcoeur Leslie	UCLouvain1	0,000
35	14	Aerts Mia	KULeuven	0,000
36	17	Neyrinck Margot	KULeuven	0,000
37	21	Aulotte Enola	UCLouv. Ind	0,000
38	24	Rommers Hannah	Arteveldehoges	0,000
39	26	Jacqmin Camille	HeVINC1	0,000
40	36	Gendebien Charlotte	ULiège	0,000
41	37	Grondal Zoé	ULiège	0,000
42	38	Jacques Marie	ULiège	0,000

Place	Dos	Nom	Unif	Sol
1	11	Kohnenmergem Emma	UCLouvain1	12,967
2	28	Milioto Ilona	HeVINC11	12,833
3	10	Dumont Elise	UCLouvain1	12,467
4	9	Damri Neïla	UCLouvain1	12,300
5	12	Renders Wendy	UCLouvain1	12,200
6	13	Simon Charlotte	UCLouvain1	11,900
7	20	Grommech Manon	Helmo	11,833
8	34	Goffard Célia	HEPL	11,733
9	3	Michiels Sophie	UCLouvain2	11,633
9	5	Renaud Laura	UCLouvain2	11,633
9	29	Thomas Elisa	HeVINC11	11,633
12	41	Palermi Sarah	ULiège	11,333
13	19	Van Deyck Meredith	KULeuven	11,267
14	25	Bruyeer Sabine	HeVINC11	11,067
15	4	Nachtergaele Marie	UCLouvain2	11,000
16	7	Van Caenegem Elise	UCLouvain2	10,933
17	27	Leyder Juliette	HeVINC11	10,900
18	30	Jadot Emilie	HeVINC12	10,833
18	31	Legrand Clémence	HeVINC12	10,833
20	42	Sturbois Emelyne	ULiège	10,733
21	38	Jacques Marie	ULiège	10,333
22	36	Gendebien Charlotte	ULiège	10,233
23	40	Odobescu Odile	ULiège	10,133
24	22	Van Caenegem Maëlle	UCLouv. Ind	10,100
25	23	Thyssens Morgane	ULB Ows	10,067
26	33	Belche Otilie	HEPL	9,967
27	16	Lecomte Adélaïde	KULeuven	9,900
28	21	Aulotte Enola	UCLouv. Ind	9,633
29	32	Rodriguez Laura	HeVINC12	8,567
30	35	Patry Camille	HEPL	8,333
31	18	Van Deyck Emoa	KULeuven	7,867
32	1	Back Natalia	UCLouvain2	0,000
33	2	Gronemberger Eléa	UCLouvain2	0,000
34	6	Tasiaux Laurine	UCLouvain2	0,000
35	8	Crefcoeur Leslie	UCLouvain1	0,000
36	14	Aerts Mia	KULeuven	0,000
37	15	Ghys Fran	KULeuven	0,000
38	17	Neyrinck Margot	KULeuven	0,000
39	24	Rommers Hannah	Arteveldehoges	0,000
40	26	Jacqmin Camille	HeVINC11	0,000
41	37	Grondal Zoé	ULiège	0,000
42	39	Maurel Solenne	ULiège	0,000

Résultats concours par équipe

1	Dos	Nom	Unif	Sol	Arçons	Anneaux	Saut	Barres	Rek	
	45	Cassart Mathéo	UCLouvain	0,00	0,00	11,60	0,00	11,30	0,00	
	46	Debecker Antoine	UCLouvain	0,00	4,15	0,00	0,00	0,00	8,50	
	47	Van Dyck Nathan	UCLouvain	11,70	0,00	0,00	11,60	0,00	0,00	
	48	Wiseur Marceau	UCLouvain	13,35	11,45	13,60	10,95	11,80	10,65	
	49	Wiseur Maxence	UCLouvain	12,05	12,50	12,50	11,45	11,50	11,95	
	50	Wiseur Valentin	UCLouvain	12,20	11,80	12,15	12,20	11,70	11,45	
				37,60	35,75	38,25	35,25	35,00	34,05	215,90

2	Dos	Nom	Unif	Sol	Arçons	Anneaux	Saut	Barres	Rek	
	55	Caponi Matteo	KU Leuven	12,95	10,05	12,95	10,25	12,10	12,65	
	56	Devaere Vic	KU Leuven	11,60	0,00	0,00	10,00	10,85	0,00	
	57	Doobels Christophe	KU Leuven	0,00	9,90	0,00	0,00	0,00	6,40	
	58	Schellens Juul	KU Leuven	11,25	9,80	7,75	0,00	10,80	0,00	
	59	Steenhouwer Arne	KU Leuven	12,95	0,00	11,20	11,90	0,00	10,85	
				37,50	29,75	31,90	32,15	33,75	29,90	194,95

3	Dos	Nom	Unif	Sol	Arçons	Anneaux	Saut	Barres	Rek	
	60	Bairy Benjamin	HEVinci	0,00	2,50	4,85	0,00	0,00	0,00	
	61	Cuypers Florian	HEVinci	0,00	0,00	0,00	0,00	0,00	0,00	
	62	Delbecque Yvan	HEVinci	8,10	0,00	7,10	9,70	6,70	6,40	
	63	Mirabile Mattias	HEVinci	9,90	4,20	0,00	9,85	0,00	7,95	
	64	Saucez Xidi	HEVinci	0,00	0,00	0,00	0,00	0,00	0,00	
	65	Straus Lucien	HEVinci	0,00	0,00	6,75	0,00	5,70	2,85	
	66	Thibaut Baptiste	HEVinci	7,85	5,75	6,55	10,25	7,30	0,00	
				25,85	12,45	20,40	29,80	19,70	17,20	125,40

Place	Dos	Nom	Unif	Sol
1	52	Seghers Antoine	ULB	14,70
2	53	Leemans Andi	VUB	13,50
3	48	Wiseur Marceau	UCLouvain	13,35
4	55	Caponi Matteo	KU Leuven	12,95
4	59	Steenhouwer Arne	KU Leuven	12,95
6	51	Debehogne Cyril	ULB	12,25
7	50	Wiseur Valentin	UCLouvain	12,20
8	49	Wiseur Maxence	UCLouvain	12,05
9	47	Van Dyck Nathan	UCLouvain	11,70
10	56	Devaere Vic	KU Leuven	11,60
11	58	Schellens Juul	KU Leuven	11,25
12	63	Mirabile Mattias	HEVinci	9,90
13	62	Delbecque Yvan	HEVinci	8,10
14	66	Thibaut Baptiste	HEVinci	7,85
15	45	Cassart Mathéo	UCLouvain	0,00
16	46	Debecker Antoine	UCLouvain	0,00
17	54	Van Lomberghe Michiel	Universiteit G	0,00
18	57	Doobels Christophe	KU Leuven	0,00
19	60	Bairy Benjamin	HEVinci	0,00
20	61	Cuypers Florian	HEVinci	0,00
21	64	Saucez Xidi	HEVinci	0,00
22	65	Straus Lucien	HEVinci	0,00

Place	Dos	Nom	Unif	Arçons
1	49	Wiseur Maxence	UCLouvain	12,50
2	50	Wiseur Valentin	UCLouvain	11,80
3	48	Wiseur Marceau	UCLouvain	11,45
4	53	Leemans Andi	VUB	11,25
5	52	Seghers Antoine	ULB	10,20
6	55	Caponi Matteo	KU Leuven	10,05
7	57	Doobels Christophe	KU Leuven	9,90
8	58	Schellens Juul	KU Leuven	9,80
9	51	Debehogne Cyril	ULB	9,10
10	66	Thibaut Baptiste	HEVinci	5,75
11	63	Mirabile Mattias	HEVinci	4,20
12	46	Debecker Antoine	UCLouvain	4,15
13	60	Bairy Benjamin	HEVinci	2,50
14	45	Cassart Mathéo	UCLouvain	0,00
15	47	Van Dyck Nathan	UCLouvain	0,00
16	54	Van Lomberghen Michiel	Universiteit G	0,00
17	56	Devaere Vic	KU Leuven	0,00
18	59	Steenhouwer Arne	KU Leuven	0,00
19	61	Cuypers Florian	HEVinci	0,00
20	62	Delbecque Yvan	HEVinci	0,00
21	64	Saucez Xidi	HEVinci	0,00
22	65	Straus Lucien	HEVinci	0,00

Place	Dos	Nom	Unif	Anneaux
1	48	Wiseur Marceau	UCLouvain	13,60
2	55	Caponi Matteo	KU Leuven	12,95
3	53	Leemans Andi	VUB	12,80
4	52	Seghers Antoine	ULB	12,55
5	49	Wiseur Maxence	UCLouvain	12,50
6	50	Wiseur Valentin	UCLouvain	12,15
7	51	Debehogne Cyril	ULB	11,75
8	45	Cassart Mathéo	UCLouvain	11,60
9	59	Steenhouwer Arne	KU Leuven	11,20
10	58	Schellens Juul	KU Leuven	7,75
11	62	Delbecque Yvan	HEVinci	7,10
12	65	Straus Lucien	HEVinci	6,75
13	66	Thibaut Baptiste	HEVinci	6,55
14	60	Bairy Benjamin	HEVinci	4,85
15	46	Debecker Antoine	UCLouvain	0,00
16	47	Van Dyck Nathan	UCLouvain	0,00
17	54	Van Lomberghe Michiel	Universiteit G	0,00
18	56	Devaere Vic	KU Leuven	0,00
19	57	Doobels Christophe	KU Leuven	0,00
20	61	Cuypers Florian	HEVinci	0,00
21	63	Mirabile Mattias	HEVinci	0,00
22	64	Saucez Xidi	HEVinci	0,00

Place	Dos	Nom	Unif	Saut
1	53	Leemans Andi	VUB	12,25
2	50	Wiseur Valentin	UCLouvain	12,20
3	59	Steenhouwer Arne	KU Leuven	11,90
4	47	Van Dyck Nathan	UCLouvain	11,60
5	49	Wiseur Maxence	UCLouvain	11,45
6	48	Wiseur Marceau	UCLouvain	10,95
7	51	Debehogne Cyril	ULB	10,90
8	52	Seghers Antoine	ULB	10,45
9	55	Caponi Matteo	KU Leuven	10,25
10	66	Thibaut Baptiste	HEVinci	10,25
11	63	Mirabile Mattias	HEVinci	9,85
12	62	Delbecque Yvan	HEVinci	9,70
13	56	Devaere Vic	KU Leuven	9,70
14	60	Bairy Benjamin	HEVinci	0,00
15	61	Cuypers Florian	HEVinci	0,00
16	65	Straus Lucien	HEVinci	0,00
17	45	Cassart Mathéo	UCLouvain	0,00
18	46	Debecker Antoine	UCLouvain	0,00
19	54	Van Lomberghen Michiel	Universiteit G	0,00
20	57	Doobels Christophe	KU Leuven	0,00
21	58	Schellens Juul	KU Leuven	0,00
22	64	Saucez Xidi	HEVinci	0,00

Place	Dos	Nom	Unif	Barres
1	53	Leemans Andi	VUB	12,55
2	55	Caponi Matteo	KU Leuven	12,10
3	48	Wiseur Marceau	UCLouvain	11,80
4	50	Wiseur Valentin	UCLouvain	11,70
5	49	Wiseur Maxence	UCLouvain	11,50
6	45	Cassart Mathéo	UCLouvain	11,30
6	51	Debehogne Cyril	ULB	11,30
8	56	Devaere Vic	KU Leuven	10,85
9	58	Schellens Juul	KU Leuven	10,80
10	52	Seghers Antoine	ULB	9,30
11	66	Thibaut Baptiste	HEVinci	7,30
12	62	Delbecque Yvan	HEVinci	6,70
13	65	Straus Lucien	HEVinci	5,70
14	46	Debecker Antoine	UCLouvain	0,00
15	47	Van Dyck Nathan	UCLouvain	0,00
16	54	Van Lomberghe Michiel	Universiteit G	0,00
17	57	Doobels Christophe	KU Leuven	0,00
18	59	Steenhouwer Arne	KU Leuven	0,00
19	60	Bairy Benjamin	HEVinci	0,00
20	61	Cuyper Florian	HEVinci	0,00
21	63	Mirabile Mattias	HEVinci	0,00
22	64	Saucez Xidi	HEVinci	0,00

Place	Dos	Nom	Unif	Rek
1	52	Seghers Antoine	ULB	12,70
2	55	Caponi Matteo	KU Leuven	12,65
3	49	Wiseur Maxence	UCLouvain	11,95
4	53	Leemans Andi	VUB	11,90
5	50	Wiseur Valentin	UCLouvain	11,45
6	59	Steenhouwer Arne	KU Leuven	10,85
7	48	Wiseur Marceau	UCLouvain	10,65
8	51	Debehogne Cyril	ULB	10,25
9	46	Debecker Antoine	UCLouvain	8,50
10	63	Mirabile Mattias	HEVinci	7,95
11	57	Doobels Christophe	KU Leuven	6,40
12	62	Delbecque Yvan	HEVinci	6,40
13	65	Straus Lucien	HEVinci	2,85
14	45	Cassart Mathéo	UCLouvain	0,00
15	47	Van Dyck Nathan	UCLouvain	0,00
16	54	Van Lomberghe Michiel	Universiteit G	0,00
17	56	Devaere Vic	KU Leuven	0,00
18	58	Schellens Juul	KU Leuven	0,00
19	60	Bairy Benjamin	HEVinci	0,00
20	61	Cuypers Florian	HEVinci	0,00
21	64	Saucez Xidi	HEVinci	0,00
22	66	Thibaut Baptiste	HEVinci	0,00

Résultats du Championnat FSUB
de Judo Individuel
Salle de l'UMONS
Mercredi 7 décembre 2022



FSUB Judo Championship 07/12/2022 D-57

Competitors: 3

Competitors

#	Name	Club	1	2	3	Wins	Pts	Pos
1	MARIE OSTER (?) UMONS Dragons - Université de			0	10	1	10	2
2	CHLOÉ BIERNAUX (?) UMONS Dragons - Université de		10		10	2	20	1
3	ORIANE DATH (?) UCLouvain Wolves - Université		0	0		0	0	3

Matches

Match	White			Blue	Result	Time
1	MARIE OSTER	1	2	CHLOÉ BIERNAUX	0 - 10	1:30
2	MARIE OSTER	1	3	ORIANE DATH	10 - 0	3:15
3	CHLOÉ BIERNAUX	2	3	ORIANE DATH	10 - 0	0:06

Results

Pos	Name
1	CHLOÉ BIERNAUX UMONS Dragons - Université de
2	MARIE OSTER UMONS Dragons - Université de
3	ORIANE DATH UCLouvain Wolves - Université

B.U.S.F. - F.S.U.B.



FSUB Judo Championship 07/12/2022 D-63

Competitors: 3

Competitors

#	Name	Club	1	2	3	Wins	Pts	Pos
1	CELIA JAMAR (?) ULiège (Liège) - Université de			0	10	1	10	2
2	EVA NAGY (?) HELMo - Haute Ecole Libre Mosa		10		10	2	20	1
3	ENORA DEMOULIN (?) UCLouvain Wolves - Université		0	0		0	0	3

Matches

Match	White			Blue	Result	Time
1	CELIA JAMAR	1	2	EVA NAGY	0 - 10	2:39
2	CELIA JAMAR	1	3	ENORA DEMOULIN	10 - 0	1:04
3	EVA NAGY	2	3	ENORA DEMOULIN	10 - 0	0:47

Results

Pos	Name
1	EVA NAGY HELMo - Haute Ecole Libre Mosa
2	CELIA JAMAR ULiège (Liège) - Université de
3	ENORA DEMOULIN UCLouvain Wolves - Université

B.U.S.F. - F.S.U.B.



FSUB Judo Championship 07/12/2022 D-70



Competitors: 7

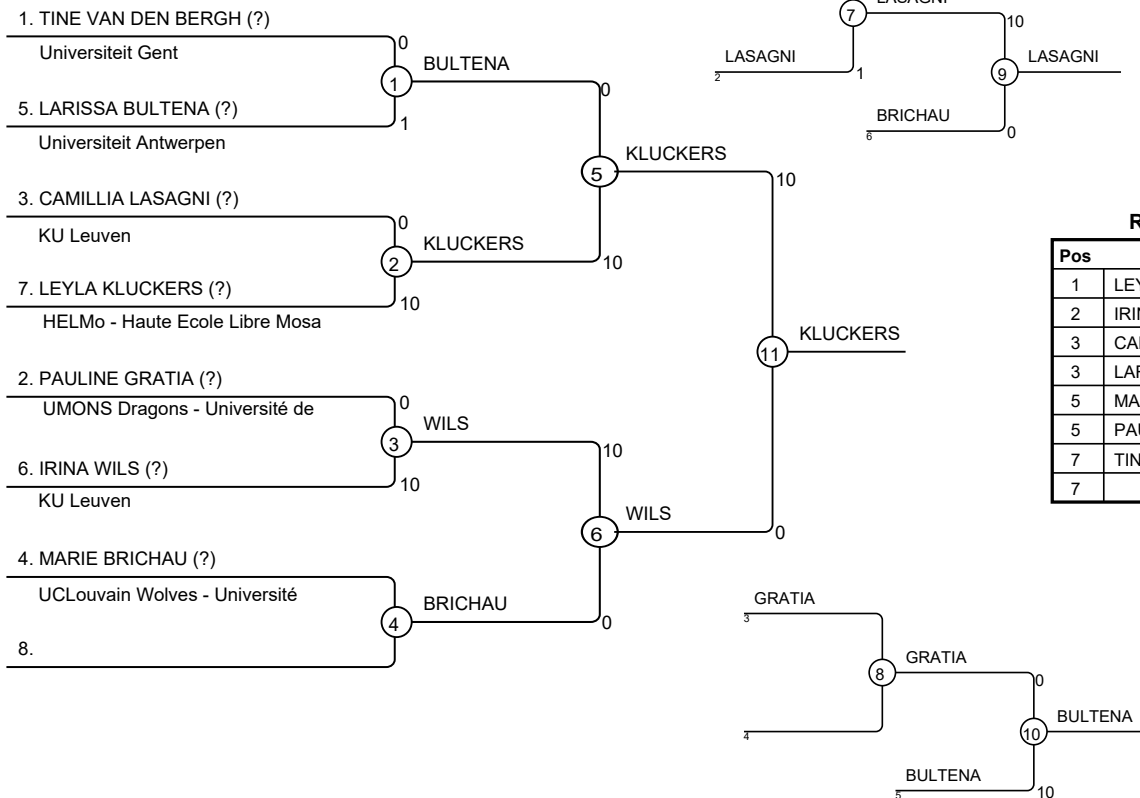

Results

Pos	Name
1	LEYLA KLUCKERS HELMo - Haute Ecole Libre Mos
2	IRINA WILS KU Leuven
3	CAMILLIA LASAGNI KU Leuven
3	LARISSA BULTENA Universiteit Antwerpen
5	MARIE BRICHAU UCLouvain Wolves - Université
5	PAULINE GRATIA UMONS Dragons - Université de
7	TINE VAN DEN BERGH Universiteit Gent
7	

FSUB Judo Championship 07/12/2022 D-78

Competitors: 2

Competitors

#	Name	Club	1	2	1	2	1	2	Wins	Pts	Pos
1	LUCIE HECQ	UCLouvain Wolves - Université	0		10		1		2	11	1
2	MANON BUCHALLET	UCLouvain Wolves - Université	10		0		0		1	10	2

Matches

Match	White		Blue		Result	Time
1	LUCIE HECQ	1	2	MANON BUCHALLET	0 - 10	1:44
2	LUCIE HECQ	1	2	MANON BUCHALLET	10 - 0	2:41
3	LUCIE HECQ	1	2	MANON BUCHALLET	1 - 0	4:17

Results

Pos	Name
1	LUCIE HECQ UCLouvain Wolves - Université
2	MANON BUCHALLET UCLouvain Wolves - Université

B.U.S.F. - F.S.U.B.



FSUB Judo Championship 07/12/2022 D+78

Competitors: 3

Competitors

#	Name	Club	1	2	3	Wins	Pts	Pos
1	FRAN NAESSENS (?) Hogeschool VIVES			10	10	2	20	1
2	AISSATOU SARR (?) ULiège (Liège) - Université de		0		10	1	10	2
3	MAËLYSS SCHEMAN (?) ULB Owls - Université libre de		0	0		0	0	3

Matches

Match	White			Blue	Result	Time
1	FRAN NAESSENS	1	2	AISSATOU SARR	10 - 0	1:23
2	FRAN NAESSENS	1	3	MAËLYSS SCHEMAN	10 - 0	1:15
3	AISSATOU SARR	2	3	MAËLYSS SCHEMAN	10 - 0	3:23

Results

Pos	Name
1	FRAN NAESSENS Hogeschool VIVES
2	AISSATOU SARR ULiège (Liège) - Université de
3	MAËLYSS SCHEMAN ULB Owls - Université libre de

B.U.S.F. - F.S.U.B.



FSUB Judo Championship 07/12/2022 H-60

Competitors: 9

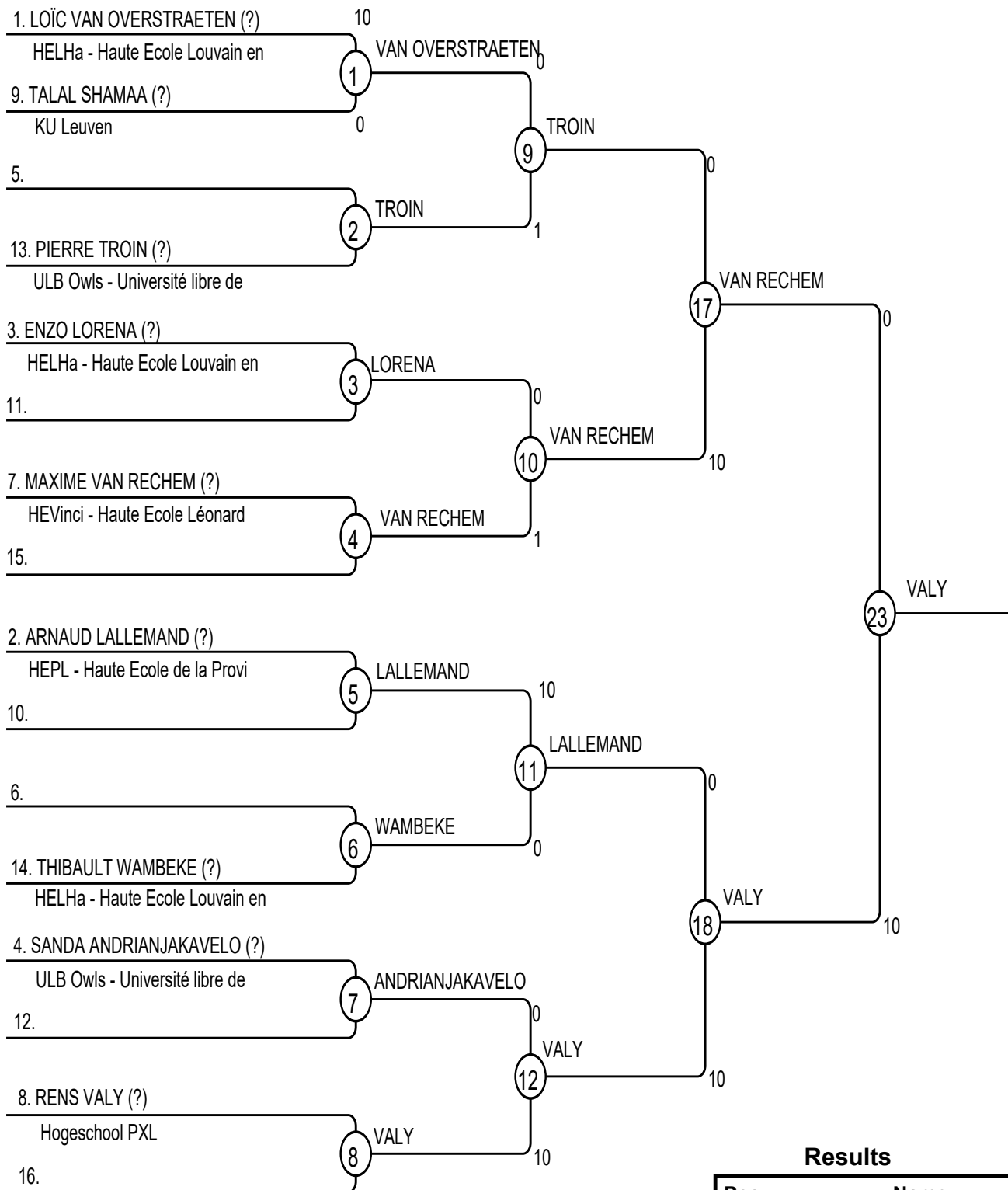

Results

Pos	Name
1	RENS VALY Hogeschool PXL
2	MAXIME VAN RECHEM HEVinci - Haute Ecole Léonard
3	ENZO LORENA HELHa - Haute Ecole Louvain en
3	PIERRE TROIN ULB Owls - Université libre de
5	ARNAUD LALLEMAND HEPL - Haute Ecole de la Province
5	THIBAUT WAMBEKE HELHa - Haute Ecole Louvain en
7	LOÏC VAN OVERSTRAETEN HELHa - Haute Ecole Louvain en
7	SANDA ANDRIANJAKAVELO ULB Owls - Université libre de

B.U.S.F. - F.S.U.B.



REPECHAGE

FSUB Judo Championship 07/12/2022 H-60

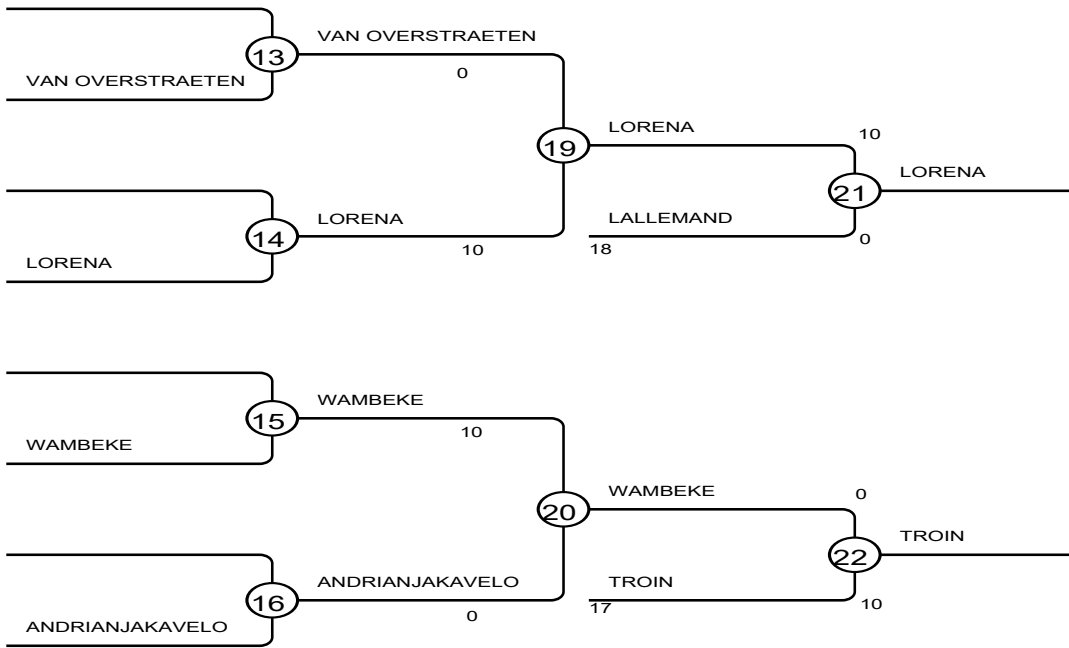

FSUB Judo Championship 07/12/2022 H-66

Competitors: 10

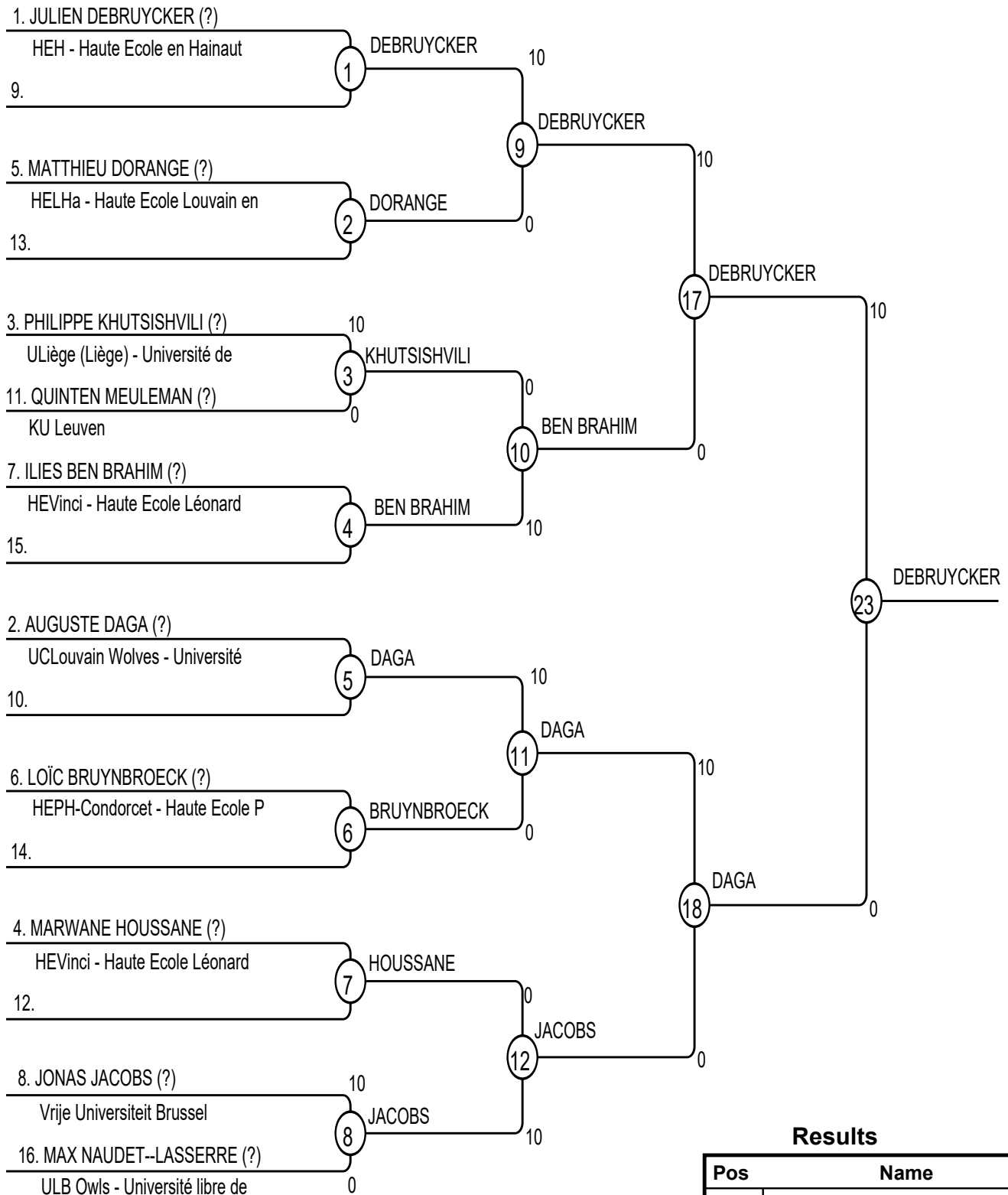

Results

Pos	Name
1	JULIEN DEBRUYCKER HEH - Haute Ecole en Hainaut
2	AUGUSTE DAGA UCLouvain Wolves - Université de Louvain
3	JONAS JACOBS Vrije Universiteit Brussel
3	ILIES BEN BRAHIM HEVinci - Haute Ecole Léonard
5	PHILIPPE KHUTSISHVILI ULiège (Liège) - Université de Liège
5	MAX NAUDET--LASSERRE ULB Owls - Université libre de Bruxelles
7	MATTHIEU DORANGE HELHa - Haute Ecole Louvain en Hainaut
7	LOÏC BRUYNBROECK HEPH-Condorcet - Haute Ecole Polytechnique de Condorcet

B.U.S.F. - F.S.U.B.



REPECHAGE

FSUB Judo Championship 07/12/2022 H-66

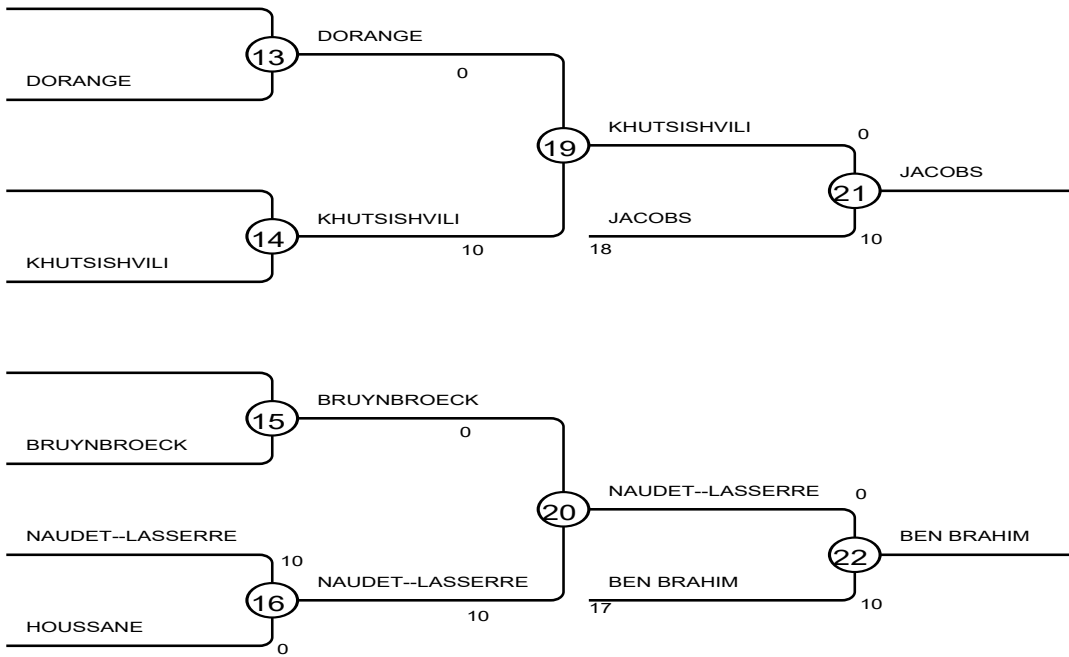

FSUB Judo Championship 07/12/2022 H-73

Competitors: 13

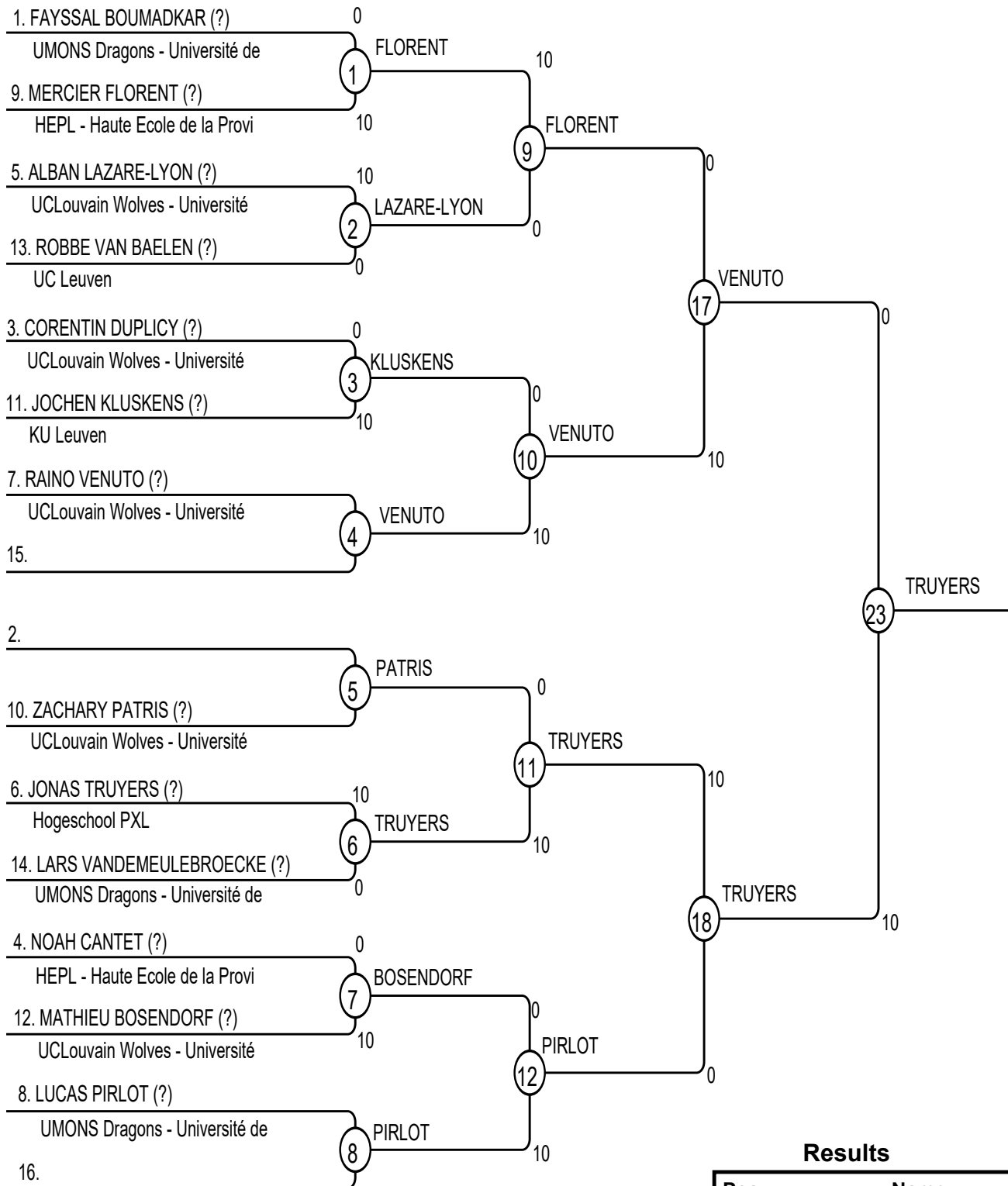

Results

Pos	Name
1	JONAS TRUYERS Hogeschool PXL
2	RAINO VENUTO UCLouvain Wolves - Univ
3	ALBAN LAZARE-LYON UCLouvain Wolves
3	MATHIEU BOSENDORF UCLouvain Wolv
5	LUCAS PIRLOT UMONS Dragons - Univer
5	MERCIER FLORENT HEPL - Haute Ecole
7	JOCHEN KLUSKENS KU Leuven
7	LARS VANDEMEULEBROECKE UMONS

B.U.S.F. - F.S.U.B.



REPECHAGE

FSUB Judo Championship 07/12/2022 H-73

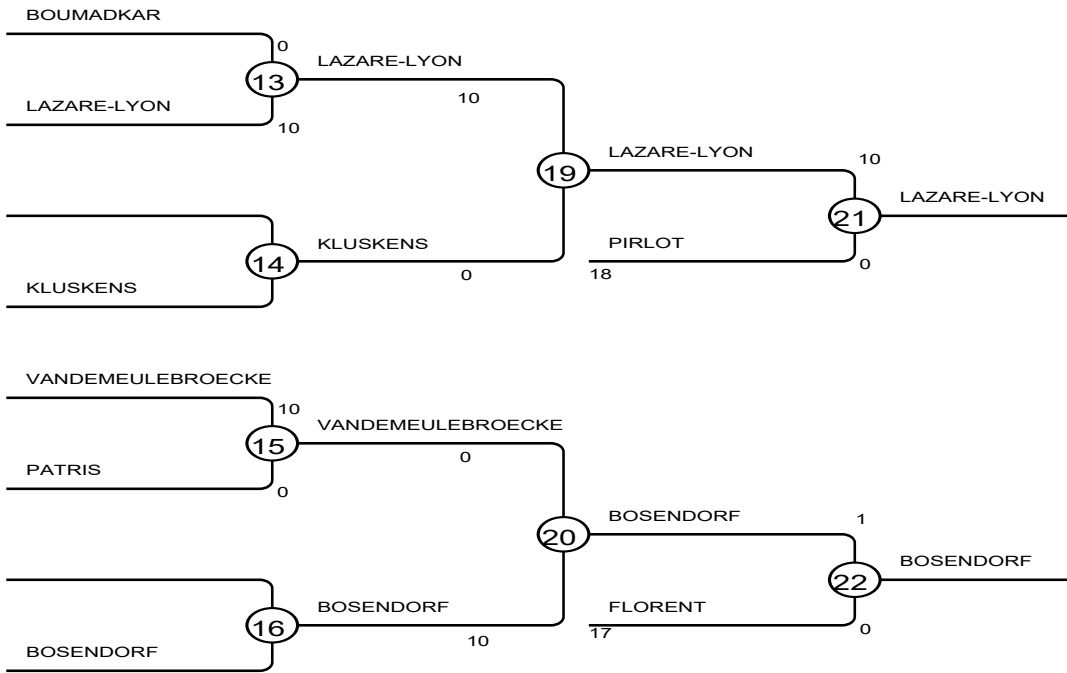

FSUB Judo Championship 07/12/2022 H-81

B.U.S.F. - F.S.U.B.



Competitors: 7

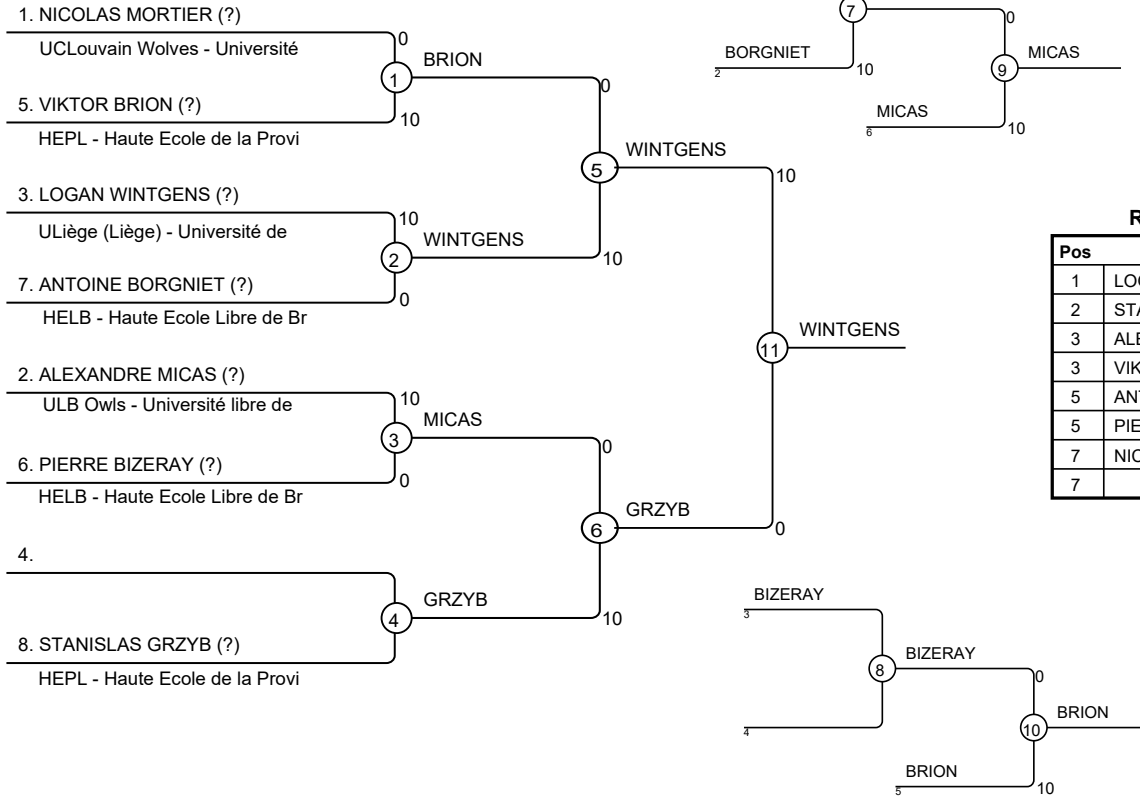

Results

Pos	Name
1	LOGAN WINTGENS ULiège (Liège) - Université de
2	STANISLAS GRZYB HEPL - Haute Ecole de la Provi
3	ALEXANDRE MICAS ULB Owls - Université libre de
3	VIKTOR BRION HEPL - Haute Ecole de la Provi
5	ANTOINE BORGNIET HELB - Haute Ecole Libre de Br
5	PIERRE BIZERAY HELB - Haute Ecole Libre de Br
7	NICOLAS MORTIER UCLouvain Wolves - Université
7	

FSUB Judo Championship 07/12/2022 H-90

Competitors: 5

Competitors

#	Name	Club	1	2	3	4	5	Wins	Pts	Pos
1	BRAM PUSSIG (?) KU Leuven			10	0	10	10	3	30	2
2	TOM VANDEPITTE (?) Hogeschool VIVES		0		0	10	0	1	10	4
3	VICTOR GOEMAN (?) KU Leuven- Technologicampus G		10	10		10	10	4	40	1
4	THIBAUT VANHEEDE (?) HELHa - Haute Ecole Louvain en		0	0	0		0	0	0	5
5	ERWAN VERSTRAETE (?) HEPL - Haute Ecole de la Provi		0	10	0	10		2	20	3

Matches

Match	White	Blue	Result	Time
1	THIBAUT VANHEEDE 4	ERWAN VERSTRAETE 5	0 - 10	1:25
2	BRAM PUSSIG 1	TOM VANDEPITTE 2	10 - 0	0:41
3	VICTOR GOEMAN 3	THIBAUT VANHEEDE 4	10 - 0	0:28
4	BRAM PUSSIG 1	ERWAN VERSTRAETE 5	10 - 0	0:42
5	TOM VANDEPITTE 2	VICTOR GOEMAN 3	0 - 10	0:26
6	BRAM PUSSIG 1	THIBAUT VANHEEDE 4	10 - 0	0:14
7	VICTOR GOEMAN 3	ERWAN VERSTRAETE 5	10 - 0	0:35
8	TOM VANDEPITTE 2	THIBAUT VANHEEDE 4	10 - 0	0:40
9	BRAM PUSSIG 1	VICTOR GOEMAN 3	0 - 10	3:04
10	TOM VANDEPITTE 2	ERWAN VERSTRAETE 5	0 - 10	3:24

Results

Pos	Name
1	VICTOR GOEMAN KU Leuven- Technologicampus G
2	BRAM PUSSIG KU Leuven
3	ERWAN VERSTRAETE HEPL - Haute Ecole de la Provi
4	TOM VANDEPITTE Hogeschool VIVES
5	THIBAUT VANHEEDE HELHa - Haute Ecole Louvain en

B.U.S.F. - F.S.U.B.



FSUB Judo Championship 07/12/2022 H-100

Competitors: 4

Competitors

#	Name	Club	1	2	3	4	Wins	Pts	Pos
1	ALEXY HALLOT (?) HELHa - Haute Ecole Louvain en			0	0	0	0	0	4
2	TENGIZ ALOUYAN (?) HELMo - Haute Ecole Libre Mosa		1		0	0	1	1	3
3	PJOTR DEBRUYNE (?) Hogeschool West-Vlaanderen		10	10		10	3	30	1
4	OLIVIER DELEFORTRIE (?) UCLouvain Wolves - Université		10	10	0		2	20	2

Matches

Match	White		Blue		Result	Time
1	ALEXY HALLOT	1	2	TENGIZ ALOUYAN	0 - 1	4:00
2	PJOTR DEBRUYNE	3	4	OLIVIER DELEFORTRIE	10 - 0	3:12
3	ALEXY HALLOT	1	3	PJOTR DEBRUYNE	0 - 10	1:06
4	TENGIZ ALOUYAN	2	4	OLIVIER DELEFORTRIE	0 - 10	1:00
5	ALEXY HALLOT	1	4	OLIVIER DELEFORTRIE	0 - 10	1:02
6	TENGIZ ALOUYAN	2	3	PJOTR DEBRUYNE	0 - 10	0:22

Results

Pos	Name
1	PJOTR DEBRUYNE Hogeschool West-Vlaanderen
2	OLIVIER DELEFORTRIE UCLouvain Wolves - Université
3	TENGIZ ALOUYAN HELMo - Haute Ecole Libre Mosa
4	ALEXY HALLOT HELHa - Haute Ecole Louvain en

B.U.S.F. - F.S.U.B.



FSUB Judo Championship 07/12/2022 H+100

Competitors: 5

Competitors

#	Name	Club	1	2	3	4	5	Wins	Pts	Pos
1	KAREL DEREERE (?) Hogeschool VIVES			0				0	0	5
2	STEVE MICHEL FOKAM BOPDA (?) HEPL - Haute Ecole de la Provi		10		10	0	0	0	0	3
3	BRANDON HAPPE (?) HEH - Haute Ecole en Hainaut			0		0		0	0	4
4	ERIC RAICK (?) HEPL - Haute Ecole de la Provi			1	10		0	1	1	2
5	AUDRIC SCHMITZ (?) HEPL - Haute Ecole de la Provi			10		10		2	20	1

Matches

Match	White		Blue		Result	Time
1	ERIC RAICK	4	5	AUDRIC SCHMITZ	0 - 10	3:30
2	KAREL DEREERE	1	2	STEVE MICHEL FOKAM BOPDA	0 - 10	1:59
3	BRANDON HAPPE	3	4	ERIC RAICK	0 - 10	2:21
4	KAREL DEREERE	1	5	AUDRIC SCHMITZ	-	
5	STEVE MICHEL FOKAM BOPDA	2	3	BRANDON HAPPE	10 - 0	0:31
6	KAREL DEREERE	1	4	ERIC RAICK	-	
7	BRANDON HAPPE	3	5	AUDRIC SCHMITZ	-	
8	STEVE MICHEL FOKAM BOPDA	2	4	ERIC RAICK	0 - 1	4:00
9	KAREL DEREERE	1	3	BRANDON HAPPE	-	
10	STEVE MICHEL FOKAM BOPDA	2	5	AUDRIC SCHMITZ	0 - 10	1:56

Results

Pos	Name
1	AUDRIC SCHMITZ HEPL - Haute Ecole de la Provi
2	ERIC RAICK HEPL - Haute Ecole de la Provi
3	STEVE MICHEL FOKAM BOPDA HEPL - Haute Ecole de la Provi
4	
5	

B.U.S.F. - F.S.U.B.



Résultats du Championnat FSUB
de Judo Individuel
Salle de l'UMONS
Mercredi 8 mars 2023



FSUB Judo Teams Championship 2023

TAPIS

P1

	Equipe	1	2	3	4	5	Points	VE	VI	DE	DI	Place
1	UCLouvain Wolves 1		2 7 61	2 7 70	2 8 80		6	22	211	2	20	1
2	HEPL / Umons	0 1 10		0 2 20	2 5 41		2	8	71	15	141	3
3	Associatie KU Leuven	0 1 10	2 6 60		2 6 60		4	13	130	11	110	2
4	HELHA	0 0 0	0 2 20	0 2 20			0	4	40	19	181	4
5							0	0	0	0	0	

Poule de 3 : 1/2 2/3 1/3

Poule de 4 : 1/2 3/4 1/3 2/4 1/4 2/3

Poule de 5 : 1/2 3/4 1/5 2/4 3/5 1/4 2/3 4/5 1/3 2/5

FSUB Judo Teams Championship 2023

TAPIS

P2

	Equipe	1	2	3	4	5	Points	VE	VI	DE	DI	Place
1	UCLouvain Wolves 2		0 0 0	0 2 20			0	2	20	13	130	3
2	Associatie UGent	2 8 80		2 7 61			4	15	141	1	10	1
3	ULiège (Liège)	2 5 50	0 1 10				2	6	60	9	81	2
4							0	0	0	0	0	
5							0	0	0	0	0	

Poule de 3 : 1/2 2/3 1/3

Poule de 4 : 1/2 3/4 1/3 2/4 1/4 2/3

Poule de 5 : 1/2 3/4 1/5 2/4 3/5 1/4 2/3 4/5 1/3 2/5

FSUB Judo Teams Championship 2023 - Finales

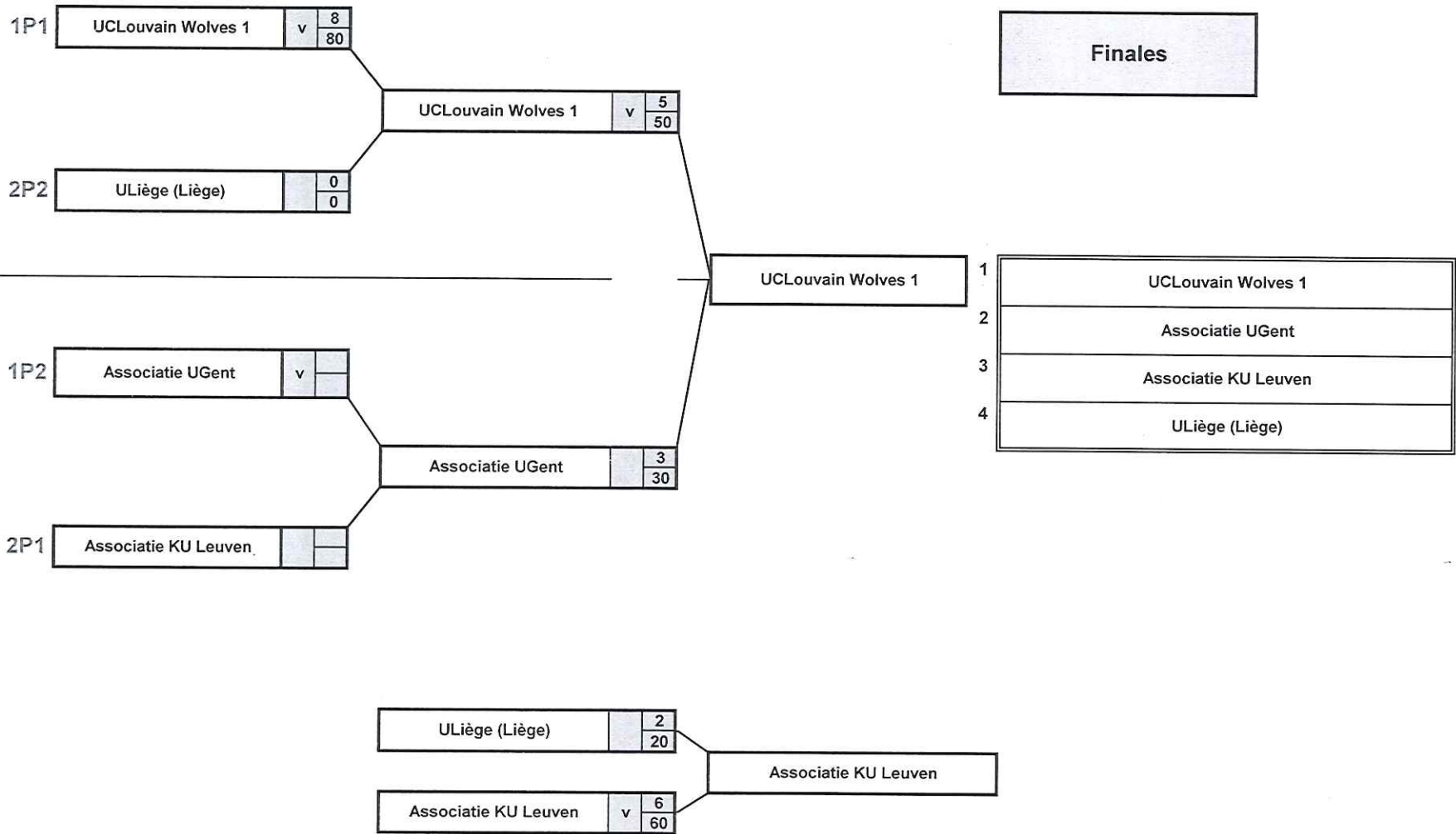

Résultats du Championnat FSUB de Natation

Piscine de Groenenhoek- Anvers

Mardi 14 mars 2023



BSK Zwemmen 2022-23
Groenenhoek Berchem, 14/3/2023

1 - dinsdag 14 maart 2023

14/03/2023 - 15:00

Programmanr. 1 Dames, 100m vrije slag alg. leeftijdsgroep
14/03/2023 Resultaten

Punten: FINA 2023

Rang		Inschr.	Tijd	Pnt
1.	Feys Jutta	UGENT	59.09	58.62
2.	Gheleyens Juliette	UCLOUVAIN	1:00.00	59.38
3.	Moerman Helena	UGENT	59.27	1:01.08
4.	Van Olmen Jlll	KU LEUVEN	1:10.00	1:01.84
5.	Thiry Emma	UCLOUVAIN	1:05.00	1:03.42
6.	Keunen Kyara	ERM-KMS	1:12.00	1:06.88
7.	Blothiaux Aline	UCLOUVAIN	1:06.00	1:08.96
8.	Verstrepen Axelle	KU LEUVEN	1:20.00	1:10.12
9.	Giesberts Mirte	KU LEUVEN	1:11.00	1:13.56
10.	Decaesteker Marion	ERM-KMS	1:15.00	1:17.38
11.	Hasti Khodakarimi	UANTWERPEN	1:20.00	1:32.82
DIS	Papp Rita	HELHA	1:30.00	
	<i>SW 10.2 - Niet de volledige afstand gezwommen</i>			
NG.ZA	Delahaut Mollet Romane	ULB	1:06.00	

Programmanr. 2 Heren, 100m vrije slag alg. leeftijdsgroep
14/03/2023 Resultaten

Punten: FINA 2023

Rang		Inschr.	Tijd	Pnt
1.	Willems Bruno	UGENT	52.35	51.31
2.	Camps Roeland	KU LEUVEN	54.90	53.17
3.	Do Duy Thang Tanguy	UCLOUVAIN	53.65	54.16
4.	Coorevits Simon	HOWEST	53.37	54.74
5.	Derez Matthias	KU LEUVEN	51.83	55.43
6.	Kalogeropoulos Zeno	UGENT	51.57	56.90
7.	Marichal Jarno	HOWEST	53.64	56.92
8.	Denison Antoine	UCLOUVAIN	54.00	56.97
9.	Dekimpe Dries	KU LEUVEN	1:00.00	57.41
10.	Serverius Jordi	UGENT	53.68	58.88
11.	Leman Arnaud	HELHA	57.79	59.30
12.	Limbioul Thomas	ERM-KMS	1:00.00	59.31
13.	Denolf Ward	ERM-KMS	58.00	59.32
14.	Loncour Brieuc	UCLOUVAIN	1:00.00	59.62
15.	Obreno Arthur	HOGENT	NT	1:00.36
16.	Masbahi Théo	ULB	1:05.00	1:07.16

BSK Zwemmen 2022-23
Groenenhoek Berchem, 14/3/2023

Programmanr. 3
14/03/2023

Dames, 100m schoolslag

alg. leeftijdsgroep
Resultaten

Punten: FINA 2023

Rang		Inschr.	Tijd	Pnt
1.	Van Pouvke Hanne	UGENT	1:14.69	1:15.48
2.	Delmotte Elodie	UCLouvain	1:16.50	1:17.08
3.	Vavritska Victoria	UGENT	1:15.68	1:18.42
4.	Eliard Tania	UCLouvain	1:19.00	1:21.22
5.	Böselers Natasja	AP	1:22.00	1:21.45
6.	Goris Resy	KU LEUVEN	1:20.09	1:21.57
7.	Sebille Chloé	HELHA	1:23.47	1:25.86
8.	Heyrbaut Lise	KU LEUVEN	1:45.00	1:31.89
9.	Coppin Emilie	KU LEUVEN	1:45.00	1:32.96
10.	Van Espen Inès	UCLouvain	1:30.00	1:41.65
11.	Beck Anna Lisa	ULB	2:30.00	1:46.73

Programmanr. 4
14/03/2023

Heren, 100m schoolslag

alg. leeftijdsgroep
Resultaten

Punten: FINA 2023

Rang		Inschr.	Tijd	Pnt
1.	Vandendorpe Emile	UGENT	1:05.81	1:07.70
2.	Kyriakides Niels	UANTWERPEN	1:08.91	1:09.07
3.	Delbecque Tore	HOGENT	1:05.54	1:09.42
4.	Moyaert Theodore	UGENT	1:06.84	1:10.09
5.	Vanderhulst Tobe	KU LEUVEN	1:09.76	1:12.63
6.	Moore Matthias	UGENT	1:11.56	1:14.60
7.	Denef Grégoire	UCLouvain	1:18.18	1:15.56
8.	Noerens Andres	HOGENT	1:14.96	1:15.93
9.	Debongnie Nathan	UCLouvain	1:10.08	1:16.03
10.	Camps Viktor	KU LEUVEN	1:12.66	1:16.45
11.	Denolf Ward	ERM-KMS	1:15.00	1:17.30
12.	Fegar Nathan	HELHA	1:20.00	1:19.97
13.	Deprez Lander	KU LEUVEN	1:18.75	1:20.87
14.	Delroisse Clément	UCLouvain	NT	1:26.49
15.	Scokart Romain	HELHA	1:30.00	1:37.05

Programmanr. 5
14/03/2023

Dames, 200m wisselslag

alg. leeftijdsgroep
Resultaten

Punten: FINA 2023

Rang		Inschr.	Tijd	Pnt
1.	Feys Jutta	UGENT	2:26.10	2:29.32
2.	Borremans Lotte	UGENT	2:31.95	2:33.69
3.	De Heyder Lot	HOGENT	2:40.00	2:41.90
4.	Delaruelle Camille	HELHA	2:49.26	2:56.02
5.	De Meulemeester Nadège	UCLouvain	3:00.00	3:10.34

BSK Zwemmen 2022-23
Groenenhoek Berchem, 14/3/2023

Programmanr. 6 Heren, 200m wisselslag alg. leeftijdsgroep
14/03/2023 Resultaten

Punten: FINA 2023

Rang		Inschr.	Tijd	Pnt
1.	Vandamme Hugo	HEPH-CONDO	2:08.01	2:10.38
2.	Swillen Timon	KU LEUVEN	2:01.44	2:10.64
3.	Marichal Seppe	KU LEUVEN	2:19.00	2:15.01
4.	Van Eetvelt Mattias	UCLOUVAIN	2:17.00	2:18.74
5.	Cauchie Hugo	UCLOUVAIN	2:23.00	2:19.37
6.	Baeckelmans Jarne	ERM-KMS	2:40.00	2:25.44
7.	Coche Hadrien	UCLOUVAIN	2:25.54	2:26.70
8.	Houtevelt Kyllian	ULB	2:23.59	2:29.16
9.	Nieto Rodriguez Alexander	KU LEUVEN	2:50.00	2:34.91
NG.ZA	Caerts Xander	UANTWERPEN	2:44.20	

Programmanr. 7 Dames, 100m rugslag alg. leeftijdsgroep
14/03/2023 Resultaten

Punten: FINA 2023

Rang		Inschr.	Tijd	Pnt
1.	Gries Laure	HEVINCI	1:03.39	1:05.47
2.	Demeyere Anouk	HOWEST	1:05.58	1:08.17
3.	Serverius Femke	UGENT	1:06.46	1:09.05
4.	Wabelle Anna	KU LEUVEN	1:06.19	1:13.16
5.	Van Varenberg Merel	HOGENT	1:07.48	1:13.46
6.	Remy-Paquay Mazarine	ERM-KMS	1:09.00	1:13.85
7.	Verberk Britt	KU LEUVEN	1:14.05	1:14.75
8.	Rondeau Lola	UCLOUVAIN	1:14.00	1:18.74
9.	Vankevelaer Nele	KU LEUVEN	1:24.00	1:21.13

Programmanr. 8 Heren, 100m rugslag alg. leeftijdsgroep
14/03/2023 Resultaten

Punten: FINA 2023

Rang		Inschr.	Tijd	Pnt
1.	Balhaut Augustin	UCLOUVAIN	58.78	1:00.11
2.	Camps Roeland	KU LEUVEN	1:00.00	1:00.62
3.	Boudchich Ilyas	UGENT	1:02.51	1:01.42
4.	Verbeek Mats	KU LEUVEN	1:05.00	1:07.08
5.	Janssens Florian	ULB	1:09.00	1:07.31
6.	Limbioul Thomas	ERM-KMS	1:06.00	1:07.50
7.	Herman Cian	UGENT	1:03.00	1:08.79
8.	Dacheux Pierre	UCLOUVAIN	1:05.70	1:10.41
9.	Canan Yusuf	UCLOUVAIN	1:09.51	1:10.99
10.	Vekemans Aaron	ERM-KMS	1:17.00	1:11.01
11.	Van Hauwaert Joachim	UCLOUVAIN	1:15.00	1:15.39
12.	Nieto Rodriguez Alexander	KU LEUVEN	1:50.00	1:15.96
NG.ZA	Heuninck Stijn	UGENT	57.60	

BSK Zwemmen 2022-23
Groenenhoek Berchem, 14/3/2023

Programmanr. 9
14/03/2023

Dames, 50m schoolslag

alg. leeftijdsgroep
Resultaten

Punten: FINA 2023

Rang		Inschr.	Tijd	Pnt
1.	Gheleyns Juliette	UCCLOUVAIN	35.00	33.80
2.	Van Pouvke Hanne	UGENT	33.28	34.28
3.	Vavritska Victoria	UGENT	34.75	35.47
4.	Delmotte Elodie	UCCLOUVAIN	35.50	36.29
5.	Böseler Natasja	AP	37.05	36.99
6.	Verstappen Emma	KU LEUVEN	40.07	37.75
7.	Eliard Tania	UCCLOUVAIN	37.04	37.78
8.	Delaruelle Camille	HELHA	38.04	40.40
9.	Heyrbaut Lise	KU LEUVEN	45.00	42.13
10.	Plasschaert Freya	ERM-KMS	49.00	42.82
	Coppin Emilie	KU LEUVEN	45.00	42.82
12.	Beck Anna Lisa	ULB	1:00.00	46.53
13.	Kitamura Maya	ULB	47.00	46.80
14.	Van de Weghe Yseult	HELHA	55.00	53.80
NG.ZA	Lemonnier Karen	HELHA	35.00	

Programmanr. 10
14/03/2023

Heren, 200m schoolslag

alg. leeftijdsgroep
Resultaten

Punten: FINA 2023

Rang		Inschr.	Tijd	Pnt
1.	Vandendorpe Emile	UGENT	2:26.09	2:30.66
2.	Claesen Tijs	KU LEUVEN	2:30.00	2:33.22
3.	Delbecque Tore	HOGENT	2:24.57	2:40.73
4.	Coche Hadrien	UCCLOUVAIN	2:43.00	2:42.46
5.	Debongnie Nathan	UCCLOUVAIN	2:35.28	2:44.13
6.	Houtevelt Kyllian	ULB	2:37.78	2:45.42
7.	Dacheux Pierre	UCCLOUVAIN	2:42.00	2:51.64
8.	Deprez Lander	KU LEUVEN	2:54.28	3:02.40

Programmanr. 11
14/03/2023

Dames, 100m vlinderslag

alg. leeftijdsgroep
Resultaten

Punten: FINA 2023

Rang		Inschr.	Tijd	Pnt
1.	Daniels Lise	ARTEVELDE	1:08.19	1:09.15
2.	Borremans Lotte	UGENT	1:10.47	1:11.35
3.	Verstappen Emma	KU LEUVEN	1:24.00	1:16.11
4.	Wellens Merel	KU LEUVEN	1:22.09	1:16.93
5.	Dom Elize	KU LEUVEN	1:23.44	1:21.02

BSK Zwemmen 2022-23
Groenenhoek Berchem, 14/3/2023

Programmanr. 12
14/03/2023

Heren, 100m vlinderslag

alg. leeftijdsgroep
Resultaten

Punten: FINA 2023

Rang		Inschr.	Tijd	Pnt
1.	Vandamme Hugo	HEPH-CONDO	55.39	56.63
2.	Swillen Timon	KU LEUVEN	54.73	58.64
3.	Baeckelmans Jarne	ERM-KMS	56.00	58.74
4.	Verbeek Bram	KU LEUVEN	1:03.00	1:00.86
5.	Leroux Wout	UGENT	1:01.03	1:02.23
6.	Cauchie Hugo	UCLOUVAIN	59.69	1:04.40
7.	Denison Antoine	UCLOUVAIN	1:00.80	1:04.61
8.	Dugardin Gaucelin	UCLOUVAIN	1:10.00	1:07.42
9.	De Zutter Jason	KU LEUVEN	1:17.89	1:17.01
NG.ZA	Caerts Xander	UANTWERPEN	1:07.84	
NG.ZA	Serverius Jordi	UGENT	59.47	

Programmanr. 13
14/03/2023

Dames, 50m vrije slag

alg. leeftijdsgroep
Resultaten

Punten: FINA 2023

Rang		Inschr.	Tijd	Pnt
1.	Moerman Helena	UGENT	27.64	28.10
2.	Peeters Birthe	KU LEUVEN	28.52	28.76
3.	Thiry Emma	UCLOUVAIN	30.00	28.92
4.	Goris Resy	KU LEUVEN	29.48	29.55
5.	Watelle Anna	KU LEUVEN	28.17	29.66
6.	Keunen Kyara	ERM-KMS	33.00	30.47
7.	Blothiaux Aline	UCLOUVAIN	31.00	31.02
8.	De Heyder Lot	HOGENT	30.00	31.10
9.	Janvier Zoé	ULB	30.00	31.83
10.	Kaur Anmol	ERM-KMS	40.00	33.01
11.	Villeret Sophie	ULB	34.00	34.05
12.	Calewaert Tanne	ERM-KMS	40.00	35.07
13.	Van Espen Inès	UCLOUVAIN	36.00	35.11
14.	Decaesteker Marion	ERM-KMS	35.00	35.61
15.	Van de Weghe Yseult	HELHA	40.00	42.80
NG.ZA	Lemonnier Karen	HELHA	35.00	
NG.ZA	Lamotte Eva	UANTWERPEN	29.30	

Programmanr. 14
14/03/2023

Heren, 200m vrije slag

alg. leeftijdsgroep
Resultaten

Punten: FINA 2023

Rang		Inschr.	Tijd	Pnt
------	--	---------	------	-----

BSK Zwemmen 2022-23
Groenenhoek Berchem, 14/3/2023

Programmanr. 14, Heren, 200m vrije slag

1.	Willems Bruno	UGENT	1:57.05	1:56.93
2.	Marichal Seppe	KU LEUVEN	2:02.00	2:01.80
3.	Coorevits Simon	HOWEST	1:57.98	2:02.96
4.	Van Eetvelt Mattias	UCLOUVAIN	2:02.00	2:08.05
5.	Herteleer Jonas	UGENT	1:57.30	2:09.18
6.	Leroux Wout	UGENT	2:01.96	2:11.41
7.	Loncour Brieuc	UCLOUVAIN	2:05.00	2:15.02
8.	Baffrey Xavier	UCLOUVAIN	2:15.00	2:19.97
9.	Dekimpe Dries	KU LEUVEN	2:15.00	2:30.15
	Vanderhulst Tobe	KU LEUVEN	2:06.26	2:30.15

Programmanr. 15
14/03/2023

Dames, 50m rugslag

alg. leeftijdsgroep
Resultaten

Punten: FINA 2023

Rang		Inschr.	Tijd	Pnt
1.	Gries Laure	HEVINCI	29.75	31.20
2.	Demeyere Anouk	HOWEST	31.05	31.58
3.	Serverius Femke	UGENT	30.83	33.28
4.	Remy-Paquay Mazarine	ERM-KMS	30.00	33.57
5.	Verberk Britt	KU LEUVEN	34.22	34.26
6.	Van Varenberg Merel	HOGENT	31.34	34.71
7.	Dom Elize	KU LEUVEN	38.23	35.06
8.	Rondeau Lola	UCLOUVAIN	34.00	36.97
9.	Vankevelaer Nele	KU LEUVEN	39.00	38.00
10.	Villeret Sophie	ULB	38.00	40.93
11.	Plasschaert Freya	ERM-KMS	47.00	42.94
12.	Kitamura Maya	ULB	45.00	45.05
13.	Hasti Khodakarimi	UANTWERPEN	55.00	47.74
14.	Papp Rita	HELHA	1:00.00	1:00.01

Programmanr. 16
14/03/2023

Heren, 200m rugslag

alg. leeftijdsgroep
Resultaten

Punten: FINA 2023

Rang		Inschr.	Tijd	Pnt
1.	Balhaut Augustin	UCLOUVAIN	2:07.15	2:11.37
2.	Do Duy Thang Tanguy	UCLOUVAIN	2:08.86	2:13.74
3.	Herman Cian	UGENT	2:17.19	2:25.07
4.	Verbeek Mats	KU LEUVEN	2:25.00	2:31.32
5.	De Zutter Jason	KU LEUVEN	2:37.61	2:59.57
6.	Delroisse Clément	UCLOUVAIN	NT	3:05.19

BSK Zwemmen 2022-23
Groenenhoek Berchem, 14/3/2023

Programmanr. 17
14/03/2023

Dames, 50m vlinderslag

alg. leeftijdsgroep
Resultaten

Punten: FINA 2023

Rang			Inschr.	Tijd	Pnt
1.	Daniels Lise	ARTEVELDE	29.72	30.04	
2.	Van der Velpen Emma	KU LEUVEN	33.20	31.20	
3.	Brosens Sarah	KU LEUVEN	33.33	31.81	
4.	Sebille Chloé	HELHA	32.07	33.00	
	Cornelissen Dali	KU LEUVEN	33.33	33.00	
6.	De Meulemeester Nadège	UCLOUVAIN	37.00	37.10	
NG.ZA	Lamotte Eva	UANTWERPEN	29.50		
NG.ZA	Delahaut Mollet Romane	ULB	35:00.00		

Programmanr. 18
14/03/2023

Heren, 50m vrije slag

alg. leeftijdsgroep
Resultaten

Punten: FINA 2023

Rang			Inschr.	Tijd	Pnt
1.	Bomans Jan	UGENT	26.00	24.75	
	Boudchich Ilyas	UGENT	24.36	24.75	
3.	Verbeek Bram	KU LEUVEN	24.80	24.84	
4.	Kyriakides Niels	UANTWERPEN	24.30	24.95	
5.	Derez Matthias	KU LEUVEN	23.57	25.44	
6.	Marichal Jarno	HOWEST	24.26	25.45	
7.	Moore Matthias	UGENT	24.69	26.00	
8.	Leman Arnaud	HELHA	27.29	26.06	
9.	Camps Viktor	KU LEUVEN	25.40	26.23	
	Janssens Florian	ULB	26.40	26.23	
11.	Vekemans Aaron	ERM-KMS	26.00	26.87	
	Noerens Andres	HOGENT	26.77	26.87	
13.	Canan Yusuf	UCLOUVAIN	27.77	27.74	
14.	Penneman Alexandre	ERM-KMS	31.00	27.76	
15.	Fegar Nathan	HELHA	28.30	27.98	
16.	Baffrey Xavier	UCLOUVAIN	28.00	28.01	
17.	Van Hauwaert Joachim	UCLOUVAIN	27.50	28.10	
18.	Dugardin Gaucelin	UCLOUVAIN	28.88	28.79	
19.	Masbahi Théo	ULB	29.00	29.54	
20.	Vancanneyt Matthias	ERM-KMS	36.00	30.46	
21.	Rachidi Nizar	ULB	30.00	31.56	
22.	Nebbou Samir	HELHA	NT	51.61	
NG.ZA	Obreno Arthur	HOGENT	27.00		

BSK Zwemmen 2022-23
Groenenhoek Berchem, 14/3/2023

Programmanr. 19 Dames, 4 x 50m wisselslag alg. leeftijdsgroep
14/03/2023 Resultaten

Punten: FINA 2023

Rang		Inschr.	Tijd	Pnt
1.	Universiteit Gent 1	UGENT	NT	2:06.36
2.	KU Leuven 1	KU LEUVEN	NT	2:11.21
3.	Université catholique de Louvain 1	UCLOUVAIN	NT	2:11.94
4.	KU Leuven 2	KU LEUVEN	NT	2:17.71
5.	Université catholique de Louvain 2	UCLOUVAIN	NT	2:27.45
6.	Haute Ecole Louvain en Hainaut 1	HELHA	NT	3:03.38
NG.ZA	Université libre de Bruxelles 1	ULB	NT	

Programmanr. 20 Heren, 4 x 50m wisselslag alg. leeftijdsgroep
14/03/2023 Resultaten

Punten: FINA 2023

Rang		Inschr.	Tijd	Pnt
1.	KU Leuven 1	KU LEUVEN	NT	1:48.96
2.	Universiteit Gent 1	UGENT	NT	1:51.46
3.	Université catholique de Louvain 1	UCLOUVAIN	NT	1:52.81
4.	Universiteit Gent 2	UGENT	NT	1:54.40
5.	Ecole Royale Militaire - Koninklijke MilitairERM-KMSI		NT	1:56.58
6.	KU Leuven 2	KU LEUVEN	NT	1:56.74
7.	Université catholique de Louvain 2	UCLOUVAIN	NT	2:00.96

BSK Zwemmen 2022-23
Groenenhoek Berchem, 14/3/2023

Programmanr. 20, Heren, 4 x 50m wisselslag, alg. leeftijdsgroep

Rang			Inschr.	Tijd	Pnt
8.	Université libre de Bruxelles 1	ULB	NT	2:07.33	
9.	Haute Ecole Louvain en Hainaut 1	HELHA	NT	2:36.48	

Programmanr. 21
14/03/2023

Dames, 4 x 50m vrije slag

alg. leeftijdsgroep
Resultaten

Punten: FINA 2023

Rang			Inschr.	Tijd	Pnt
1.	Universiteit Gent 1	UGENT	NT	1:53.23	
2.	KU Leuven 2	KU LEUVEN	NT	1:54.91	
3.	Université catholique de Louvain 1	UCLOUVAIN	NT	1:57.07	
4.	KU Leuven 1	KU LEUVEN	NT	2:01.47	
5.	Ecole Royale Militaire - Koninklijke MilitairERM-KMSI		NT	2:06.80	
6.	Université catholique de Louvain 2	UCLOUVAIN	NT	2:15.57	
NG.ZA	Université libre de Bruxelles 1	ULB	NT		
BM	Haute Ecole Louvain en Hainaut 1	HELHA	NT	2:44.07	

Programmanr. 22
14/03/2023

Heren, 4 x 50m vrije slag

alg. leeftijdsgroep
Resultaten

Punten: FINA 2023

Rang			Inschr.	Tijd	Pnt
------	--	--	---------	------	-----

BSK Zwemmen 2022-23
Groenenhoek Berchem, 14/3/2023

Programmanr. 22, Heren, 4 x 50m vrije slag

1.	Universiteit Gent 1	UGENT	NT	1:38.57
2.	KU Leuven 1	KU LEUVEN	NT	1:38.97
3.	Université catholique de Louvain 1	UCLOUVAIN	NT	1:41.43
4.	Universiteit Gent 2	UGENT	NT	1:44.05
5.	KU Leuven 2	KU LEUVEN	NT	1:44.91
6.	Université catholique de Louvain 2	UCLOUVAIN	NT	1:48.62
7.	Université libre de Bruxelles 1	ULB	NT	1:56.69
8.	Haute Ecole Louvain en Hainaut 1	HELHA	NT	2:30.91

Programmanr. 23
14/03/2023

Gemengd, 10 x 50m vrije slag

alg. leeftijdsgroep
Resultaten

Punten: FINA 2023

Rang		Inscr.	Tijd	Pnt
1.	Universiteit Gent 1	UGENT	NT	4:22.96
2.	KU Leuven 1	KU LEUVEN	NT	4:25.93
3.	Université catholique de Louvain 1	UCLOUVAIN	NT	4:33.88

BSK Zwemmen 2022-23
Groenenhoek Berchem, 14/3/2023

Programmanr. 23, Gemengd, 10 x 50m vrije slag, alg. leeftijdsgroep

Rang		Inscr.	Tijd	Pnt
4.	Ecole Royale Militaire - Koninklijke MilitairERM-KMSI	NT	4:55.36	
5.	KU Leuven 2	KU LEUVEN	NT	4:57.53
6.	Université catholique de Louvain 2	UCLOUVAIN	NT	4:58.75

Résultats du Championnat FSUB de Padel

Padel 4U2 à Gent

Vendredi 21 avril 2023



RESULTATEN BSK PADEL - 21 APRIL - GENT

Reeks A						Reeks B					
A	Mats	Priem	Rob	Priem	KULeuven - UGent	A	Antoine	Willermain	Henri	Gasparon	KULeuven - campus Brussel
B	Evert	Verbesselt	Mauro	Fol	KULeuven	B	Miguel	Iglesias	Haroon	Tharwat	KULeuven
C	Miel	Sweerman	De Smedt	Louie	Hogeschool Gent	C	Rune	Vierendeels	Noémi	Sermant	Hogeschool Gent
D	Tibo	De Vylder	Thomas	Denis	KULeuven	D	Anton	Olieslagers	Pauwel	Dewulf	KULeuven

Reeks A				Reeks B			
Terrein 1	Uitslag	Terrein 2	Uitslag	Terrein 3	Uitslag	Terrein 4	Uitslag
A - B	4-6, 4-6	C - D	0-6, 1-6	B - D	4-6, 3-6	C - A	6-2, 6-4
B - C	6-1, 6-3	A - D	1-6, 2-6	D - A	5-7, 4-6	C - B	7-6, 6-2
C - A	4-6, 6-7	D - B	6-2, 6-2	C - D	7-5, 4-6, 6-10	A - B	6-0, 6-3

 Studentensport
Vlaanderen

 ASEUS
Association Sportive de l'Enseignement
Universitaire et Supérieur ASBL



Reeks A						Reeks B							
	A	B	C	D	TOTAAL		A	B	C	D	TOTAAL	Aantal gewonnen sets	Aantal gewonnen games
A		0	3	0	3	A		3	0	3	6	4	31
B	3		3	0	6	B	0		0	0	0	0	
C	0	0		0	0	C	3	3		0	6	5	
D	3	3	3		9	D	0	3	3		6	4	32

1ste plaats	Tibo+Thomas	KULeuven
2de plaats	Evert+Mauro	KULeuven
3de plaats	Mats+Rob	KUL/UGent
4de plaats	Miel + Louie	HoGent

1ste plaats	Noémi + Rune	HoGent
2de plaats	Pauwel+Anton	KULeuven
3de plaats	Antoine+Henri	KULeuven
4de plaats	Miguel+Haroon	KULeuven

Résultats du Championnat FSUB de Tennis de Table

KU Leuven

Lundi 20 février 2023



KU LEUVEN

BSK TAFELTENNIS 20/2/2023

RANGSCHIKKING HEREN

1	Degros	Nicolas	HEPL - Haute Ecole de la Province de Liège
2	Wuestenberg	Ethan	HEPH-Condorcet - Haute Ecole Provinciale du Hainaut - Condorcet
3	Vanvinckenroye	Matthias	Hogeschool PXL
4	Maquestiau	Martin	ULiège (Liège) - Université de Liège
5	Bilas	Clément	HELMo - Haute Ecole Libre Mosane
6	Henrard	Ulysse	UNAMUR - Université de Namur
7	Salmon	Tom	HEPL - Haute Ecole de la Province de Liège
8	Fikany	Jean Pierre	UCLouvain Wolves - Université catholique de Louvain
9	Hermans	Raf	KU Leuven
10	Guo	Xin	Universiteit Gent
11	Foguenne	Emile	UCLouvain Wolves - Université catholique de Louvain
12	Surmont	Klaas	KU Leuven
13	Poucet	Pierre	HENALLUX - Haute Ecole de Namur-Liège-Luxembourg
14	CARPENTIER	Colin	UCLouvain Wolves - Université catholique de Louvain
15	Hoez	Baptiste	UCLouvain Wolves - Université catholique de Louvain
16	Abánades Baldominos	Juan Santiago	ULiège (Liège) - Université de Liège
17	De Clercq	Tom	Odisee Hogeschool
18	Stanescu	Dan	UCLouvain Wolves - Université catholique de Louvain
19	Baurire	Thomas	UCLouvain Wolves - Université catholique de Louvain
20	Van Eetvelde	Arno	KU Leuven
21	Berteau	Matthias	ULB Owls - Université libre de Bruxelles
22	Grilli	Valentin	UNAMUR - Université de Namur
23	Turkbas	Efe	KU Leuven
24	Surmont	Floris	KU Leuven
25	Debroux	Bastien	UCLouvain Wolves - Université catholique de Louvain
26	Alloin	Clément	ULB Owls - Université libre de Bruxelles
27	Vercammen	Dries	KU Leuven
28	Alexandre-Martin	Samuel	UCLouvain Wolves - Université catholique de Louvain
29	KWAN	Oswin	ULiège (Liège) - Université de Liège
30	Christiaens	Romain	UNAMUR - Université de Namur
31	Rosée	Dorian	UCLouvain Wolves - Université catholique de Louvain
32	Stanescu	Gabriel	UCLouvain Wolves - Université catholique de Louvain
33	Minette	Benjamin	UCLouvain Wolves - Université catholique de Louvain
34	Reniers	Mathieu	UCLouvain Wolves - Université catholique de Louvain
35	Fosseur	Nicolas	ULB Owls - Université libre de Bruxelles
36	Thinnes	Romain	HE2B - Haute Ecole Bruxelles-Brabant
37	Houben	Marc	KU Leuven
38	Joertz	Arnaud	HELHa - Haute Ecole Louvain en Hainaut
39	Iu	yannik	ULB Owls - Université libre de Bruxelles
40	Petit	Joachim	ULB Owls - Université libre de Bruxelles
41	Siciliano	Giovanni	HELHa - Haute Ecole Louvain en Hainaut
42	Jursch	Natanael	KU Leuven
43	Devillet	Ludovic	UCLouvain Wolves - Université catholique de Louvain
44	Brichard	Kévin	HELHa - Haute Ecole Louvain en Hainaut
45	Fortez	Hugo	UCLouvain Wolves - Université catholique de Louvain
46	Sibille	Jeremy	UNAMUR - Université de Namur
47	Chassagne	Aurélien	ULB Owls - Université libre de Bruxelles
48	Juncheng Zhu	Juncheng	KU Leuven
49	Penne	Yanthe	KU Leuven

BSK TAFELTENNIS 20/2/2023**RANGSCHIKKING DAMES**

1	Tschirr	Margaux	UNAMUR - Université de Namur
2	buelens	stella	ULB Owls - Université libre de Bruxelles
3	Eerdekens	Hanne	KU Leuven
4	Masson	Catherine	HELHa - Haute Ecole Louvain en Hainaut
5	Lejeune	Aloïse	UCLouvain Wolves - Université catholique de Louvain
6	Quanten	Lisa	KU Leuven
7	Bierny	Aurore	HELHa - Haute Ecole Louvain en Hainaut
8	Zixin	Zhao	KU Leuven
9	Claes	Laura	Universiteit Hasselt

BSK TAFELTENNIS 20/2/2023**RANGSCHIKKING RECREANTEN**

1	Melicherová	Lívia	KU Leuven
2	Cascioli	Lorenzo	KU Leuven
3	Coppens	Alexandre	HENALLUX - Haute Ecole de Namur-Liège-Luxembourg
4	Abumariam	Fares	KU Leuven
5	Thiry	Quentin	UCLouvain Wolves - Université catholique de Louvain
6	Chiron	Zacharie	KU Leuven
7	Atri Mukherjee	Atri	KU Leuven
8	Coenen	Jonah	KU Leuven
9	Zalchartchenko	Manon	HELHa - Haute Ecole Louvain en Hainaut
10	Marinelli	Hugo	UNAMUR - Université de Namur
11	demolin	cyril	UCLouvain Wolves - Université catholique de Louvain
12	de Gheldere	Louis	HELHa - Haute Ecole Louvain en Hainaut

Résultats du Championnat FSUB de Triathlon

Seneffe

Dimanche 28 mai 2023



PLACE	Doss.	Nom Prénom	Sx	Pl.S	pl/cat	Nat.	T1	Vélo	T2	Course	Arrivée	Institution scolaire
1	2	SIMONS, wouter	M	1	1	20:25	02:58	1:02:55	02:30	32:25	2:01:13	Hogeschool PXL
2	64	DOUGLAS, Jack	M	2	1	19:08	02:49	1:03:54	02:58	35:46	2:04:35	HEVinci - Haute Ecole Léonard de Vinci
3	83	BERTHOLOMÉ, Arthur	M	3	2	21:20	03:27	1:01:57	02:54	37:09	2:06:47	HELMo - Haute Ecole Libre Mosane
4	89	BAKKER, Yentel	M	4	2	21:46	03:28	1:02:23	02:59	37:00	2:07:36	KU Leuven
7	14	DEMAZY, Guillaume	M	7	3	22:26	03:32	1:02:21	03:09	37:49	2:09:17	UCLouvain Wolves - Université catholique de Louvain
9	98	LOUIS, Arthur	M	9	4	21:32	03:44	1:04:12	03:09	38:50	2:11:27	ULiège (Liège) - Université de Liège
11	94	GOUDEMANT, Tom	M	11	5	22:04	04:01	1:06:35	03:14	37:46	2:13:40	UCLouvain Wolves - Université catholique de Louvain
14	65	GUILLAUME, maxime	M	14	6	19:46	02:59	1:08:28	03:03	40:41	2:14:57	HEVinci - Haute Ecole Léonard de Vinci
16	30	MAROT, Augustin	M	16	7	25:54	03:32	1:06:57	03:16	37:47	2:17:26	HELMo - Haute Ecole Libre Mosane
18	92	VERMEIRE, Martin	M	18	9	23:43	03:41	1:06:06	03:20	41:25	2:18:15	HELMo - Haute Ecole Libre Mosane
20	29	JACQUEMIN, Antoine	M	20	9	24:58	03:17	1:10:05	03:24	37:18	2:19:02	UCLouvain Wolves - Université catholique de Louvain
24	108	BIERNAUX, Dorian	M	24	11	24:26	03:46	1:09:35	03:08	39:27	2:20:22	HE2B - Haute Ecole Bruxelles-Brabant
48	146	RECKELBUS, Antoine	M	46	13	31:36	04:41	1:12:32	04:05	41:29	2:34:23	UCLouvain Wolves - Université catholique de Louvain
60	132	JOVENEAU, Thibaut	M	56	15	29:13	05:33	1:09:53	04:53	47:38	2:37:10	UCLouvain Wolves - Université catholique de Louvain
66	32	DELHEZ, Nicolas	M	61	27	25:56	04:54	1:15:41	04:19	48:34	2:39:24	UCLouvain Wolves - Université catholique de Louvain
69	110	COOLS, Mathias	M	64	16	32:18	04:45	1:18:24	04:01	41:42	2:41:10	UCLouvain Wolves - Université catholique de Louvain
72	130	INSTALLÉ, Mathias	M	66	17	29:51	05:09	1:11:50	04:18	50:10	2:41:18	HELHa - Haute Ecole Louvain en Hainaut
76	9	LO BUE, Thomas	M	70	18	29:47	05:06	1:16:25	04:51	46:43	2:42:52	HELHa - Haute Ecole Louvain en Hainaut
82	118	DEHOUX, Adrien	M	76	21	32:34	04:32	1:15:16	04:38	48:23	2:45:23	HELHa - Haute Ecole Louvain en Hainaut
84	82	VAN ESPEN, Inès	F	7	1	26:58	03:55	1:22:01	03:29	50:08	2:46:31	UCLouvain Wolves - Université catholique de Louvain
89	45	CHARLET, Victor	M	82	22	33:58	05:02	1:13:42	04:20	51:42	2:48:44	HEPH-Condorcet - Haute Ecole Provinciale du Hainaut - Condorcet
90	141	MORTIER, Julien	M	83	23	32:42	04:45	1:14:20	04:51	52:14	2:48:52	HEVinci - Haute Ecole Léonard de Vinci
100	35	LELOUP, Marine	F	9	1	28:45	04:28	1:22:49	04:02	54:41	2:54:45	USLB Dragons - Université Saint-Louis Bruxelles
107	52	PETERS-DICKIE, Jean-Louis	M	95	38	27:14	04:34	1:17:54	05:04	1:03:10	2:57:56	UCLouvain Wolves - Université catholique de Louvain
108	150	TRINH, Mercy	F	13	2	27:51	03:15	1:27:51	03:37	56:04	2:58:38	ULiège (Liège) - Université de Liège
112	151	VAN CAUWENBERG, Valentin	M	97	39	32:10	05:57	1:31:38	04:18	49:52	3:03:55	ULiège (Liège) - Université de Liège
119	114	DE DEURWAERDER, Nicolas	M	102	41	33:04	06:02	1:31:47	03:13	55:18	3:09:24	HELHa - Haute Ecole Louvain en Hainaut
134	25	PFISTER, Léonie	F	22	6	39:40	06:08	1:42:20	05:21	1:08:23	3:41:52	HELHa - Haute Ecole Louvain en Hainaut
135	113	CZYZEWSKI, Noé	M	113	31	46:49	06:16	1:35:21	04:38	1:13:23	3:46:27	HENALLUX - Haute Ecole de Namur-Liège-Luxembourg
DNF	122	DUCHÊNE, Arthur	M	-1	-1							UCLouvain Wolves - Université catholique de Louvain



Résultats des Finales FSUB
Louvain-la-Neuve le 19 avril 2023

BASKET-BALL DAMES	SCORE	VAINQUEUR
ULiège (Liège) - UGent	69 - 68	ULiège (Liège)
BASKET-BALL HOMMES		
ULiège (Liège) - UGent	98 - 79	ULiège (Liège)
FOOTBALL		
HE Vinci - UGent	5 - 0 (Forfait)	HE Vinci
FUTSAL DAMES		
HEPL - KU Leuven	5 - 7	KU Leuven
FUTSAL HOMMES		
HEPL- AUHL	4 - 6	AUHL
HANDBALL HOMMES		
HEPL - AUHL	39 - 33	HEPL
HANDBALL DAMES		
UCLouvain Wolves - AUHL	19 - 18	UCLouvain Wolves
HOCKEY HOMMES		
ULB Owls - KU Leuven	2 - 0	ULB Owls
HOCKEY DAMES		
UCLouvain Wolves - KU Leuven	8 - 0	UCLouvain Wolves
RUGBY XV		
HE Vinci - KU Leuven	62 - 0	HE Vinci
TENNIS DAMES		
HE Vinci - KU Leuven	3 - 0 (Forfait)	HE Vinci
TENNIS HOMMES		
UCLouvain Wolves 1 - AUGent	8 - 0	UCLouvain Wolves 1
VOLLEY- BALL DAMES		
UCLouvain Wolves - UGent	2 - 3 (25/20-25/18-18/25-22/25-10/15)	UGent
VOLLEY- BALL HOMMES		
UCLouvain Wolves - Thomas More	0 - 3 (26/28-21/25-18/25)	Thomas More
WATERPOLO		
HEPL - AUGent	7 - 28	AUGent



FLOORBALL

FSUBCHAMPIONSHIP

Championnat de Belgique de l'Enseignement
Universitaire et Supérieur

DATE

Mercredi 1er mars 2023

LIEU

UGent Sportcomplex (GUSB)
3, Watersportlaan
9000 Gent

HEURE

Echauffement dès 12h30
Début des rencontres à 13h30

Minimum 8 joueurs pour s'inscrire au
championnat.

Fin des inscriptions
le 24 février à 12h00



ANNULÉ

Tu veux t'inscrire à la compétition ?

Scanne le QR Code et complète le formulaire !

Plus d'infos

www.aseus.be



En partenariat avec



B.U.S.F. - F.S.U.B.



RUGBY VII CHAMPIONNAT

FSUBCHAMPIONSHIP

Championnat de Belgique de l'Enseignement
Universitaire et Supérieur

DATE

Jeudi 9 Mars 2023

LIEU

Kituro Rugby Club
5000 bis, Avenue des Jardins
1030 Schaerbeek

HEURE

Entre 10H30 et 19H
Horaire adapté selon le nombre
d'inscriptions

Fin des inscriptions
le 6 mars à 12h00



Tu veux t'inscrire à la compétition ?

Scanne le QR Code et complète le formulaire !

Plus d'infos

www.aseus.be



En partenariat avec



LIGUE BELGE
FRANCOPHONE
DE RUGBY

KSS Studentensport
Vlaanderen



FÉDÉRATION
WALLONIE-BRUXELLES

Adeps
FÉDÉRATION WALLONIE-BRUXELLES



ASEUS
Association Belge de l'Enseignement
Universitaire et Supérieur

B.U.S.F. - F.S.U.B.





RUGBY VII TOURNOI

FSUBCHAMPIONSHIP

Championnat de Belgique de l'Enseignement
Universitaire et Supérieur

DATE

Jeudi 20 octobre 2022

Kituro, P...
naerbeek

ANNULÉ

HEURE

Dès 10h30

Horaire adapté selon le nombre
d'inscriptions

Fin des inscriptions
le 17 octobre à 12h

Tu veux t'inscrire à la compétition ?

Scanne le QR Code et complète le formulaire !

Plus d'infos

www.aseus.be



En partenariat avec



LIGUE BELGE
FRANCOPHONE
DE RUGBY



Studentensport
Vlaanderen



FÉDÉRATION
WALLONIE-BRUXELLES



Adeps
FÉDÉRATION WALLONIE-BRUXELLES



ASEUS
Association Belge de l'Enseignement
Supérieur et Universitaire de Rugby

B.U.S.F. - F.S.U.B.



ULTIMATE FRISBEE OUTDOOR

FSUBCHAMPIONSHIP

Championnats de Belgique de l'Enseignement
Universitaire et Supérieur

DATE

Dimanche 23 avril 2023

LIEU

Terrain extérieur F3
Centre Sportif du Blocry
11, Place des Sports
1348 Louvain-la-Neuve

HEURE

Début des compétitions à 10H30
Horaire adapté selon le nombre
d'inscriptions

**Fin des inscriptions
le 17 avril à 12h00**

ANNULÉ

Tu veux t'inscrire à la compétition ?

Scanne le QR Code et complète le formulaire !

Plus d'infos

www.aseus.be



En partenariat avec



SSS Studentensport
Vlaanderen

UCLouvain

F3 FÉDÉRATION
WALLONIE-BRUXELLES

Adeps
FÉDÉRATION WALLONIE-BRUXELLES

ASEUS
Association Sportive de l'Enseignement
Universitaire et Supérieur ASBL

B.U.S.F. - F.S.U.B.

